

17" Industrial Panel PC

PPC-5170A-H61

Intel® Core™ i7/ i5/ i3, Pentium® and Celeron® Processor



Features

- High brightness TFT-LCD panel with LED backlight
- Multiple storage options: 2.5" SATA HDD, CF slot, and mSATA
- Dual Ethernet provides continuous network service and allows sharing among different workgroups in two different subnets
- Optional PCI / PCIe x1 expansion slot
- Optional slim type CD-ROM drive bay
- Robust aluminum front bezel and metal casing
- IP 66 compliant front panel for PPC-5170A-H61
- IEI One Key Recovery solution allows you to create rapid OS backup and recovery (over 4GB storage capacity)

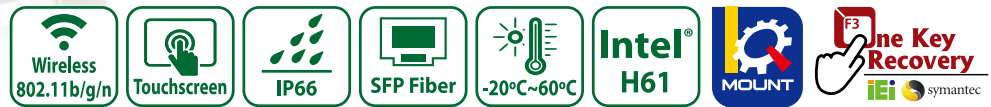

Specifications

Model		PPC-5170A-H61
Display	LCD Size	17"
	Max. Resolution	1280(W) x 1024(H)
	Brightness (cd/m ²)	350
	Contrast Ratio	800 : 1
	LCD Color	16.7M
	Pixel Pitch (mm) (HxV)	0.264(H) x 0.264(V)
	Viewing Angle (V/H)	170°/ 160°
	Backlight MTBF (hrs)	50000
Touch	Touchscreen	5-wire resistive type with RS-232 interface
	Touch Controller	DMC 9000
Motherboard	SBC	POS-H61
	CPU	2nd/3rd generation Intel® Core™ i7/ i5/ i3, Pentium® and Celeron® processor, up to TDP 65W CPU
	Chipset	Intel® H61
	RAM	Two 204-pin DDR3 SO-DIMM slots (Max. 16GB)
	Ethernet	Realtek RTL8111E PCIe GbE controller supporting ASF 2.0
	Audio Codec	Realtek ALC662 audio codec
I/O Ports and Switches		4 x RS-232 COM port
		1 x RS-232/422/485 port
		2 x RJ-45 for LAN port
		4 x USB 2.0, 2 x USB 3.1 Gen 1 (5Gb/s) on rear
		1 x VGA port
Drive Bay	HDD Driver Bay	1 x 2.5" SATA HDD bay with anti-shock
	SSD	CF Type II, mSATA (SATA2 signal)
	CD-ROM Driver Bay	SATA slim type CD-ROM bay
Expansion Slot		Either 1 x PCI slot or 1 x PCIe slot
		1 x PCIe Mini card
Physical	Front Panel Construction	Aluminum
	Chassis Construction	Heavy-duty steel
	Mounting	Panel, wall, rack, stand and arm (VESA 100 mm x 100 mm)
	Front Panel Color	Silver (Pantone 8001C)
	Dimensions (WxHxD) (mm)	452 x 356 x 115
	Cut Out Dimensions (WxH) (mm)	426 x 331
	Net/Gross Weight	8 kg / 12 kg
	IP Rating	Front IP66 compliant
Environment	Operating Temperature	-20°C ~ 60°C
	Storage Temperature	-30°C ~ 70°C
	System Cooling	Active with fan
	Vibration	5~17Hz, 0.1 double amplitude displacement 17~640Hz 1.5G acceleration peak to peak
	Shock	10G acceleration part to part (11ms)
Power Supply	AC Input	AC input ATX power supply - P/N: 63000-ACEA622A166-RS - 220W power supply - Input: 90VAC~264VAC, 50/60Hz - Output (max.): 3.3V@14A, 5V@16A, 12V@10A, -12V@0.8A
	DC Input	DC input ATX power supply - P/N: ACE-4520C-RS - 200W power supply - Input: 24 VDC (18~36 VDC) - Output (max.): 3.3V@12A, 5V@12A, 12V@15.4A, -12V@0.5A

Ordering Information

Part No.	Description
PPC-5170A-H61-P/R-R10	17" 350 cd/m ² SXGA panel PC with POS-H61, Intel® Pentium® G6xxT dual-core CPU (above 2.2GHz), TDP 35W, 2GB DDR3 RAM*2, Silver color, PSU ACE-A622A, touch screen, RoHS
PPC-5170AD-H61-P/R-R10	17" 350 cd/m ² SXGA panel PC with POS-H61, Intel® Pentium® G6xxT dual-core CPU (above 2.2GHz), TDP 35W, 2GB DDR3 RAM*2, Silver color, PSU ACE-4520C, touch screen, RoHS
PPC-5170A-H61-i3/R-R10	17" 350 cd/m ² SXGA panel PC with POS-H61, Intel® Core™ i3 2xxxT dual-core CPU (above 2.5GHz), TDP 35W, 2GB DDR3 RAM*2, Silver color, PSU ACE-A622A, touch screen, RoHS
PPC-5170AD-H61-i3/R-R10	17" 350 cd/m ² SXGA panel PC with POS-H61, Intel® Core™ i3 2xxxT dual-core CPU (above 2.5GHz), TDP 35W, 2GB DDR3 RAM*2, Silver color, PSU ACE-4520C, touch screen, RoHS
PPC-5170A-H61-i5/R-R10	17" 350 cd/m ² SXGA panel PC with POS-H61, Intel® Core™ i5 2xxxT dual-core CPU (above 2.7GHz), TDP 35W, 2GB DDR3 RAM*2, Silver color, PSU ACE-A622A, touch screen, RoHS
PPC-5170AD-H61-i5/R-R10	17" 350 cd/m ² SXGA panel PC with POS-H61, Intel® Core™ i5 2xxxT dual-core CPU (above 2.7GHz), TDP 35W, 2GB DDR3 RAM*2, Silver color, PSU ACE-4520C, touch screen, RoHS
PCIR-01H-R10	One PCI slot riser card
PCIER-101H-R10	One PCIe x1 slot riser card

IQ Mounting Options

Item	Part No.
Rack Mount Kit	RK-170MS-R10
Arm	ARM-31-RS
Stand	STAND-210-R11

Options

Part Number	Description
19Z00-000112-RS	IDE CD-ROM installation kit (W/O IDE cable)
41019-0393C0-00-RS	IDE HDD bracket
32200-000037-RS	25cm HDD IDE cable
EMB-WIFI-KIT01-R20	Wi-Fi module with RF cable and antenna
73400-AD7760H01-RS	Slim type SATA DVD-ROM

Packing List

Item	Part No.	Remark
SATA CD-ROM Cable	32803-000300-100-RS	Slim-line SATA 7+6P to SATA 7P/4P power, L=200/150 m
Power Cord	32000-000002-RS	European standard, 1830 mm, plug (16A, 250V), connector (10A, 250V)
Panel Mount Kit	19Z00-000024-RS	19Z00-000024-RS x10
Wall Mount Kit	41020-016102-00-RS	

Fully Integrated I/O

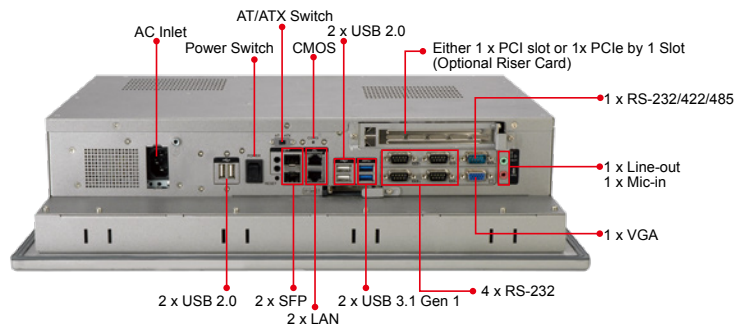

PPC-5170A-H61 Dimensions (Unit: mm)

