

RS-408



RSM-408



RS-408/RSM-408

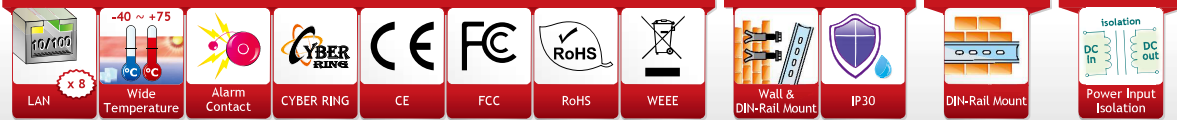

Features ▶▶▶

- Automatic MDI/MDI-X crossover for plug-and-play
- Store-and-forward architecture
- Each port supports both 10/100 Mbps speed auto negotiation
- Full duplex IEEE 802.3x and half duplex backpressure flow control
- Supports wide operating temperature -40 °C ~ +75 °C
- 3.2 Gbps high performance memory bandwidth
- Redundant Dual Power Inputs +10 V_{DC} ~ +30 V_{DC}
- Power failure alarm by relay output
- Modbus remote monitoring
- Supports Modbus OPC Server
- 2048 MAC addresses
- Frame buffer memory: 1 Mbit
- Absolutely free of software setting
- Built-in Cyber-Ring redundant technique
- DIN-Rail Mounting

Introduction

The RS-408/RSM-408 series is a 8-port Industrial Ethernet (10/100 Base-TX) Real-time Redundant Ring Switch. RS-408/RSM-408 supports 10/100M auto negotiation feature and auto MDI/MDI-X function, it can automatically switch the transmission speed (10 Mbps or 100 Mbps) for corresponding connections.

Built-in ICP DAS Cyber-Ring technique enables multiple switches to be placed into a redundant ring. Typically the switch detects and recovers from a copper link failure within approximately 20 ms – for the majority of applications, it is seamless process. The RS-408/RSM-408 series is much more easy to use and absolutely free of software setting. After unpacking the shipping case, it just takes one or two dip or rotary switch to make it work.

RS-408/RSM-408 provides two power inputs that can be connected simultaneously to live DC power sources. If one of the power inputs fails, the other live source will act as a backup to automatically support the it's power needs. And the relay output facility can deliver warning signal while power or network link failure.

Specifications

Models	RS-408	RSM-408
Technology		
Standards	IEEE 802.3, 802.3u and 802.3x	
Processing Type	Store & forward, wire speed switching	
MAC Addresses	2048	
Memory Bandwidth	3.2 Gbps	
Frame Buffer Memory	1 Mbit	
Flow Control	IEEE 802.3x flow control, back pressure flow control	
Interface		
RJ-45 Ports	10/100 Base-TX auto negotiation speed, F/H duplex mode, and auto MDI/MDI-X connection	
LED Indicators	Power, 10/100M, Link/Act, Master	
Ethernet Isolation	1500 V _{rms} 1 minute	
COM1	RS-232 (TxD, RxD and GND); Non-isolated	
COM2	RS-485 (D2+, D2-; self-tuner ASIC inside); Non-isolated	
Frame Ground for EMS Protection	Yes	
Power		
Input Voltage Range	+10 V _{dc} ~ +30 V _{dc} Redundant Dual Inputs (Isolated)	
Power Consumption	0.3 A @ 24 V _{dc}	
Protection	Power reverse polarity protection	
Frame Ground for EMS Protection	Yes	
Connector	7-Pin Removable Terminal Block	
Mechanical		
Casing	Plastic	Metal
Environmental Rating	-	IP30 Protection
Dimensions (W x L x H)	64 mm x 98 mm x 118 mm	73 mm x 102 mm x 132 mm
Installation	DIN-Rail Mounting	DIN-Rail Mounting or Wall Mounting
Environmental		
Operating Temperature	-40 °C ~ +75 °C	
Storage Temperature	-40 °C ~ +85 °C	
Ambient Relative Humidity	10% ~ 90% RH, non-condensing	
Accessories		
Option Cable	CA-090510	

Comparison Table of 8-port Real-time Redundant Ring Switch

Mode Name	RS-408	RSM-408
Input Voltage Range	+10 V _{dc} ~ +30 V _{dc}	
Casing	Plastic	Metal
Installation	DIN-Rail Mounting	DIN-Rail Mounting or Wall Mounting
Dimensions (W x L x H)	64 mm x 98 mm x 118 mm	73 mm x 102 mm x 132 mm

Applications

Redundant Power Inputs

Both power inputs can be connected simultaneously to live DC power sources. If one power source fails, the other live source will act as a backup, and automatically supplies all of RS-408/RSM-408 series power needs.

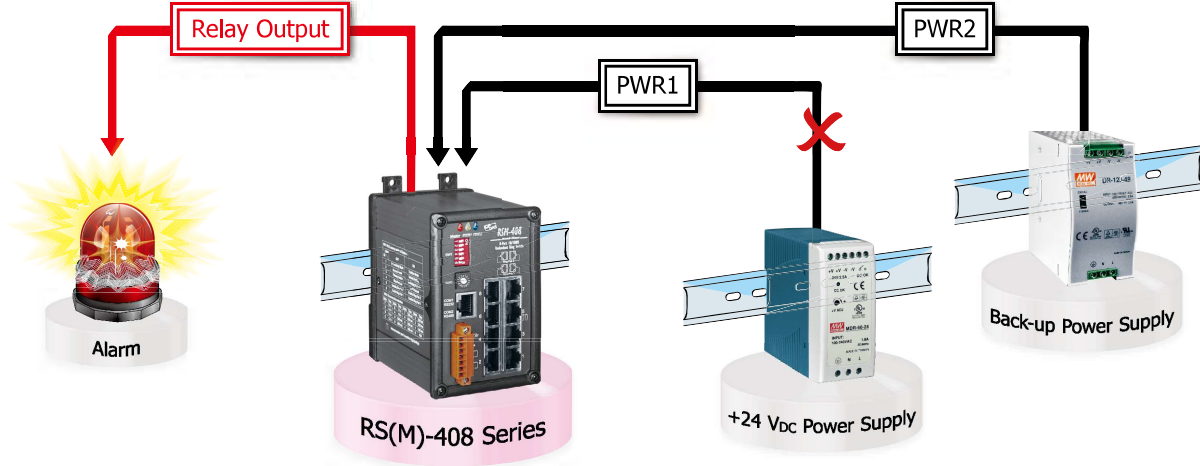

Double Ring Coupling

Double Ring Coupling is the enhanced version of Ring Coupling topology. It improves the reliability of Ring Coupling topology. In Double Ring Coupling topology, there are two coupling points providing redundant coupling path of two rings.

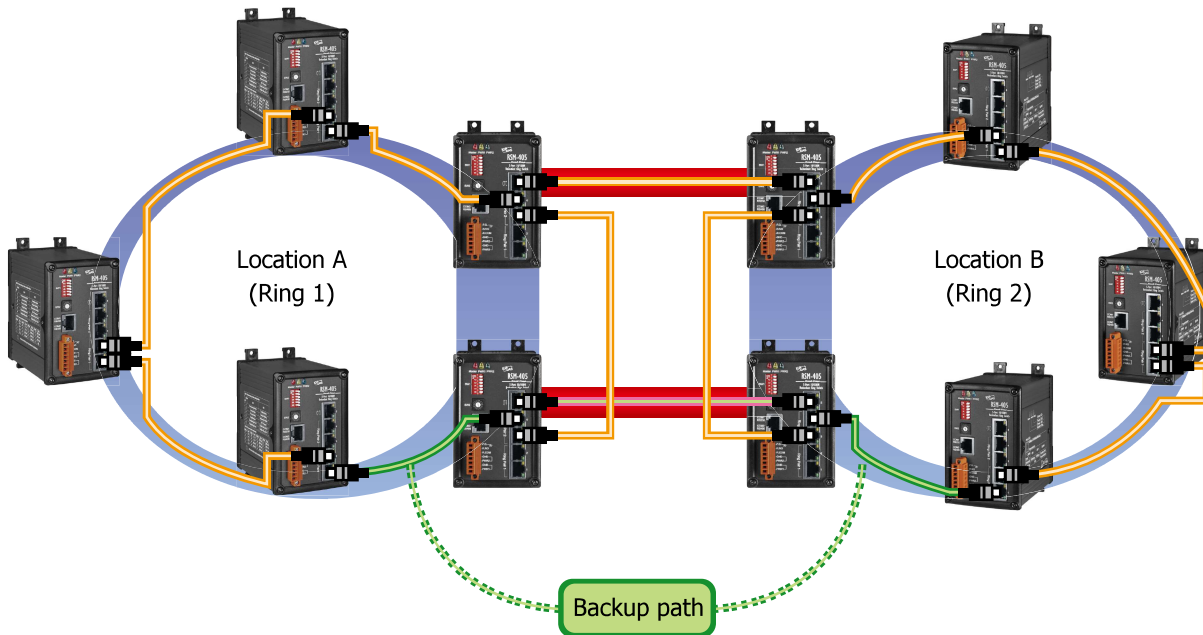

DIP/Rotary Switches

SW1: Redundancy mode configuration

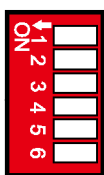

	OFF	ON
1	Redundancy Mode	Tradition Mode
2	Normal State	Default Setting
3	Primary Switch	Secondary Switch
4	Ring Protocol	STP Protocol
5	Disable Ring Pair2	Enable Ring Pair2
6	Disable Ring Pair1	Enable Ring Pair1

SW2: Max. Recovery time selection



State	Time	State	Time	State	Time
F	1.5 s	9	900 ms	3	300 ms
E	1.4 s	8	800 ms	2	200 ms
D	1.3 s	7	700 ms	1	100 ms
C	1.2 s	6	600 ms	0	N/A
B	1.1 s	5	500 ms		
A	1.0 s	4	400 ms		

LED Functions

RS/RSM-408 Series LED Indicator Functions

LED	Color	Description
Master	Red On	The switch is master of ring network
	Red Off	The switch is slave of ring network
PWR1	Orange On	Power input 1 is alive
	Orange Off	Power input 1 is offline
PWR2	Green On	Power input 2 is alive
	Green Off	Power input 2 is offline
Ethernet Port	Orange On	Link to 100 Mbps
	Orange Off	Link to 10 Mbps
	Orange Blink	Backup Port
	Green Blink	Data Transmission

Dimensions (Units: mm)

RS-408

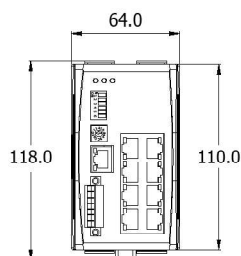

Front View

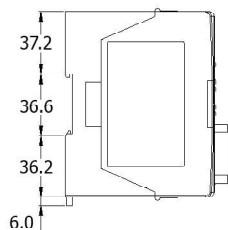

Left Side View

RSM-408

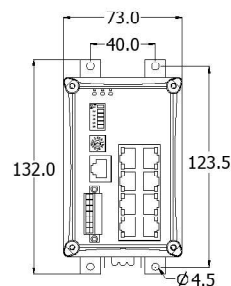

Front View

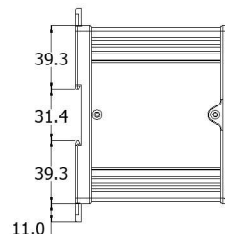

Left Side View

Ordering Information

RS-408 CR	8-port Redundant Ring Switch with Isolated Power Input +10 V _{DC} ~ +30 V _{DC} (RoHS)
RSM-408 CR	8-port Redundant Ring Switch with Isolated Power Input +10 V _{DC} ~ +30 V _{DC} , metal casing (RoHS)

Accessories

CA-090510	9-Pin Female D-Sub & RJ-45 Cable, 1 M Cable
MDR-20-24	24 V/1 A, 24 W Power Supply with DIN-Rail Mounting
MDR-60-48	48 V/1.25 A, 60 W Power Supply with DIN-Rail Mounting
DIN-KA52F	24 V/1.04 A, 25 W Power Supply with DIN-Rail Mounting
DR-120-24	24 V/5 A, 120 W Power Supply with DIN-Rail Mounting