

Marine Panel PC Series

S19A-QM87

Intel® Core™ i5 Dual-core Processor

S24A-QM87

Intel® Core™ i5 Dual-core Processor

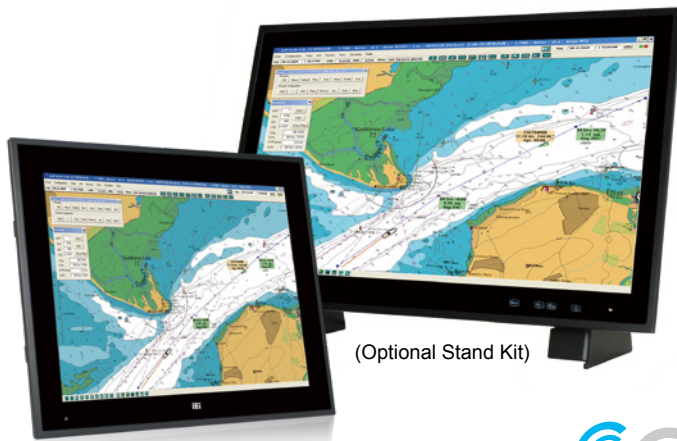

(Optional Stand Kit)

- **19" and 24" Fanless Panel PC with 4th Generation Intel® Core™ i5 Dual-core Processor**
- **-15°C ~ +55°C Wide Temperature and IP66 Protection with Flat-bezel Projected Capacitive Touchscreen**
- **Excellent Visual Performance**
 - Three independent displays
 - Full OSD function configuration
 - 0%~100% full range dimming
 - 178°/178° wide viewing angles
 - Optical bonding improves visibility under bright light (optional)
- **Isolation Protection**
 - RS-232/422/485 isolated serial ports
 - Isolated 18V ~ 36V DC input
 - 2 x Isolated CAN-bus 2.0B
- **iRIS Remote Management Module**

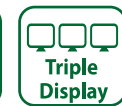

Specifications

Model		S19A-QM87	S24A-QM87
LCD	LCD Size	19"	24"
	Panel Type	PMVA	AMVA
	Max. Resolution	1280 x 1024 (5:4)	1920 x 1080 (16:9)
	Contrast Ratio	2000 : 1	5000 : 1
	Brightness (cd/m²)	300	300
	LCD Color	16.7M	16.7M
	Pixel Pitch (um)	294 x 294	276.75 x 276.75
	Viewing Angles (H-V)	178° / 178°	178° / 178°
	Backlight MTBF (HRs)	50000	50000
Touchscreen & Controller		EEX3188 (10 point) , 6H	EEX3188 (10 point) , 6H
System	SBC Model	SMB-QM87-R10	
	Chipset	Intel® QM87	
	CPU	Intel® 22nm 4th generation Mobile Core™ i5-4400E 2.7GHz processor	
	RAM	4GB 1600MHz DDR3 SDRAM (2GB*2) Two 204-pin 1600/1333 MHz dual-channel DDR3 SDRAM support up to 16GB	
Input Interfaces	I/O Ports & Switch	2 x USB 2.0	1 x Isolated 18V ~ 36V DC 3-pin terminal block
		2 x USB 3.1 Gen 1 (5Gb/s)	1 x Power button
	Expansion	1 x VGA	1 x PS2 (through Y-type cable supporting KB/MS)
		1 x DVI-D	2 x CAN-bus 2.0B, 3-pin terminal block (2.5 kv isolation protection)
		1 x HDMI	1 x DB-9 RS-232 (non-isolated) ,
		1 x Mic-in	4 x DB-9 RS-232/422/485 (2.5 kv isolation protection)
		1 x Line-out	2 x RJ-45 GbE LAN with teaming support
		1 x Line-in	(2KV isolation protection)
		2 x Antenna SMA hole (reserved)	
Ethernet Controller		GbE1: Intel® I217LM with Intel® AMT 9.0 support GbE2: Intel® I210-AT PCIe controller	
Sensor		Ambient light sensor (0% ~ 100%)	
OSD		Menu, brightness down, brightness up, LCD on/off by cap-sensor (graphics engine: Genesis STDP6038)	
Storage		2 x 2.5" SSD bay with RAID 0/1 function 1 x Accessible CFast socket	
LED Indicator		Power (power on: green; power off: orange)/storage (red, blinking)/IPMI (blue)	
Power Requirement		Isolated 24V DC (18~31.2 V DC), screw-type 3-pin terminal block	
Operating Temperature		-15°C ~ 55°C (5°F ~ 131°F)	
Storage Temperature		-20°C ~ 60°C (-4°F ~ 140°F)	
Humidity		5% to 95% RH	
Thermal Design		Fanless	
Watchdog Timer		Supports 1~255 sec. system reset	
Certifications		EMC: CE, FCC	
		Safety: DNV, IEC 60945 4th, IACS-E10, IEC 61174	
		IP rating: IP66 compliant front panel and IP22 compliant rear cover	
Housing		Front aluminum sheet metal (Black C)	
Cut-out Dimensions (L x W)		442 mm x 373 mm	576 mm x 358 mm
Dimensions (L x W x H)		463 mm x 394 mm x 113 mm	592 mm x 374 mm x 113 mm
Net Weight (kg)		9.91	13.03
Gross Weight (kg)		13.38	17.19
Vibration and Shock		IEC 60945 / DNV 2.4 compliant / IACS-E10	
Power Supply (DC Input)		DC Input ATX Power Supply	
		- P/N: 041D710-00-101-RS	
		- 150W power supply	
		- Input: 24V DC, 8-4A (max.) - Output (max.): 12V @13A	
Power Consumption		112W	117W

Ordering Information

P/N	Description
S19A-QM87i-i5/PC/4G-R11	19" 300cd/m ² SXGA marine panel PC with Intel® Mobile Core™ i5-4400E 2.7GHz CPU, 2*2GB DDR3 RAM, projected capacitive touch screen, isolated 18-36V DC, iRIS-2400 supported, R11
S24A-QM87i-i5/PC/4G-R11	24" 300cd/m ² FHD marine panel PC with Intel® Mobile Core™ i5-4400E 2.7GHz CPU, 2*2GB DDR3 RAM, projected capacitive touch screen, isolated 18-36V DC, iRIS-2400 supported, R11

Options

Item	Part No.	Description
Panel Mount Kit	PK-S19A-R10	For S19A
	PK-S24A-R10	For S24A
Desktop Stand	STAND-S24A-R10	For S19A & S24A
Ceiling Mount Kit	CEILMT-S24-R10	For S19A/S24A
HDMI Lockable Kit	HDMI-LK-R10	Universal HDMI Locking Adapter
iRIS Module	iRIS-2400-R10	IPMI 2.0 adapter card with AST2400 BMC chip for DDR3 SO-DIMM socket interface

Packing List

Item	Q'ty	Remark
S19A-QM87 or S24A-QM87	1	
Screw Pack	1	Including necessary screws
PS/2 Cable	1	Round cable; PS/2 cable
Wire Strain Band	3	Wire strain band



STAND-S24A-R10

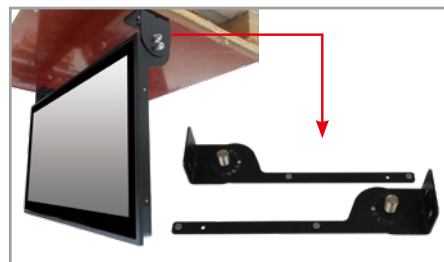

CEILMT-S24-R10

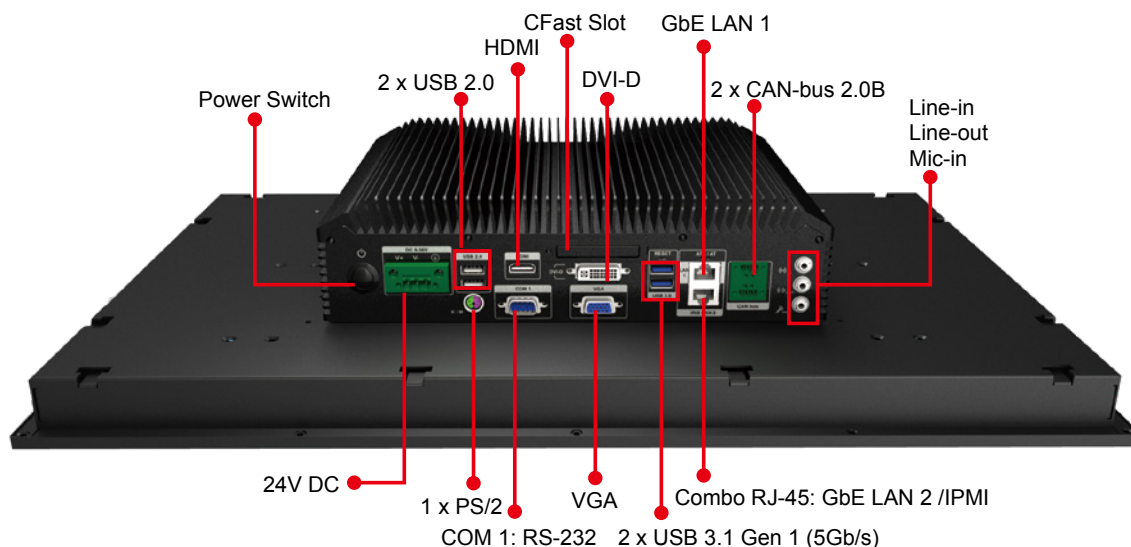

Four OSD Keys by Cap-sensor
(Menu, Brightness down, Brightness up, LCD on/off)

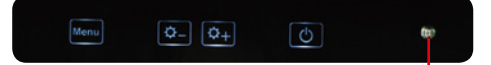

Ambient Light Sensor

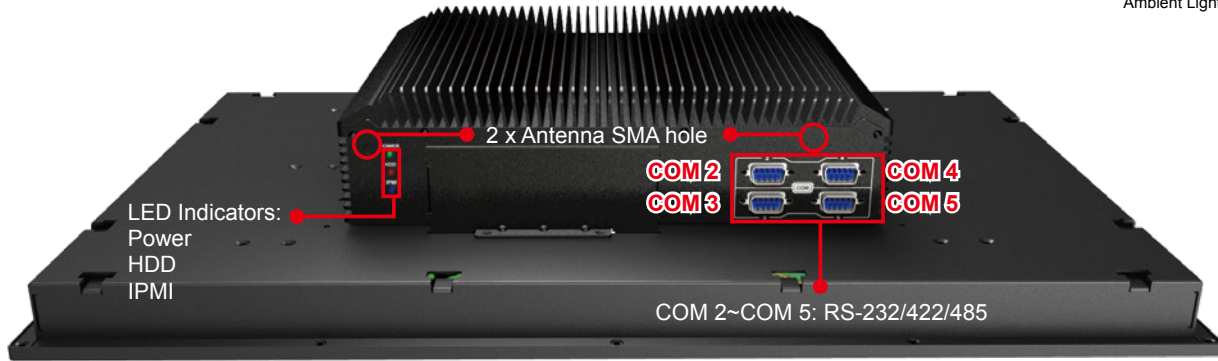

S19A-QM87 Dimensions

(Unit: mm)

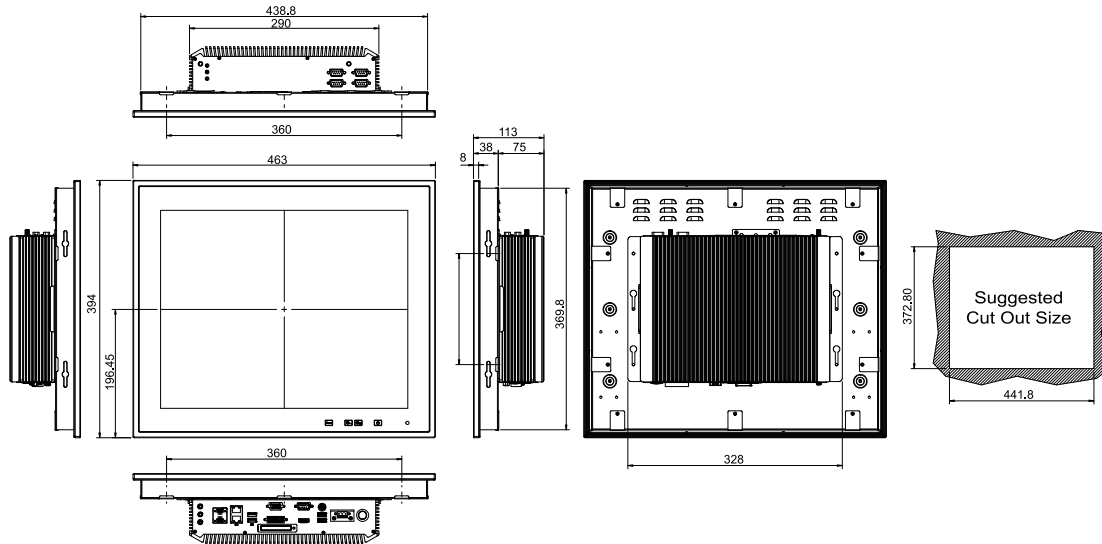

S24A-QM87 Dimensions

(Unit: mm)

