



Backplane
Systems
Technology

Backplane Systems
Technology Pty Ltd

TEL 02 9457 6400
sales@backplane.com.au
www.backplane.com.au

Proudly Australian-Owned Since 1989



Ever Expanding Edge AI Boundaries

Wide-temperature Fanless Embedded Systems



About Neosys Technology

Established in 2010, Neosys Technology designs and manufactures industrial grade rugged embedded computers and systems with core expertise ranging from embedded computing to data acquisition and processing.

Our dedication to innovate and integrate practical application-oriented functions set us apart from the rest and our products are ideal solutions for automation, machine vision, transportation, GPU computing, surveillance and video analytics.

Neosys Technology application-oriented systems thrive in the following fields:

- Wide temperature range fanless computer
- Rugged embedded industrial computing
- Machine vision controller
- In-vehicle fanless computer
- Ultra compact fanless embedded computer
- Surveillance/ video analytics computing
- GPU computing platform

Table of Contents



Rugged Embedded

Nuvo-9000E/ P/ LP/ DE P. 36

Intel® 13th/12th-Gen Core™ Rugged Embedded Computer with 6x 2.5GbE/ GbE, USB 3.2 Type-C, Patented Cassette & MeziO® Interface

Nuvo-9531 P. 40

Intel® 13th/12th -Gen Core™ i9/ i7/ i5/ i3 Compact Fanless Computer with 4x 2.5GbE, 4x USB3.2 and 1x Hot-swappable HDD Tray

Nuvo-9501 P. 42

Intel® 13th/12th-Gen Core™ Compact Fanless Computer with 2x 2.5GbE and 4x USB3.2

Nuvo-7000E/ P/ DE P. 44

Intel® 9th/ 8th-Gen Core™ i7/ i5/ i3 Fanless Controller with 6x GbE Ports, Patented Cassette and MeziO® Interface

Nuvo-7000LP P. 46

Intel® 9th/ 8th-Gen Core™ i7/ i5/ i3 Fanless Controller with 6x GbE Ports, MeziO® Interface and Low-profile Chassis

Nuvo-7501 P. 48

Intel® 9th/ 8th -Gen Core™ i7/ i5/ i3 Compact Fanless Computer with 2x GbE and up to 6x COM

Nuvo-7531 P. 50

Intel® 9th/ 8th -Gen Core™ i7/ i5/ i3 Compact Fanless Computer with 4x GbE, 4x USB3.1 and 1x hot-swappable HDD tray

Nuvo-5000E/ P P. 52

Intel® 6th-Gen Core™ i7/ i5/ i3 Fanless Controller with 6x GbE, Expansion Cassette and MeziO® Interface

Nuvo-5000LP P. 54

Intel® 6th-Gen Core™ i7/i5/i3 Fanless Controller with 6x GbE, MeziO® Interface and Low-profile Chassis

Nuvo-5026E P. 56

Intel® 6th-Gen Core™ i7/ i5/ i3 Fanless Controller with Dual PCIe Slot Expansion Cassette, 6x GbE and MeziO® Interface

Nuvo-5501 P. 58

Intel® 6th-Gen Core™ i7/ i5/ i3 Compact Fanless Embedded Controller with 3x GbE

Nuvo-2600 P. 60

Intel® Elkhart Lake Atom® x6425E Fanless Box-PC with 4x PoE+, 7/15mm 2.5" HDD and PCIe Expansion Cassette

Nuvo-8034 P. 62

Intel® 9th/ 8th-Gen Core™ i7/ i5/ i3 Rugged Embedded Computer with 7 PCIe/ PCI Expansion Slots

Nuvo-8000 P. 64

Intel® 9th/ 8th-Gen Core™ i7/ i5/ i3 Expansion Box-PC with up to 5 PCIe/ PCI Slots

Nuvo-8111 P. 66

Cost-effective AI Platform for Factory Automation Supporting NVIDIA® 200W GPU and Intel® 9th/ 8th-Gen Core™ Processor

Nuvo-6000 P. 68

Intel® 6th-Gen Core™ i7/ i5/ i3 Fanless Box-PC with Up to 5 PCIe/ PCI Expansion Slots

Nuvo-2700DS P. 70

AMD Ryzen™ V1000 Rugged 4x 4K Interactive Digital Signage System Supporting 2x Google Edge TPU

POC-700 P. 72

Intel® Core™ i3-N305 Ultra-Compact Embedded Controller with 4x PoE+, 4x USB 3.2 and MeziO® Interface

POC-500 P. 74

AMD Ryzen™ V1000 Ultra-compact Embedded Controller with 4x PoE+, 4x USB 3.1 and MeziO® Interface

POC-400 P. 76

Intel® Elkhart Lake Atom® x6425E Ultra-compact Fanless Embedded Computer with 2.5GbE & PoE+

POC-40 P. 78

Intel® Elkhart Lake Atom® x6211E Extreme-compact Embedded Computer

POC-300 P. 80

Intel® Apollo Lake Pentium® N4200 and Atom™ E3950 Ultra-compact DIN-rail Controller with GbE, PoE and USB 3.1

POC-465AWP P. 82

IP65 Waterproof Computer with Intel® Atom® x6425E, 2x 2.5GbE and Isolated COM Ports

PB-9250J-110V P. 86

9250 w-s Standalone Supercapacitor-based UPS Module with 110V DC Input for Railway Application

PB-9250J/ PB-4600J/ 2580J P. 88

Industrial-grade Standalone Intelligent Supercapacitor-based Uninterruptible Power Backup Module

PB-2500J P. 90

Industrial-Grade Intelligent Supercapacitor-based Power Backup Module



IoT Gateway

IGT-33V/ IGT-34C P. 92

T1 Sitara™ AM3352 ARM-based Industrial IoT Gateway with Analog Inputs and Pre-installed Debian

IGT-30D/ IGT-31D P. 94

T1 Sitara™ AM3352 ARM-based Industrial IoT Gateway with Dual LAN and Pre-installed Debian

IGT-20/ IGT-21/ IGT-22 P. 96

Industrial Grade ARM-based Smart Wireless IoT Gateway with ARM Cortex A8, Dual T-Flash (microSDHC), and Pre-installed Debian



Machine Vision

Nuvis-7306RT P. 100

Intel® 9th/ 8th-Gen Core™ i7/ i5 vision controller with vision-specific I/O, real-time controller and GPU-computing

Nuvis-5306RT P. 102

Intel® 6th-Gen Core™ i7/ i5 Vision Controller with Vision-Specific I/O, Real-time Control and GPU-computing

Nuvis-534RT P. 104

AMD Ryzen™ V1807B Ultra-compact Vision Controller with Vision-specific I/O and Real-time control

LTN-450..... P. 106

4-CH/ 2-CH Constant-current LED Controller Supporting 10A Overdriving

PCIe-PoE454..... P. 108

4-port 5GBASE-T Ethernet 802.3at PoE+ Frame Grabber Card

PCIe-PoE550X..... P. 109

2-port 10GbE Network Adapter with IEEE 802.3at PoE+

PCIe-PoE334LP P. 110

Low-profile 4-port Server-grade Gigabit PoE+ Card with 1 kV Surge Protection

PCIe-PoE354at/352at P. 111

4-Port / 2-Port Server-grade Gigabit 802.3at PoE+ Frame Grabber Card

PCIe-USB381F P. 112

8-Port USB 3.1 Gen1 Frame Grabber Card with 4x Independent USB Controllers



In-vehicle Computing

Nuvo-7200VTC P. 114

Intel® 9th/ 8th-Gen Core™ i7/i5/i3 In-vehicle Controller with 4x or 8x PoE+ Ports, Single-slot PCIe Cassette

Nuvo-7250VTC P. 116

Intel® 9th/ 8th-Gen Core™ i7/i5/i3 In-vehicle Controller with 4x or 8x PoE+ Ports, Supercapacitor-based Power Backup Module

Nuvo-7100VTC P. 118

Intel® 9th/ 8th-Gen Core™ i7/i5/i3 In-vehicle Controller with 4x or 8x PoE+ Ports, DIO, CAN bus and RAID

Nuvo-5100VTC P. 120

Intel® 6th-Gen Core™ i7/i5/i3 In-vehicle Controller with 4x or 8x PoE+ Ports, DIO, CAN bus and RAID

Nuvo-2610VTC P. 122

Intel® Elkhart Lake Atom® x6425E In-Vehicle Computer with 4x M12 PoE+ ports and 15mm 2.5" HDD/SSD support

Nuvo-2615RL P. 124

EN50155 & EN45545 Intel® Elkhart Lake Atom® x6425E Railway Computer Supporting 110 VDC Input and 4x M12 PoE+

POC-551VTC P. 126

AMD Ryzen™ V1605B Ultra-compact In-vehicle Controller with PoE+, DIO and Isolated CAN bus

POC-451VTC P. 128

Intel® Elkhart Lake Atom® x6425E Ultra-compact In-vehicle Computer with 3x 2.5G, PoE+ and M.2/mPCIe for WIFI/4G/5G Modules

POC-351VTC P. 130

Intel® Apollo Lake Atom™ E3950 Ultra-compact In-vehicle Controller with GbE, PoE+ and Isolated CAN bus

NRU-110V P. 132

NVIDIA® Jetson AGX Xavier™ Edge AI Platform Supporting 8x GMSL Automotive Cameras and 10GbE Ethernet

NRU-51V P. 134

Rugged NVIDIA® Jetson Xavier™ NX GMSL2 Camera Sensor Hub for Autonomous Vehicles and Teleoperation

PCIe-GL26 P. 136

AI-enabled 6-port GMSL2 Camera Frame Grabber Card

PCIe-NX154PoE P. 138

100 TOPS Intelligent Frame Grabber Card with 4x PoE+ ports for IVA or AI Inspection

PCIe-NX156U3 P. 139

100 TOPS Intelligent Frame Grabber Card with 6x USB 3.2 ports for AI Inspection

PCIe-PoE312M P. 140

4-port Server-grade Gigabit 802.3at PoE+ Card with M12 x-coded Connectors



Surveillance/ Video Analytics

NRU-220S P. 142

NVIDIA® Jetson AGX Orin™ AI NVR for Intelligent Video Analytics

NRU-120S P. 144

NVIDIA® Jetson AGX Xavier™ AI NVR for Intelligent Video Analytics

NRU-52S P. 146

Rugged NVIDIA® Jetson Xavier™ NX Edge AI Computer with 4x PoE++ Ports for Intelligent Video Analytics

Nuvo-5608VR P. 148

Intel® 6th-Gen Core™ i7/i5 Fanless Surveillance System with 8x PoE+, DIO, CAN bus and 2x 3.5" HDD Accommodation Supporting RAID 0/1

PCIe-PoE425bt P. 150

4-port 2.5GBASE-T Network Adapter with IEEE 802.3bt PoE++ Capability

Table of Contents



GPU Computing

RGS-8800GC P. 152
AMD® EPYC™ 7003 "MILAN" Series Rugged HPC Server Supporting NVIDIA® RTX A6000/ A4500, 2x 10G and 4x 1G Ethernet

Nuvo-10208GC P. 154
Industrial-grade Edge AI Platform Supporting Dual NVIDIA® RTX series 350W GPU Cards, Intel® 13th /12th-Gen Core™ Processor with 3x Additional PCIe Slots and 10G/2.5G/1G Ethernet Ports

Nuvo-8208GC P. 156
Industrial-grade GPU Computing Platform Supporting Dual 250W NVIDIA® Graphics Card, Intel® Xeon® E or 9th/ 8th-Gen Core™ Processor

Nuvo-8108GC-XL P. 158
Industrial-grade Edge AI Platform Supporting NVIDIA® RTX 30 series GPU Card, Intel® Xeon® E and 9th/ 8th-Gen Core™ Processor

Nuvo-8108GC-QD P. 160
Industrial-grade Edge AI Platform Supporting NVIDIA® RTX A6000/ A4500 GPU, Intel® Xeon® E and 9th/ 8th-Gen Core™ Processor

Nuvo-8108GC P. 162
Industrial-grade Edge AI Platform Supporting 250W NVIDIA® Graphics Card, Intel® Xeon® E or 9th/ 8th-Gen Core™ Processor

Nuvo-8240GC P. 164
Industrial-grade Edge AI Platform Supporting Dual NVIDIA® Tesla T4 and Intel® Xeon® E and 9th/ 8th-Gen Core™ Processor

Nuvo-6108GC/ Nuvo-6108GC-IGN P. 166
Industrial-grade In-vehicle GPU-computing Platform with 250W NVIDIA® GPU and Intel® Xeon® E3 v5 and 6th-Gen Core™ Processor

Nuvo-9160GC P. 168
Ruggedized AI Inference Platform supporting 130W NVIDIA® RTX GPU and Intel® 13th/ 12th-Gen Core™ Processor

Nuvo-7168GC P. 170
Ruggedized AI Inference Platform Supporting NVIDIA® RTX A2000 and Intel® 9th/ 8th-Gen Core™ Processor

Nuvo-7164GC/ 7166GC P. 172
Ruggedized AI Inference Platform Supporting NVIDIA® Tesla T4 and Intel® 9th/ 8th-Gen Core™ Processor

Nuvo-7160GC P. 174
Ruggedized GPU-computing Platform Supporting 120W NVIDIA® GPU and Intel® 9th/ 8th-Gen Core™ Processor

Nuvo-5095GC P. 176
Compact and Wide Temperature GPU-Computing Platform Supporting 75W NVIDIA® GPU and Intel® 6th-Gen Core™ Processor



SEMIL-1700GC P. 180
IP67 Waterproof GPU Computer supporting NVIDIA® Tesla T4/ Quadro P2200 and Intel® Xeon® E or 9th/ 8th-Gen Core™ CPU with All M12 Connectors

SEMIL-1700 P. 182
Half-rack IP67 Waterproof Computer Supporting Intel® Xeon® E or 9th/ 8th-Gen Core™ Processor with All M12 Connectors

SEMIL-1300GC P. 184
Wide-temperature Fanless GPU Computer supporting NVIDIA® Tesla T4/ Quadro P2200 GPU and Intel® Xeon® E or 9th/ 8th-Gen Core™ CPU with M12 connectors

SEMIL-1300 P. 186
Half-Rack Rugged Fanless Computer Supporting Intel® Xeon® E or 9th/ 8th-Gen Core™ Processor with M12 connectors

Neosys MeziO® Modules P. 190
Accessories P. 194

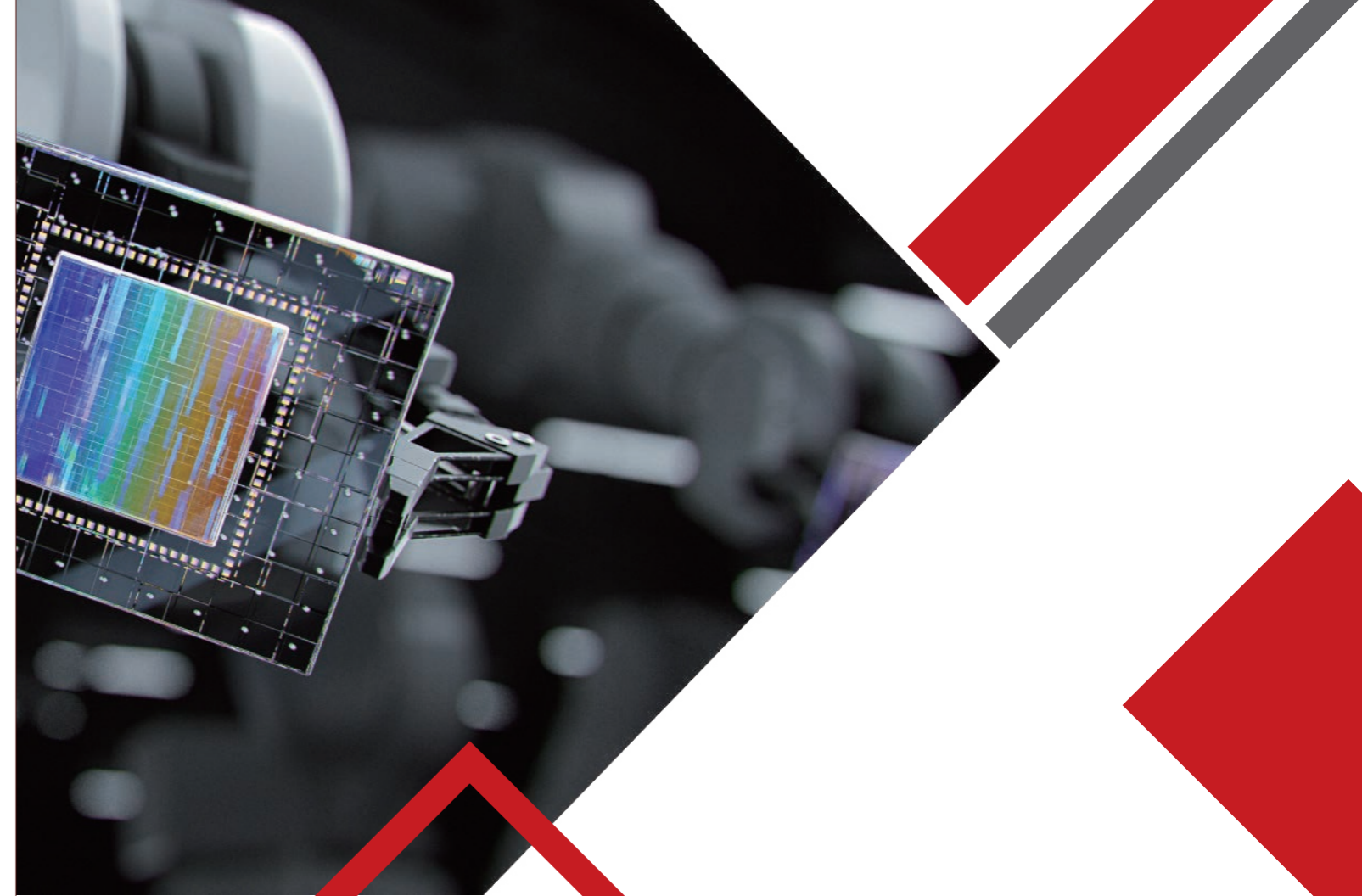

Product Highlight

Wide Temperature Fanless Embedded System

Neosys' exclusive mechanical design and thermal pad efficiently dissipate heat from CPU and other components. It allows Neosys products to operate under 100% CPU loading in a wide temperature environment ranging from -40°C to 70°C*.



*Available on selected systems

PCIe/PCI Expansion Cassette

(R.O.C Patent No. M456527)

Neosys' patented Cassette technology innovates a brilliant way for accommodating add-on cards. The modularized design is easy to install or replace and it offers passive cooling to the add-on card for reliable operation. Customers can install any PCI or PCIe card in the Cassette, or choose Neosys' selection of standard Cassette modules* with preinstalled heat-spreader for PoE+, USB 3.1 or independent graphics card.



Concept of Cassette

As the dedicated heat-spreader makes contact with components and the heat is conducted to the surface of the Cassette enclosure, it is able to sustain a stable internal thermal condition.

- Two enclosures, one dedicated for the system and the other dedicated for add-on cards, separate compartments to minimize electrical and thermal interference
- Reliable mechanical/ electrical connection between system and Cassette

*Available on selected systems

Industrial-grade GPU Computing Platform

Featuring patented Cassette technology and an innovative thermal ventilation design, Neosys GPU computing platforms support 75W~350W NVIDIA® GPUs. They are applicable to CUDA computing, autopilot, deep learning, virtual reality and also allow sustained full load operation under -25°C to 60°C* wide temperature conditions.



*Available on selected systems

IEEE 802.3at PoE+ Ports

Supplying up to 25.5W of power per port, Neosys systems* provide multiple IEEE 802.3at PoE+ ports for connecting PoE powered devices (PD) such as IP cameras, wireless access points for related applications such as machine vision, in-vehicle and surveillance. Neosys provides turnkey platforms that offer cost reductions when deploying embedded vision systems.



*Available on selected systems

Leading Edge Fanless Design

Neosys makes one of the most thermal efficient industrial embedded systems. Neosys thermal solution simplifies the heat conduction path to dissipate heat by placing extremely efficient thermal interface materials (thermal pads) on the CPU and electronic components, allowing them to directly make contact with the external heatsink. Neosys fanless embedded systems differ from others in a number of ways:

- **Heat-generating components are segregated.** The Neosys design team placed all heat-generating components on the top side.
- **Segregated and evenly distributed to avoid heat-soak.** The heat-generating components are evenly distributed along the top side of the PCB.
- **Neosys systems use a unique and extremely efficient premium-grade thermal pad.** Neosys fanless embedded systems place just a single layer of thermal pad directly between the heat-generating components and the external heatsink, heat conduction ability is direct and effective.
- **Unique mechanical and thermal design from the ground up.** By not using ready-made solutions, Neosys fanless embedded system is designed and tweaked for maximum thermal efficiency.

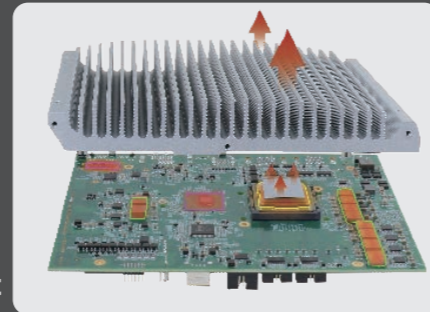

DTIO and NuMCU

(R.O.C Patent No. 1526834)

Neosys Deterministic Trigger I/O (DTIO) and NuMCU are a MCU-based architecture technology that provides a deterministic timing correlation between input and output signals. It utilizes a standalone microprocessor with highly optimized algorithm to collaborate with platform and DIO circuit. DTIO and NuMCU redefine machine vision systems* that require accurate interaction between light, camera, actuator and sensor devices.

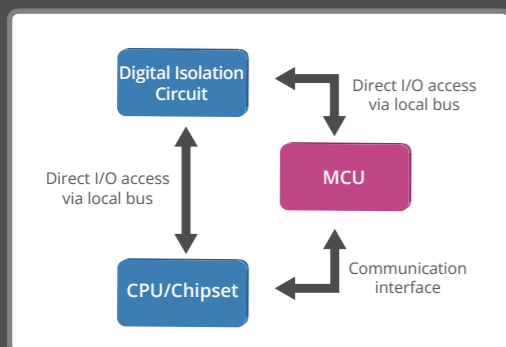

Hardware architecture of DTIO



Innovative approach to implement your own algorithm and create your own unique solution

*Available on selected systems

Patented and Effective Damping Solution

Neosys makes one of the most reliable rugged in-vehicle computers* and the secret is in the specially designed bracket that has been tested to withstand military-grade shock and vibration tests. The ability to counteract or absorb vibration and shock is essential to ensure in-vehicle computer operations. With each damping bracket designed specifically for a particular system, the specificity of the system's effective mass and dimensions have been carefully calculated and planned for.

In addition to the system damping bracket, the GPU-aided systems* also receive Neosys designed adjustable graphics brackets to hold graphics cards in place. This further ensures the inference accelerated system is always operating at optimum performance while retaining stability and ruggedness for various in-vehicle applications.

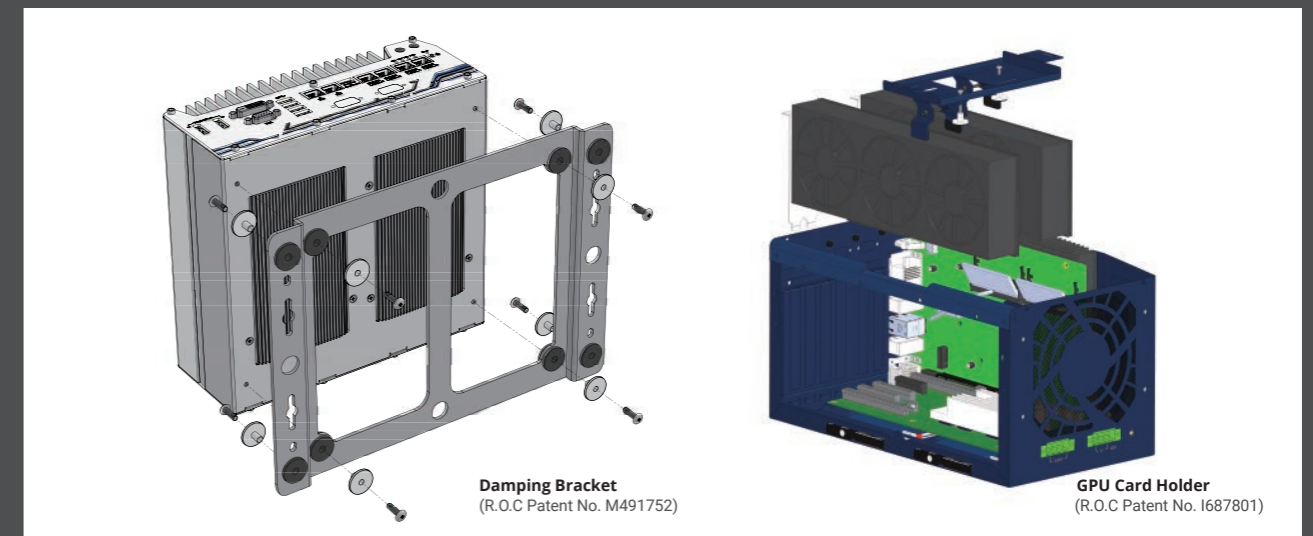

*Available on selected systems

MezIO® Module

MezIO® is the interface designed for incorporating application-oriented I/O functions into an embedded system. It offers computer signals, power rails and control signals via a high-speed connector. MezIO® module benefits from its 3-point mounted mezzanine structure for mechanical stability.

Neosys MezIO® modules* offer a variety of I/Os such as RS-232/422/485, isolated DIO, CAN bus, ignition power control and DTIO. Users can also leverage signals/ power on MezIO® interface to create a module with specific domain know-how. The Neosys MezIO® module presents a cost-effective way to build a tailor-made embedded system for your application.

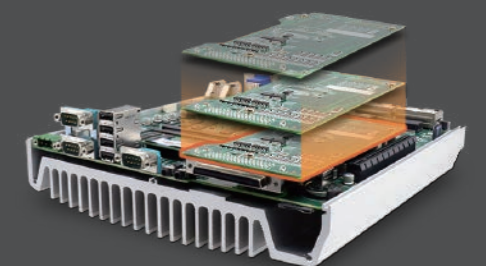

Concept of MezIO® Interface

Neosys MezIO® (interchangeable mezzanine I/O board) is the interface module designed for incorporating application-oriented I/O functions into an embedded system.

High Speed Board to Board Connector

MezIO® module offers various signals and power rails via a high-speed connector for high-density and high-power applications.

*Available on selected systems

IP67 Waterproof 2U 19" Chassis

(R.O.C Patent No. I697759)

Neosys SEMIL utilizes a customized o-ring and combines that with a stainless steel monoblock as the main chassis. There is a small service door opening at the bottom of the monoblock enclosure for maintenance purposes. The opening is concealed with stainless steel screws tightened in specific order and torque to ensure IP67 waterproof rating while retaining serviceability.



SuperCAP Power Backup Module

(R.O.C Patent No. I598820)

Neosys has patented an architecture that incorporates a microprocessor along with supercapacitor and charge/discharge controller. It provides sophisticated features such as real-time energy monitoring, high/low voltage protection and auto/manual shutdown control. Users can also extend the lifespan of ultracapacitors up to 4.8x via the parameter configuration utility. It has a wide operating temperature range (-40°C-85°C) and an exceptionally long operating life of 10 years or 500,000 charge-discharge cycles. These two traits help make it a reliable industrial power backup solution.



Neosys Technology GMSL2 Camera Platform

A GMSL2 camera turnkey solution including cameras, drivers, and an embedded computer

The GMSL2 automotive camera can provide high-quality images with minimal latency. It plays a critical role for perception in autonomous vehicles, teleoperation, AMR controllers, and vision-based scenarios requiring constant interaction with surroundings. Also, it has advanced features that benefit on-road and off-highway applications, such as IP67 waterproof, high dynamic range (>120dB HDR), auto white balance (AWB), and LED flicker mitigation (LFM). Not to mention the ease of deployment by a single coaxial cable for a camera, up to 15 meters.

As for applications that require dynamic illumination and short response time, the GMSL2 automotive camera outperforms the industrial GigE and IP cameras. Unlike industrial GigE cameras that are designed for fixed lighting conditions and high-speed inspections, the GMSL2 automotive cameras are intended for outdoor usage that adapts to dynamic lighting conditions within one or two frames. Both the IP cameras and the GMSL2 automotive cameras offer high dynamic range images, but the former requires extra processing time due to video encoding. On the other hand, the GMSL2 automotive cameras can output three-exposure HDR images with much shorter latency.

Although the GMSL2 automotive camera has many benefits, very limited ready-to-use solutions are available. Neosys' GMSL2 camera platform is a turnkey solution, it includes selected cameras, pre-built drivers, and an embedded computer. You can either use it as a robotic controller, an ADAS unit, or you can use it as a GMSL2 camera frame grabber to provide real-time video streaming to another powerful GPU computer.

Ruggedized Edge AI Platform Supporting 4x GMSL2 Cameras

— Powered by NVIDIA® Jetson Xavier™ NX



15W Edge AI



Support
GMSL2 Camera



10G Ethernet



NRU-51V



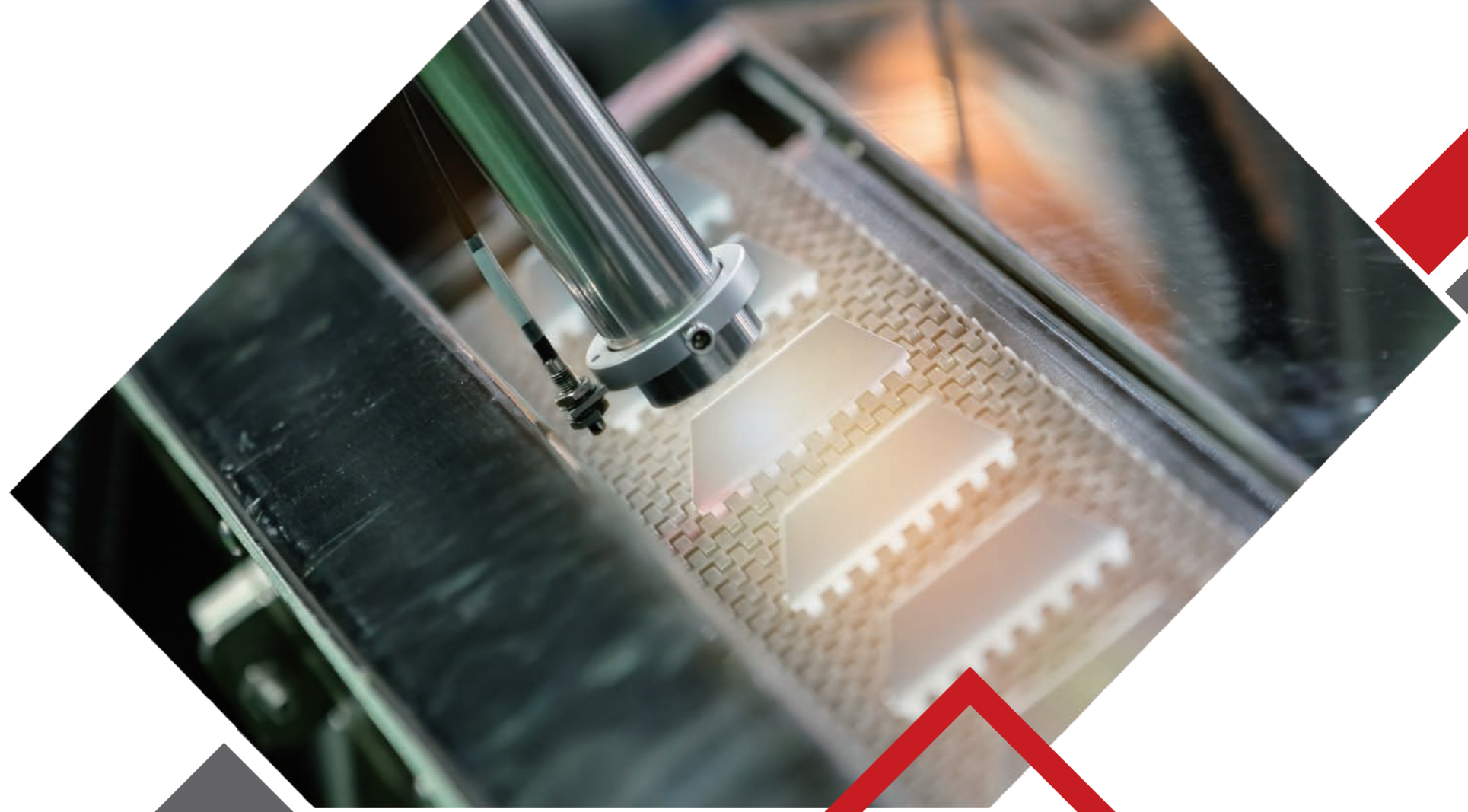

Product
Selection Guide

Selection Guide

■ Rugged Embedded ■ Machine Vision ■ In-vehicle Computing ■ Surveillance/Video Analytics ■ GPU Computing ■ IoT Gateway

New!

New!

New!

New!



Model Name	Nuvo-9000E/ P/ DE	Nuvo-9000LP	Nuvo-9531	Nuvo-9501
Dimensions (W x D x H)	240 x 225 x 90 mm (Nuvo-9000E/ P) 240 x 225 x 110.5 mm (Nuvo-9000DE)	240 x 225 x 79 mm	212x 165 x 63 mm	212 x 165 x 80 mm
Weight	3.58 kg (Nuvo-9000E/P) 3.89 (Nuvo-9000DE)	3.36 kg	2.5 kg	2.5 kg
Chassis Construction	Aluminum alloy with heavy duty metal	Aluminum alloy with heavy duty metal	Aluminum alloy with heavy duty metal	Aluminum alloy with heavy duty metal
Processor	- Intel® Core™ i9-13900E/ i9-13900TE i9-12900E/ i9-12900TE - Intel® Core™ i7-13700E/ i7-13700TE i7-12700E/ i7-12700TE - Intel® Core™ i5-13500E/ i5-13400E/ i5-13500TE - Intel® Core™ i5-12500E/ i5-12500TE i3-13100E/ i3-13100TE i3-12100E/ i3-12100TE - Intel® Pentium® G7400E/ G7400TE - Intel® Celeron® G6900E/ G6900TE	- Intel® Core™ i9-13900E/ i9-13900TE i9-12900E/ i9-12900TE - Intel® Core™ i7-13700E/ i7-13700TE i7-12700E/ i7-12700TE - Intel® Core™ i5-13500E/ i5-13400E/ i5-13500TE - Intel® Core™ i5-12500E/ i5-12500TE i3-13100E/ i3-13100TE i3-12100E/ i3-12100TE - Intel® Pentium® G7400E/ G7400TE - Intel® Celeron® G6900E/ G6900TE	- Intel® Core™ i9-13900E/ i9-13900TE i9-12900E/ i9-12900TE - Intel® Core™ i7-13700E/ i7-13700TE i7-12700E/ i7-12700TE - Intel® Core™ i5-13500E/ i5-13400E/ i5-13500TE - Intel® Core™ i5-12500E/ i5-12500TE i3-13100E/ i3-13100TE i3-12100E/ i3-12100TE - Intel® Pentium® G7400E/ G7400TE - Intel® Celeron® G6900E/ G6900TE	- Intel® Core™ i9-13900E/ i9-13900TE i9-12900E/ i9-12900TE - Intel® Core™ i7-13700E/ i7-13700TE i7-12700E/ i7-12700TE - Intel® Core™ i5-13500E/ i5-13400E/ i5-13500TE - Intel® Core™ i5-12500E/ i5-12500TE i3-13100E/ i3-13100TE i3-12100E/ i3-12100TE - Intel® Pentium® G7400E/ G7400TE - Intel® Celeron® G6900E/ G6900TE
Chipset	Intel® Q670E	Intel® Q670E	Intel® H610E	Intel® H610E
Graphics	Intel® UHD Graphics 770/ 730	Intel® UHD Graphics 770/ 730	Intel® UHD Graphics 770/ 730	Intel® UHD Graphics 770/ 730
Memory	Up to 64 GB DDR5 4800	Up to 64 GB DDR5 4800	Up to 32 GB DDR4 3200	Up to 32 GB DDR4 3200
PoE	Optional (Port 3 to 6, IEEE 802.3at, 25.5W)	Optional (Port 3 to 6, IEEE 802.3at, 25.5W)	Optional (Port 1 to 4, IEEE 802.3at, 25.5W)	-
Ethernet	1x 2.5GbE (I225) and 1x GbE (I219) (Nuvo-9002E/ P/ DE) 5x 2.5GbE (I225) and 1x GbE (I219) (Nuvo-9006E/ P/ DE)	1x 2.5GbE (I225) and 1x GbE (I219) (Nuvo-9002LP) 5x 2.5GbE (I225) and 1x GbE (I219) (Nuvo-9006LP)	4x 2.5GbE by Intel® I226-IT	2x 2.5GbE by Intel® I226-V (Nuvo-9501) 2x 2.5GbE by Intel® I226-IT (Nuvo-9505D)
Video Port	1x VGA 1x DVI-D 1x DisplayPort	1x VGA 1x DVI-D 1x DisplayPort	1x VGA 1x DisplayPort	1x VGA 1x DisplayPort
Serial Port	2x RS-232/422/485 2x RS-232	2x RS-232/422/485 2x RS-232	1x RS-232/422/485 3x 3-wire RS-232 or 1x RS-422/485	1x RS-232/422/485 3x 3-wire RS-232 or 1x RS-422/485
USB 2.0	2	2	2	2
USB 3.2/ USB 3.1	7 (incl. 1x 20Gbps type-C)	7 (incl. 1x 20Gbps type-C)	4	4
Audio	1x mic-in and speaker-out	1x mic-in and speaker-out	1x mic-in and speaker-out	1x mic-in and speaker-out
Digital I/O	Optional via MeziO® module	Optional via MeziO® module	4DI +4DO	4DI +4DO (Nuvo-9505D only)
SATA HDD	2x 2.5" HDD/ SSD	1x hot-swap tray for 2.5" HDD/ SSD	1x hot-swap tray for 2.5" HDD/ SSD	1x 2.5" HDD/ SSD or 1x 3.5" HDD
mSATA	-	-	-	-
M.2 (M-key)	1 (Gen4 x4)	1 (Gen4 x4)	1 (Gen4 x4)	1 (Gen4 x4)
M.2 (B-key/E-key)	1x M.2 B-key	1x M.2 B-key	1x M.2 E-key	1x M.2 E-key
SIM	2	2	2	2
MeziO®	Yes	Yes	-	-
PCI/PCI Express	1x PCIe x16 slot @ Gen3, 8-lanes PCIe signals in Cassette (Nuvo-9000E) 1x PCI slot in Cassette (Nuvo-9000P) 2x PCIe x16 slots @ Gen3, 8-lanes PCIe signals in Cassette (Nuvo-9000DE)	-	-	-
DC Input	8 to 48V DC	8 to 48V DC	8 to 48V DC	8 to 35V DC
Ignition Control	Optional via MeziO® module	Optional via MeziO® module	-	-
Operating Temperature	with 35W CPU -25°C ~ 70°C with 65W CPU -25°C ~ 50°C	with 35W CPU -25°C ~ 70°C with 65W CPU -25°C ~ 50°C	-25°C ~ 60°C	-10°C ~ 60°C (Nuvo-9501) -25°C ~ 60°C (Nuvo-9505D)
Certification	CE/ FCC	CE/ FCC	CE/ FCC	CE/ FCC
Released Date	2022/ 12	2022/ 12	2023/ 1	2023/1
Page Number	P. 36 - 39	P. 36 - 39	P. 40 - 41	P. 42 - 43

■ Rugged Embedded ■ Machine Vision ■ In-vehicle Computing ■ Surveillance/Video Analytics ■ GPU Computing ■ IoT Gateway



Model Name	Nuvo-7000E/P/DE	Nuvo-7000LP	Nuvo-7531	Nuvo-7501
Dimensions (W x D x H)	240 x 225 x 90 mm (Nuvo-7000E/ P) 240 x 225 x 110.5 mm (Nuvo-7000DE)	240 x 225 x 79 mm	212 x 165 x 63 mm	212 x 173 x 76 mm
Weight	3.6 kg (Nuvo-7000E/P) 3.7 kg (Nuvo-7000DE)	3.1 kg	2.5 kg	2.7 kg
Chassis Construction	Aluminum alloy with heavy duty metal	Aluminum alloy with heavy duty metal	Aluminum alloy with heavy duty metal	Aluminum alloy with heavy duty metal
Processor	Intel® Core™ i7-9700E/ i7-9700TE/ i7-8700/ i7-8700T Intel® Core™ i5-9500E/ i5-9500TE/ i5-8500/ i5-8500T Intel® Core™ i3-9100E/ i3-9100TE/ i3-8100/ i3-8100T Intel® Pentium® G5400/ G5400T Intel® Celeron® G4900/ G4900T	Intel® Core™ i7-9700E/ i7-9700TE/ i7-8700/ i7-8700T Intel® Core™ i5-9500E/ i5-9500TE/ i5-8500/ i5-8500T Intel® Core™ i3-9100E/ i3-9100TE/ i3-8100/ i3-8100T Intel® Pentium® G5400/ G5400T Intel® Celeron® G4900/ G4900T	Intel® Core™ i7-9700E/ i7-9700TE/ i7-8700/ i7-8700T Intel® Core™ i5-9500E/ i5-9500TE/ i5-8500/ i5-8500T Intel® Core™ i3-9100E/ i3-9100TE/ i3-8100/ i3-8100T	Intel® Core™ i7-9700E/ i7-9700TE/ i7-8700/ i7-8700T Intel® Core™ i5-9500E/ i5-9500TE/ i5-8500/ i5-8500T Intel® Core™ i3-9100E/ i3-9100TE/ i3-8100/ i3-8100T
Chipset	Intel® Q370	Intel® Q370	Intel® H310	Intel® H310
Graphics	Intel® UHD Graphics 630	Intel® UHD Graphics 630	Intel® UHD Graphics 630	Intel® UHD Graphics 630
Memory	Up to 64 GB DDR4-2666/ 2400	Up to 64 GB DDR4-2666/ 2400	Up to 32 GB DDR4-2666/ 2400	Up to 32 GB DDR4-2666/ 2400
PoE	Optional (Port 3 to 6, IEEE 802.3at, 25.5W)	Optional (Port 3 to 6, IEEE 802.3at, 25.5W)	-	-
Ethernet	2x GbE by Intel® I219 and I210 (Nuvo-7002E/ P/ DE) 6x GbE by Intel® I219 and I210 (Nuvo-7006E/ P/ DE)	2x GbE by Intel® I219 and I210 (Nuvo-7002LP) 6x GbE by Intel® I219 and I210 (Nuvo-7006LP)	4x GbE by Intel® I219 and I210	2x GbE by Intel® I219 and I210
Video Port	1x VGA 1x DVI-D 1x DisplayPort	1x VGA 1x DVI-D 1x DisplayPort	1x DVI-I 1x DisplayPort	1x VGA 1x DVI-D
Serial Port	2x RS-232/422/485 2x RS-232	2x RS-232/422/485 2x RS-232	2x RS-232/422/485 (COM1/ COM2)	2x RS-232/422/485 (Nuvo-7501) 2x RS-232 (Nuvo-7501) 2x isolate RS-232/422/485 (Nuvo-7505D) 2x isolate RS-232 (Nuvo-7505D) 2x RS-232 (Nuvo-7505D)
USB 2.0	1 (internal)	1 (internal)	2	1 (internal)
USB 3.2/ USB 3.1	8	8	4	4
Audio	1x mic-in and speaker-out	1x mic-in and speaker-out	1x mic-in and speaker-out	1x mic-in and speaker-out
Digital I/O	Optional via MeziO® module	Optional via MeziO® module	4 DI + 4 DO	8 DI + 8 DO (Nuvo-7505D)
SATA HDD	2x 2.5" HDD/ SSD	1x 2.5" HDD/ SSD 1x hot-swap tray for 2.5" HDD/ SSD	1x hot-swap tray for 2.5" HDD/ SSD	1x 2.5" HDD/ SSD or 1x 3.5" HDD
mSATA	1 (mux. with mini-PCIe)	1 (mux. with mini-PCIe)	-	-
M.2 (M-key)	1	1	1	1
M.2 (B-key/E-key)	1x M.2 B-key	1x M.2 B-key	-	1x M.2 B-key
SIM	3	3	3	1
MeziO®	Yes	Yes	-	-
PCI/PCI Express	1x PCIe x16 slot @ Gen3, 8-lanes PCIe signals in Cassette (Nuvo-7000E) 1x PCI slot in Cassette (Nuvo-7000P) 2x PCIe x16 slots @ Gen3, 8-lanes PCIe signals in Cassette (Nuvo-7000DE)	-	-	-
DC Input	8 to 35V DC	8 to 35V DC	8 to 35V DC	8 to 35V DC
Ignition Control	Optional via MeziO® module	Optional via MeziO® module	Optional	-
Operating Temperature	with 35W CPU -25°C ~ 70°C with 65W CPU -25°C ~ 50°C	with 35W CPU -25°C ~ 70°C with 65W CPU -25°C ~ 50°C	-25°C ~ 60°C	-25°C ~ 60°C
Certification	CE/ FCC, UL62368-1	CE/ FCC	CE/ FCC	CE/ FCC
Released Date	2018/ 6	2018/ 6	2020/ 5	2020/ 5
Page Number	P. 44 - 45	P. 46 - 47	P. 50 - 51	P. 48 - 49

Selection Guide

■ Rugged Embedded ■ Machine Vision ■ In-vehicle Computing ■ Surveillance/Video Analytics ■ GPU Computing ■ IoT Gateway



Model Name	Nuvo-5000E/ P	Nuvo-5000LP	Nuvo-5026E	Nuvo-5501	
Chassis	Dimensions (W x D x H)	240 x 225 x 90 mm	240 x 225 x 77 mm	240 x 225 x 111 mm	
	Weight	3.6 kg	3.1 kg	3.7 kg	
	Chassis Construction	Aluminum alloy with heavy duty metal	Aluminum alloy with heavy duty metal	Aluminum alloy with heavy duty metal	Aluminum alloy with heavy duty metal
System	Processor	Intel® Core™ i7-6700/ 6700TE Intel® Core™ i5-6500/ 6500TE Intel® Core™ i3-6100/ 6100TE Intel® Pentium® G4400/ G4400TE Intel® Celeron® G3900/ G3900TE	Intel® Core™ i7-6700/ 6700TE Intel® Core™ i5-6500/ 6500TE Intel® Core™ i3-6100/ 6100TE Intel® Pentium® G4400/ G4400TE Intel® Celeron® G3900/ G3900TE	Intel® Core™ i7-6700/ 6700TE Intel® Core™ i5-6500/ 6500TE Intel® Core™ i3-6100/ 6100TE Intel® Pentium® G4400/ G4400TE Intel® Celeron® G3900/ G3900TE	Intel® Core™ i7-6700TE Intel® Core™ i5-6500TE Intel® Core™ i3-6100TE Intel® Pentium® G4400TE Intel® Celeron® G3900TE
	Chipset	Intel® Q170	Intel® Q170	Intel® Q170	Intel® H110
	Graphics	Intel® HD Graphics 530/ 510	Intel® HD Graphics 530/ 510	Intel® HD Graphics 530/ 510	Intel® HD Graphics 530/ 510
	Memory	Up to 32 GB DDR4-2133	Up to 32 GB DDR4-2133	Up to 32 GB DDR4-2133	Up to 16 GB DDR4-2133
	PoE	Optional (Port 3 to 6, IEEE 802.3at, 25.5W)	Optional (Port 3 to 6, IEEE 802.3at, 25.5W)	Optional (Port 3 to 6, IEEE 802.3at, 25.5W)	-
I/O Interface	Ethernet	2x GbE by Intel® I219 and I210 (Nuvo-5002E/ P) 6x GbE by Intel® I219 and I210 (Nuvo-5006E/ P)	2x GbE by Intel® I219 and I210 (Nuvo-5002LP) 6x GbE by Intel® I219 and I210 (Nuvo-5006LP)	6x GbE by Intel® I219 and I210	3x GbE by Intel® I219 and I210
	Video Port	1x VGA 1x DVI-D 2x DisplayPort	1x VGA 1x DVI-D 2x DisplayPort	1x VGA 1x DVI-D 2x DisplayPort	1x VGA 1x DVI-D
	Serial Port	2x RS-232/422/485 1x RS-232	2x RS-232/422/485 1x RS-232	2x RS-232/422/485 1x RS-232	2x RS-232/422/485 2x RS-232
	USB 2.0	4	4	4	2
	USB 3.2/ USB 3.1	4	4	4	4
	Audio	1x mic-in and speaker-out	1x mic-in and speaker-out	1x mic-in and speaker-out	-
	Digital I/O	Optional via MezIO® module	Optional via MezIO® module	Optional via MezIO® module	Optional 8 DI + 8 DO
	Storage Interface	SATA HDD 2x 2.5" HDD/ SSD	SATA HDD/ SSD 1x 2.5" HDD/ SSD 1x hot-swap tray for 2.5" HDD/ SSD	SATA HDD/ SSD 2x 2.5" HDD/ SSD	SATA HDD/ SSD 1x 2.5" HDD/ SSD or 1x 3.5" HDD
Expansion Bus	mSATA	1 (mux. with mini-PCIe)	1 (mux. with mini-PCIe)	1 (mux. with mini-PCIe)	1
	M.2 (M-key)	-	-	-	-
	Mini PCI-E	2	2	2	1
	M.2 (B-key/E-key)	-	-	-	1x M.2 B-key
	SIM	2	2	2	1
Power Supply	DC Input	8 to 35V DC	8 to 35V DC	8 to 35V DC	8 to 35V DC
	Ignition Control	Optional via MezIO® module	Optional via MezIO® module	Optional via MezIO® module	-
	Environmental	Operating Temperature with 35W CPU -25°C ~ 70°C with 65W/ 51W CPU -25°C ~ 50°C	Operating Temperature with 35W CPU -25°C ~ 70°C with 65W/ 51W CPU -25°C ~ 50°C	Operating Temperature with 35W CPU -25°C ~ 70°C with 65W/ 51W CPU -25°C ~ 50°C	Operating Temperature -25°C ~ 70°C
Certification	CE/ FCC	CE/ FCC	CE/ FCC	CE/ FCC	
Released Date	2015/ 12	2015/ 12	2017/ 12	2017/ 11	
Page Number	P. 52 - 53	P. 54 - 55	P. 56 - 57	P. 58 - 59	

■ Rugged Embedded ■ Machine Vision ■ In-vehicle Computing ■ Surveillance/Video Analytics ■ GPU Computing ■ IoT Gateway

New!



Model Name	Nuvo-2600	Nuvo-2700DS	Nuvo-8034	Nuvo-8111	
Chassis	Dimensions (W x D x H)	205 x 155 x 86 mm	173 x 174 x 50mm	259 x 280 x 198 mm	
	Weight	2.3 kg (Nuvo-2600E) 2.5 kg (Nuvo-2600J)	1.6 kg	7 kg	4.5 kg
	Chassis Construction	Aluminum alloy with heavy duty metal	Aluminum alloy with heavy duty metal	Aluminum alloy with heavy duty metal	Aluminum alloy with heavy duty metal
System	Processor	Intel® Elkhart Lake Atom® x6425E	AMD Ryzen™ Embedded V1605B CPU	Intel® Xeon® E-2176G/ E-2124G/ E-2278GE/ E-2278GEL Intel® Core™ i7-9700E/ i7-9700TE/ i7-8700/ i7-8700T Intel® Core™ i5-9500E/ i5-9500TE/ i5-8500/ i5-8500T Intel® Core™ i3-9100E/ i3-9100TE/ i3-8100/ i3-8100T	Intel® Core™ i7-9700TE/ i7-8700/ i7-8700T Intel® Core™ i5-9500TE/ i5-8500/ i5-8500T Intel® Core™ i3-9100TE/ i3-8100/ i3-8100T Intel® Pentium® G5400T Intel® Celeron® G4900T
	Chipset	-	-	Intel® C246	Intel® H310
	Graphics	Intel® UHD Graphics	Vega GPU with 8 compute units	Intel® HD Graphics 630, or x16 PEG port	Intel® HD Graphics 630, or x16 PEG port
	Memory	Up to 32 GB DDR4-3200	Up to 64 GB DDR4-2400	Up to 128 GB DDR4-2133	Up to 32 GB DDR4-2666
	PoE	IEEE 802.3at (25.5W) for 4GbE Ports	-	-	-
I/O Interface	Ethernet	4x GbE by Intel® I210	2x GbE by Intel® I210	1x GbE by Intel® I219 1x GbE by Intel® I210	1x GbE by Intel® I219 1x GbE by Intel® I210*
	Video Port	1x DVI-I	4x DisplayPort	1x VGA 1x DVI-D 1x DisplayPort	2x DVI-D
	Serial Port	1x isolated RS-485 3x 3-wire RS-232 or 1x RS-422/485	2x RS-232 (COM1 in DB9, COM2 in RJ50)	2x RS-232/422/485 2x RS-232 (optional)	1x RS-232/422/485 1x RS-422/485 3x 3-wire RS-232
	USB 2.0	2+1 (internal)	2	1 (internal)	3 (internal)
	USB 3.2/ USB 3.1	1	2	8	4
	Audio	1x mic-in and speaker-out	1x mic-in and line-out	1x mic-in and speaker-out	1x mic-in and speaker-out
	Digital I/O	4 DI + 4 DO	Optional 4 DI + 4 DO	8 DI + 8 DO	-
	Storage Interface	SATA HDD 1x front-accessible HDD tray for 2.5" HDD/ SSD	-	SATA HDD/ SSD 2x hot-swap tray for 2.5" HDD/ SSD	SATA HDD/ SSD 2x 2.5" HDD/ SSD
Expansion Bus	mSATA	-	-	2 (mux. with mini-PCIe)	1 (SATA + USB 2.0 + USIM)
	M.2 (M-key)	1	1	1	-
	Mini PCI-E	2	2	2	-
	M.2 (B-key/E-key)	1x M.2 B-key	1x M.2 B-key 1x M.2 E-key	1x M.2 B-key	-
	SIM	2	1	4	1
Power Supply	DC Input	8 to 35V DC	8 to 35V DC	8 to 35V DC	24V DC
	Ignition Control	Optional	Built-in	-	-
	Environmental	Operating Temperature -25°C ~ 70°C	Operating Temperature -25°C ~ 70°C	Operating Temperature -25°C ~ 60°C	Operating Temperature -25°C ~ 60°C
Certification	CE/ FCC	CE/ FCC	CE/ FCC	CE/ FCC	
Released Date	2022/ 9	2021/ 2	2020/ 2	2022/ 1	
Page Number	P. 60 - 61	P. 70 - 71	P. 62 - 63	P. 66 - 67	

■ Rugged Embedded ■ Machine Vision ■ In-vehicle Computing ■ Surveillance/Video Analytics ■ GPU Computing ■ IoT Gateway



Model Name	Nuvo-8003	Nuvo-8023	Nuvo-8032	Nuvo-8041
Chassis				
Dimensions (W x D x H)	154 x 235 x 174 mm	185 x 235x 174 mm	185 x 235x 174 mm	185 x 235 x 174 mm
Weight	3 kg	3.6 kg	3.6 kg	3.6 kg
Chassis Construction	Aluminum alloy with heavy duty metal	Aluminum alloy with heavy duty metal	Aluminum alloy with heavy duty metal	Aluminum alloy with heavy duty metal
System				
Processor	Intel® Core™ i7-9700TE/ i7-8700/ i7-8700T Intel® Core™ i5-9500TE/ i5-8500/ i5-8500T Intel® Core™ i3-9100TE/ i3-8100/ i3-8100T Intel® Pentium® G5400T Intel® Celeron® G4900T	Intel® Core™ i7-9700TE/ i7-8700/ i7-8700T Intel® Core™ i5-9500TE/ i5-8500/ i5-8500T Intel® Core™ i3-9100TE/ i3-8100/ i3-8100T Intel® Pentium® G5400T Intel® Celeron® G4900T	Intel® Core™ i7-9700TE/ i7-8700/ i7-8700T Intel® Core™ i5-9500TE/ i5-8500/ i5-8500T Intel® Core™ i3-9100TE/ i3-8100/ i3-8100T Intel® Pentium® G5400T Intel® Celeron® G4900T	Intel® Core™ i7-9700TE/ i7-8700/ i7-8700T Intel® Core™ i5-9500TE/ i5-8500/ i5-8500T Intel® Core™ i3-9100TE/ i3-8100/ i3-8100T Intel® Pentium® G5400T Intel® Celeron® G4900T
Chipset	Intel® H310	Intel® H310	Intel® H310	Intel® H310
Graphics	Intel® HD Graphics 630, or x16 PEG port	Intel® HD Graphics 630, or x16 PEG port	Intel® HD Graphics 630, or x16 PEG port	Intel® HD Graphics 630, or x16 PEG port
Memory	Up to 32 GB DDR4-2666	Up to 32 GB DDR4-2666	Up to 32 GB DDR4-2666	Up to 32 GB DDR4-2666
I/O Interface				
PoE	-	-	-	-
Ethernet	1x GbE by Intel® I219 1x GbE by Intel® I210*	1x GbE by Intel® I219 1x GbE by Intel® I210	1x GbE by Intel® I219 1x GbE by Intel® I210	1x GbE by Intel® I219 1x GbE by Intel® I210
Video Port	2x DVI-D	2x DVI-D	2x DVI-D	2x DVI-D
Serial Port	1x RS-232/422/485 1x RS-422/485 3x 3-wire RS-232	1x RS-232/422/485 1x RS-422/485 3x 3-wire RS-232	1x RS-232/422/485 1x RS-422/485 3x 3-wire RS-232	1x RS-232/422/485 1x RS-422/485 3x 3-wire RS-232
USB 2.0	3 (internal)	3 (internal)	3 (internal)	3 (internal)
USB 3.2/ USB 3.1	4	4	4	4
Audio	1x mic-in and speaker-out	1x mic-in and speaker-out	1x mic-in and speaker-out	1x mic-in and speaker-out
Digital I/O	-	-	-	-
Storage Interface				
SATA HDD	2x 2.5" HDD/ SSD	2x 2.5" HDD/ SSD	2x 2.5" HDD/ SSD	2x 2.5" HDD/ SSD
mSATA	1 (SATA + USB 2.0 + USIM)	1 (SATA + USB 2.0 + USIM)	1 (SATA + USB 2.0 + USIM)	1 (SATA + USB 2.0 + USIM)
M.2 (M-key)	1	1	1	1
Mini PCI-E	-	-	-	-
M.2 (B-key/E-key)	-	-	-	-
SIM	1	1	1	1
MezIO®	-	-	-	-
PCI/PCI Express	1x PCIe x16 slot @ Gen3, 16-lanes 1x PCIe x8 slot @ Gen2, 4-lanes 1x PCIe x4 slot @ Gen2, 1-lane	1x PCIe x16 slot @ Gen3, 16-lanes 1x PCIe x4 slot @ Gen2, 2-lanes 1x PCIe x4 slot @ Gen2, 1-lane 2x 33MHz/ 32-bit 5VPCI slots	1x PCIe x16 slot @ Gen3, 16-lanes 1x PCIe x8 slot @ Gen2, 4-lanes 3x 33MHz/ 32-bit 5VPCI slots	1x PCIe x16 slot @ Gen3, 16-lanes 4x 33MHz/ 32-bit 5VPCI slots
Power Supply				
DC Input	8 to 35V DC	8 to 35V DC	8 to 35V DC	8 to 35V DC
Ignition Control	-	-	-	-
Environmental				
Operating Temperature	-25°C ~ 60°C	-25°C ~ 60°C	-25°C ~ 60°C	-25°C ~ 60°C
Certification	CE/ FCC	CE/ FCC	CE/ FCC	CE/ FCC
Released Date	2020/ 10	2020/ 10	2020/ 10	2020/ 10
Page Number	P. 64 - 65	P. 64 - 65	P. 64 - 65	P. 64 - 65

■ Rugged Embedded ■ Machine Vision ■ In-vehicle Computing ■ Surveillance/Video Analytics ■ GPU Computing ■ IoT Gateway



Model Name	Nuvo-6032	Nuvo-6002	POC-700	POC-500
Chassis				
Dimensions (W x D x H)	184 x 225x 174 mm	124 x 225 x 174 mm	64 x 116 x 176 mm	64x 116 x 176 mm (POC-515) 82x 118 x 176 mm (POC-545)
Weight	3.5 kg	2.8 kg	1.2 kg	1.2 kg (POC-515) 1.4 kg (POC-545)
Chassis Construction	Aluminum alloy with heavy duty metal	Aluminum alloy with heavy duty metal	Aluminum alloy with heavy duty metal	Aluminum alloy with heavy duty metal
System				
Processor	Intel® Core™ i7-6700TE Intel® Core™ i5-6500TE Intel® Core™ i3-6100TE Intel® Pentium® G4400TE Intel® Celeron® G3900TE	Intel® Core™ i7-6700TE Intel® Core™ i5-6500TE Intel® Core™ i3-6100TE Intel® Pentium® G4400TE Intel® Celeron® G3900TE	Intel® Alder Lake Core™ i3-N305	AMD Ryzen™ V1605B (POC-515) AMD Ryzen™ V1807B (POC-545)
Chipset	Intel® H110	Intel® H110	-	-
Graphics	Intel® HD Graphics 530/ 510	Intel® HD Graphics 530/ 510	Intel® HD Graphics with 32EUs	Vega GPU with 8 compute units (POC-515) Vega GPU with 11 compute units (POC-545)
Memory	Up to 16 GB DDR4-2133	Up to 16 GB DDR4-2133	Up to 16 GB DDR5-4800	Up to 32GB DDR4-2400 (POC-515) Up to 32GB DDR4-3200 (POC-545)
PoE	-	-	IEEE 802.3at (25.5W) for 4 GbE ports	IEEE 802.3at (25.5W) for 4 GbE ports
Ethernet	1x GbE by Intel® I219 1x GbE by Intel® I210	1x GbE by Intel® I219 1x GbE by Intel® I210	4x GbE by Intel® I350-AM4	4x GbE by Intel® I350
Video Port	2x DVI-D	2x DVI-D	1x DP++ 1x HDMI	1x VGA 1x DisplayPort
Serial Port	2x RS-232/422/485 3x 3-wire RS-232	2x RS-232/422/485 3x 3-wire RS-232	1x RS-232/422/485 3x 3-wire RS-232 or 1x RS-422/485	1x RS-232/422/485 3x 3-wire RS-232
USB 2.0	3 (internal)	3 (internal)	-	-
USB 3.2/ USB 3.1	4	4	4	4
Audio	1x mic-in and speaker-out	1x mic-in and speaker-out	-	1x mic-in and speaker-out
Digital I/O	-	-	4 DI +4 DO	Optional via MezIO® module
Storage Interface				
SATA HDD	3x 2.5" HDD/ SSD	1x 2.5" HDD/ SSD	Optional via MezIO® module	Optional via MezIO® module
mSATA	1	1	-	-
M.2 (M-key)	-	-	1	1
Mini PCI-E	-	-	1	1
M.2 (B-key/E-key)	-	-	-	-
SIM	-	-	1	1
MezIO®	-	-	Yes	Yes
PCI/PCI Express	1x PCI Express x16 slot 1x PCI Express x8 slot 3x 33MHz/32-bit PCI slots	1x PCI Express x16 slot 1x PCI Express x8 slot	-	-
Power Supply				
DC Input	8 to 35V DC	8 to 35V DC	8 to 35V DC	8 to 35V DC
Ignition Control	-	-	Optional via MezIO® module	Optional via MezIO® module
Environmental				
Operating Temperature	-25°C ~ 60°C	-25°C ~ 60°C	-25°C ~ 70°C	-25°C ~ 70°C
Certification	CE/ FCC	CE/ FCC	CE/ FCC, EN62368-1	CE/ FCC
Released Date	2016/ 6	2016/ 6	2023/ Q4	2019/ 9
Page Number	P. 68 - 69	P. 68 - 69	P. 72 - 73	P. 74 - 75

Selection Guide

■ Rugged Embedded ■ Machine Vision ■ In-vehicle Computing ■ Surveillance/Video Analytics ■ GPU Computing ■ IoT Gateway

Coming soon!



Model Name	POC-400	POC-465AWP	POC-40	POC-300		
Chassis	Dimensions (W x D x H)	56 x 108 x 153 mm	106 x 159.7x 79 mm	52 x 89 x 112 mm	56 x 108 x 153 mm	
	Weight	0.96 kg	1.45 kg	0.6 kg	0.96 kg	
	Chassis Construction	Aluminum alloy with heavy duty metal	Aluminum alloy with heavy duty metal	Aluminum alloy with heavy duty metal	Aluminum alloy with heavy duty metal	
System	Processor	Intel® Elkhart Lake Atom® x6425E	Intel® Elkhart Lake Atom® x6425E	Intel® Elkhart Lake Atom® x6211E	Intel® Atom™ E3950 quad-core Intel® Pentium™ N4200 quad-core	
	Chipset	-	-	-	-	
	Graphics	Intel® UHD Graphics	Intel® UHD Graphics	Intel® UHD Graphics	Intel® HD Graphics 505	
	Memory	Up to 32GB DDR4-3200	Up to 32GB DDR4-3200	Up to 32GB DDR4-3200	Up to 8GB DDR3L-1866	
	PoE	Optional (Port 2 to 3, IEEE 802.3at, 25.5W)	-	-	Optional (Port 2 to 3, IEEE 802.3at, 25.5W)	
I/O Interface	Ethernet	3x 2.5GBASE-T by Intel® I225	2x 2.5GbE by Intel® I226-IT via M12	2x GbE by Intel® I210	3x GbE by Intel® I210	
	Video Port	2x DisplayPort	1x VGA via M12	1x DisplayPort	1x DVI-I	
	Serial Port	1x RS-232/422/485 3x 3-wire RS-232	1x isolated RS-232 via M12 1x isolated RS-422/485 via M12	1x RS-232/422/485 1x 3-wire RS-232	1x RS-232/422/485 3x 3-wire RS-232	
	USB 2.0	2	2 (via M12)	2	2	
	USB 3.2/ USB 3.1	2	-	2	2	
	Audio	1x mic-in and speaker-out	-	1x mic-in and speaker-out	1x mic-in and speaker-out	
	Digital I/O	Optional via MezIO® module	-	Optional 4 DI + 4 DO	Optional via MezIO® module	
	Storage Interface	SATA HDD	Optional via MezIO® module	-	-	Optional via MezIO® module
		mSATA	-	-	-	1
		M.2 (M-key)	1	1	1	-
Mini PCI-E		-	1	-	1	
Expansion Bus	M.2 (B-key/E-key)	1x M.2 E-key	-	1x M.2 B-key 1x M.2 E-key	-	
	SIM	-	-	-	1	
	MezIO®	Yes	-	-	Yes	
	PCI/PCI Express	-	-	-	-	
Power Supply	DC Input	8 to 35V DC	8 to 35V DC	12 to 20V DC	8 to 35V DC	
	Ignition Control	Optional via MezIO® module	Built-in	Built-in (POC-40-IGN)	Optional via MezIO® module	
Environmental	Operating Temperature	-25°C ~ 70°C	-25°C ~ 70°C	-25°C ~ 70°C	-25°C ~ 70°C	
	Certification	CE/ FCC	CE/ FCC	CE/ FCC	CE/ FCC	
Released Date	2021/7	2023/Q4	2021/10	2017/ 5		
Page Number	P. 76 - 77	P. 82 - 83	P. 78 - 79	P. 80 - 81		

■ Rugged Embedded ■ Machine Vision ■ In-vehicle Computing ■ Surveillance/Video Analytics ■ GPU Computing ■ IoT Gateway

New!



Model Name	Nuvis-7306RT	Nuvis-5306RT	Nuvis-534RT	RGS-8805GC		
Chassis	Dimensions (W x D x H)	240 x 225 x 111 mm	240 x 225 x 111 mm	82 x 118 x 176 mm	444 x 350 x 88 mm	
	Weight	4.5 kg	4.5 kg	1.5 kg	8.6 kg	
	Chassis Construction	Aluminum alloy with heavy duty metal	Aluminum alloy with heavy duty metal	Aluminum alloy with heavy duty metal	Aluminum alloy with heavy duty metal	
System	Processor	Intel® Core™ i7-9700E/ i7-9700TE/ i7-8700/ i7-8700T Intel® Core™ i5-9500E/ i5-9500TE/ i5-8500/ i5-8500T	Intel® Core™ i7-6700/ 6700TE Intel® Core™ i5-6500/ 6500TE	AMD Ryzen™ V1807B	AMD® EPYC™ 7003 "Milan" series server CPU	
	Chipset	Intel® Q370	Intel® Q170	-	-	
	Graphics	Intel® UHD Graphics 630	Intel® HD Graphics 530	Vega GPU with 11 compute units	ASPEED AST2500 BMC	
	Memory	Up to 64 GB DDR4-2666/ 2400	Up to 32 GB DDR4-2133	Up to 32 GB DDR4-3200	Up to 512 GB DDR4-3200	
	PoE	IEEE 802.3at (25.5W) for 4 GbE ports	IEEE 802.3at (25.5W) for 4 GbE ports	IEEE 802.3at (25.5W) for 4 GbE ports	IEEE 802.3at (25.5W) for 4 GbE ports	
I/O Interface	Ethernet	6x GbE by Intel® I219 and I210	6x GbE by Intel® I219 and I210	4x GbE by Intel® I350	2x 10GBASE-T by Intel® X550-AT2 4x GbE by Intel® I350	
	Video Port	1x VGA 1x DVI-D 1x DisplayPort	1x VGA 1x DVI-D 2x DisplayPort	1x VGA 1x DisplayPort	1x VGA	
	Serial Port	2x RS-232/422/485 2x RS-232	2x RS-232/422/485 1x RS-232	1x RS-232/422/485 3x 3-wire RS-232	2x RS-232/422/485	
	USB 2.0	1 (internal)	4	-	-	
	USB 3.2/ USB 3.1	8	4	4	4	
	Audio	1x mic-in and speaker-out	1x mic-in and speaker-out	1x mic-in and speaker-out	-	
	Digital I/O	Patented DTIO/ NuMCU for real-time trigger control	Patented DTIO/ NuMCU for real-time trigger control	Patented DTIO/ NuMCU for real-time trigger control	-	
	Storage Interface	SATA HDD	2x 2.5" HDD/ SSD	2x 2.5" HDD/ SSD	-	4x Easy-swap tray for 2.5" HDD/ SSD
		mSATA	1 (mux. with mini-PCIe)	1 (mux. with mini-PCIe)	-	-
		M.2 (M-key)	1	-	1	1
Mini PCI-E		1	2	-	2	
Expansion Bus	M.2 (B-key/ E-Key)	1x M.2 B-key	-	-	1x M.2 B-key	
	SIM	3	2	-	4	
	MezIO®	-	-	-	-	
	PCI/PCI Express	2x PCIe x16 slot, supports - Independent NVIDIA® GPU (120W) - COTS CameraLink and CoaXPress camera interface card	1x PCIe x16 slot, supports - Independent NVIDIA® GPU (75W) - COTS CameraLink and CoaXPress camera interface card	-	1x PCIe x16 slot @ Gen4, 16-lanes supporting NVIDIA® RTX A6000/ A4500 2x PCIe x16 slots @ Gen4, 8-lanes	
Power Supply	DC Input	8 to 35V DC	8 to 35V DC	8 to 35V DC	8 to 48V DC	
	Ignition Control	-	-	-	Built-in	
Environmental	Operating Temperature	with 35W CPU -25°C ~ 60°C with 65W CPU -25°C ~ 50°C	with 35W CPU -25°C ~ 60°C with 65W/ 51W CPU -25°C ~ 50°C	-25°C ~ 70°C	-20°C ~ 60°C	
	Certification	CE/ FCC	CE/ FCC	CE/ FCC	CE/ FCC	
Released Date	2021 Q2	2017/ 3	2021 Q2	2022/12		
Page Number	P. 100 - 101	P. 102 - 103	P. 104 - 105	P. 152 - 153		

Selection Guide

■ Rugged Embedded ■ Machine Vision ■ In-vehicle Computing ■ Surveillance/Video Analytics ■ GPU Computing ■ IoT Gateway

Coming soon!



Model Name	Nuvo-10208GC	Nuvo-8208GC	Nuvo-8108GC	Nuvo-8108GC-XL
Chassis				
Dimensions (W x D x H)	268 x 400 x 196 mm	235 x 360 x 186 mm	170 x 360 x 198 mm	193 x 388 x 198 mm
Weight	6.5 kg	8.6 kg	5 kg	5.2 kg
Chassis Construction	Aluminum alloy with heavy duty metal	Aluminum alloy with heavy duty metal	Aluminum alloy with heavy duty metal	Aluminum alloy with heavy duty metal
System				
Processor	- Intel® Core™ i9-13900E/ i9-12900E/ i9-12900TE - Intel® Core™ i7-13700E/ i7-13700TE - Intel® Core™ i5-13500E/ i5-13400E/ i5-13500TE - Intel® Core™ i3-13100E/ i3-13100TE - Intel® Pentium® G7400E/ G7400TE - Intel® Celeron® G6900E/ G6900TE	Intel® Xeon® E-2176G/ E-2278GE/ E-2278GEL Intel® Core™ i7-9700E/ i7-9700TE/ i7-8700/ i7-8700T Intel® Core™ i5-9500E/ i5-9500TE/ i5-8500/ i5-8500T Intel® Core™ i3-9100E/ i3-9100TE/ i3-8100/ i3-8100T	Intel® Xeon® E-2176G/ E-2278GE/ E-2278GEL Intel® Core™ i7-9700E/ i7-9700TE/ i7-8700/ i7-8700T Intel® Core™ i5-9500E/ i5-9500TE/ i5-8500/ i5-8500T Intel® Core™ i3-9100E/ i3-9100TE/ i3-8100/ i3-8100T	Intel® Xeon® E-2176G/ E-2278GE/ E-2278GEL Intel® Core™ i7-9700E/ i7-9700TE/ i7-8700/ i7-8700T Intel® Core™ i5-9500E/ i5-9500TE/ i5-8500/ i5-8500T Intel® Core™ i3-9100E/ i3-9100TE/ i3-8100/ i3-8100T
Chipset	Intel® R680E	Intel® C246	Intel® C246	Intel® C246
Graphics	Intel® HD Graphics 770/ 730	x16 PEG port, or Intel® HD Graphics 630	x16 PEG port, or Intel® UHD Graphics 630	x16 PEG port, or Intel® HD Graphics 630
Memory	Up to 64 GB DDR5-4800	Up to 128 GB DDR4-2133	Up to 128 GB DDR4-2133	Up to 128 GB DDR4-2133
PoE	-	-	-	-
Ethernet	2x 2.5GbE by Intel® I226-IT 1x GbE by Intel® I219LM	1x GbE by Intel® I219 1x GbE by Intel® I210	1x GbE by Intel® I219 1x GbE by Intel® I210	1x GbE by Intel® I219 1x GbE by Intel® I210
Video Port	1x VGA 1x DisplayPort	1x VGA 1x DVI-D 1x DisplayPort	1x VGA 1x DVI-D 1x DisplayPort	1x VGA 1x DVI-D 1x DisplayPort
Serial Port	2x RS-232/422/485	2x RS-232/422/485	2x RS-232/422/485	2x RS-232/422/485
USB 2.0	1 (internal)	1 (internal)	1 (internal)	1 (internal)
USB 3.2/ USB 3.1	6	8	8	8
Audio	1x mic-in and speaker-out	1x mic-in and speaker-out	1x mic-in and speaker-out	1x mic-in and speaker-out
Digital I/O	-	-	-	-
Storage Interface				
SATA HDD	2x hot-swap tray for 2.5" HDD/ SSD	2x hot-swap tray for 2.5" HDD/ SSD	1x 2.5" HDD/ SSD 1x hot-swap tray for 2.5" HDD/ SSD	1x 2.5" HDD/ SSD 1x hot-swap tray for 2.5" HDD/ SSD
mSATA	-	2 (mux. with mini-PCIe)	2 (mux. with mini-PCIe)	2 (mux. with mini-PCIe)
M.2 (M-key)	1+1 optional M.2 tray	1	1	1
Mini PCI-E	2	2	2	2
M.2 (B-key/E-key)	1x M.2 B-key	1x M.2 B-key	1x M.2 B-key	1x M.2 B-key
SIM	3	4	4	4
MezIO®	-	-	-	-
PCI/PCI Express	2x PCIe x16 slot@Gen4, 8-lanes 3x PCIe x8 slot@Gen3, 4-lanes	2x PCIe x16 slot @ Gen3, 8-lanes supporting NVIDIA® RTX 30 series 2x PCIe x8 slots @ Gen3, 4-lanes 1x PCIe x4 slot @ Gen3, 1-lane (Installing a GPU card will obstruct one PCIe slot!)	1x PCIe x16 slot @ Gen3, 8-lanes supporting NVIDIA® RTX 30 series 1x PCIe x16 slot @ Gen3, 8-lanes 2x PCIe x8 slots @ Gen3, 4-lanes (Installing a GPU card will obstruct one PCIe slot!)	1x PCIe x16 slot @ Gen3, 8-lanes supporting NVIDIA® RTX 3080 1x PCIe x16 slot @ Gen3, 8-lanes 2x PCIe x8 slots @ Gen3, 4-lanes (Installing a GPU card will obstruct one PCIe slot!)
Power Supply				
DC Input	8 to 48V DC	8 to 35V DC	8 to 48V DC	8 to 48V DC
Ignition Control	Built-in	Built-in	Built-in	Built-in
Environmental				
Operating Temperature	With 35W CPU and dual 350W GPU -25°C ~ 60°C With 65W CPU and dual 350W GPU -25°C ~ 60°C (with fan kit) -25°C ~ 50°C (without fan kit)	-25°C ~ 60°C	-25°C ~ 60°C	-25°C ~ 60°C
Certification	CE/ FCC	CE/ FCC	CE/ FCC	CE/ FCC
Released Date	2023/ 6	2019/ 5	2019/ 11	2021/ 1
Page Number	P. 154 - 155	P. 156 - 157	P. 162 - 163	P. 158 - 159

■ Rugged Embedded ■ Machine Vision ■ In-vehicle Computing ■ Surveillance/Video Analytics ■ GPU Computing ■ IoT Gateway



Model Name	Nuvo-8108GC-QD	Nuvo-8240GC	Nuvo-6108GC	Nuvo-6108GC-IGN
Chassis				
Dimensions (W x D x H)	170.2 x 360 x 201.8 mm	190 x 271 x 198.5 mm	167 x 360 x 174 mm	178 x 360 x 174 mm
Weight	5.8 kg	5 kg	4.7 kg	4.7 kg
Chassis Construction	Aluminum alloy with heavy duty metal	Aluminum alloy with heavy duty metal	Aluminum alloy with heavy duty metal	Aluminum alloy with heavy duty metal
System				
Processor	Intel® Xeon® E-2176G/ E-2278GE/ E-2278GEL Intel® Core™ i7-9700E/ i7-9700TE/ i7-8700/ i7-8700T Intel® Core™ i5-9500E/ i5-9500TE/ i5-8500/ i5-8500T Intel® Core™ i3-9100E/ i3-9100TE/ i3-8100/ i3-8100T	Intel® Xeon® E-2176G/ E-2278GE/ E-2278GEL Intel® Core™ i7-9700E/ i7-9700TE/ i7-8700/ i7-8700T Intel® Core™ i5-9500E/ i5-9500TE/ i5-8500/ i5-8500T Intel® Core™ i3-9100E/ i3-9100TE/ i3-8100/ i3-8100T	Intel® Xeon™ E3-1275 v5 Intel® Xeon™ E3-1268L v5 Intel® Core™ i7-6700/ 6700TE Intel® Core™ i5-6500/ 6500TE	Intel® Xeon™ E3-1275 v5 Intel® Xeon™ E3-1268L v5 Intel® Core™ i7-6700/ 6700TE Intel® Core™ i5-6500/ 6500TE
Chipset	Intel® C246	Intel® C246	Intel® C236	Intel® C236
Graphics	x16 PEG port, or Intel® HD Graphics 630	Intel® UHD Graphics 630	x16 PEG port, or Intel® HD Graphics 530	x16 PEG port, or Intel® HD Graphics 530
Memory	Up to 128 GB DDR4-2133	Up to 128 GB DDR4-2133	Up to 32 GB DDR4-2133	Up to 32 GB DDR4-2133
PoE	-	-	-	-
Ethernet	1x GbE by Intel® I219 1x GbE by Intel® I210	1x GbE by Intel® I219 1x GbE by Intel® I210	1x GbE by Intel® I219 1x GbE by Intel® I210	1x GbE by Intel® I219 1x GbE by Intel® I210
Video Port	1x VGA 1x DVI-D 1x DisplayPort	1x VGA 1x DVI-D 1x DisplayPort	2x DVI-D	2x DVI-D
Serial Port	2x RS-232/422/485	2x RS-232/422/485	2x RS-232/422/485	2x RS-232/422/485
USB 2.0	1 (internal)	1 (internal)	1 (internal)	1 (internal)
USB 3.2/ USB 3.1	8	8	4	4
Audio	1x mic-in and speaker-out	1x mic-in and speaker-out	1x mic-in and speaker-out	1x mic-in and speaker-out
Digital I/O	-	-	-	-
Storage Interface				
SATA HDD	1x 2.5" HDD/ SSD 1x hot-swap tray for 2.5" HDD/ SSD	1x 2.5" HDD/ SSD 1x hot-swap tray for 2.5" HDD/ SSD	4x 2.5" HDD/ SSD	2x easy-swap tray for 2.5" HDD/ SSD 1x 2.5" HDD/ SSD
mSATA	2 (mux. with mini-PCIe)	2 (mux. with mini-PCIe)	-	-
M.2 (M-key)	1	1	-	-
Mini PCI-E	2	2	1	1
M.2 (B-key/E-key)	1x M.2 B-key	1x M.2 B-key	1x M.2 B-key	1x M.2 B-key
SIM	4	4	1	1
MezIO®	-	-	-	-
PCI/PCI Express	1x PCIe x16 slot @ Gen3, 8-lanes supporting NVIDIA® RTX A6000/ A4500 1x PCIe x16 slot @ Gen3, 8-lanes 2x PCIe x8 slots @ Gen3, 4-lanes (Installing a GPU card will obstruct one PCIe slot!)	2x PCIe x16 slot, supporting NVIDIA® Tesla T4 GPU 2x PCIe x8 slots @ Gen3, 4-lanes	1x PCIe x16 slot @ Gen3, 16-lanes, supporting NVIDIA® RTX 3070 GPU 2x PCIe x8 slot @ Gen3, 4-lanes	1x PCIe x16 slot @ Gen3, 16-lanes, supporting NVIDIA® RTX 3070 GPU 2x PCIe x8 slot @ Gen3, 4-lanes
Power Supply				
DC Input	8 to 48V DC	8 to 48V DC	24V DC	24V DC
Ignition Control	Built-in	Built-in	Built-in	Built-in
Environmental				
Operating Temperature	-25°C ~ 60°C	-25°C ~ 60°C	-25°C ~ 60°C	-25°C ~ 60°C
Certification	CE/ FCC	CE/ FCC	CE/ FCC, UL 62368-1	CE/ FCC
Released Date	2022/ 1	2020/ 1	2018/ 6	2018/ 6
Page Number	P. 160 - 161	P. 164 - 166	P. 166 - 167	P. 166 - 167

Selection Guide

■ Rugged Embedded ■ Machine Vision ■ In-vehicle Computing ■ Surveillance/Video Analytics ■ GPU Computing ■ IoT Gateway

New!



Model Name	Nuvo-9160GC	Nuvo-7168GC	Nuvo-7166GC/ 7164GC	Nuvo-7160GC
Chassis				
Dimensions (W x D x H)	240 x 225 x 110.5 mm	240 x 225 x 111 mm	240 x 225 x 111 mm	240 x 225 x 111 mm
Weight	3.58 kg	4.5 kg	4.5 kg	4.5 kg
Chassis Construction	Aluminum alloy with heavy duty metal	Aluminum alloy with heavy duty metal	Aluminum alloy with heavy duty metal	Aluminum alloy with heavy duty metal
System				
Processor	- Intel® Core™ i9-13900E/ i9-12900E/ i9-12900TE - Intel® Core™ i7-13700E/ i7-13700TE/ i7-12700E/ i7-12700TE - Intel® Core™ i5-13500E/ i5-13400E/ i5-13500TE - Intel® Core™ i5-12500E/ i5-12500TE - Intel® Core™ i3-13100E/ i3-13100TE/ i3-12100E/ i3-12100TE - Intel® Pentium® G7400E/ G7400TE - Intel® Celeron® G6900E/ G6900TE	Intel® Core™ i7-9700E/ i7-9700TE/ i7-8700E/ i7-8700TE Intel® Core™ i5-9500E/ i5-9500TE/ i5-8500E/ i5-8500TE	Intel® Core™ i7-9700E/ i7-9700TE/ i7-8700E/ i7-8700TE Intel® Core™ i5-9500E/ i5-9500TE/ i5-8500E/ i5-8500TE	Intel® Core™ i7-9700E/ i7-9700TE/ i7-8700E/ i7-8700TE Intel® Core™ i5-9500E/ i5-9500TE/ i5-8500E/ i5-8500TE
Chipset	Intel® Q670E	Intel® Q370	Intel® Q370	Intel® Q370
Graphics	Intel® UHD Graphics 770/ 730	Intel® UHD Graphics 630	Intel® UHD Graphics 630	x16 PEG port, or Intel® UHD Graphics 630
Memory	Up to 64 GB DDR5 4800	Up to 64 GB DDR4-2666/ 2400	Up to 64 GB DDR4-2666/ 2400	Up to 64 GB DDR4-2666/ 2400
PoE	Optional (Port 3 to 6, IEEE 802.3at, 25.5W)	Optional (Port 3 to 6, IEEE 802.3at, 25.5W)	Optional (Port 3 to 6, IEEE 802.3at, 25.5W)	Optional (Port 3 to 6, IEEE 802.3at, 25.5W)
I/O Interface				
Ethernet	5x 2.5GbE (I225) and 1x GbE (I219)	6x GbE by Intel® I219 and I210	6x GbE by Intel® I219 and I210	6x GbE by Intel® I219 and I210
Video Port	1x VGA 1x DVI-D 1x DisplayPort	1x VGA 1x DVI-D 1x DisplayPort	1x VGA 1x DVI-D 1x DisplayPort	1x VGA 1x DVI-D 1x DisplayPort
Serial Port	2x RS-232/422/485 2x RS-232	2x RS-232/422/485 2x RS-232	2x RS-232/422/485 2x RS-232	2x RS-232/422/485 2x RS-232
USB 2.0	2	1 (internal)	1 (internal)	1 (internal)
USB 3.2/ USB 3.1	7 (incl. 1x 20Gbps type-C)	8	8	8
Audio	1x mic-in and speaker-out	1x mic-in and speaker-out	1x mic-in and speaker-out	1x mic-in and speaker-out
Digital I/O	Optional via MezIO® module	Optional via MezIO® module	Optional via MezIO® module	Optional via MezIO® module
Storage Interface				
SATA HDD	2x 2.5" HDD/ SSD	2x 2.5" HDD/ SSD	2x 2.5" HDD/ SSD	2x 2.5" HDD/ SSD
mSATA	-	1 (mux. with mini-PCIe)	1 (mux. with mini-PCIe)	1 (mux. with mini-PCIe)
M.2 (M-key)	1 (Gen4 x4)	1	1	1
Mini PCI-E	1	1	1	1
M.2 (B-key/ E-Key)	1x M.2 B-key	1x M.2 B-key	1x M.2 B-key	1x M.2 B-key
Expansion Bus				
SIM	2	3	3	3
MezIO®	Yes	Yes	Yes	Yes
PCI/PCI Express	1x PCIe x16 slot, supporting NVIDIA® GPU (130W)	1x PCIe x16 slot @ Gen3, 16-lanes, supporting NVIDIA® RTX A2000	1x PCIe x16 slot, supporting NVIDIA® Tesla T4 GPU (Nuvo-7164GC) 2x PCIe x16 slot, supporting NVIDIA® Tesla T4 GPU and one additional PCIe card (Nuvo-7166GC)	1x PCIe x16 slot, supporting NVIDIA® GPU (120W)
Power Supply				
DC Input	8 to 48V DC	8 to 35V DC	8 to 35V DC	8 to 35V DC
Ignition Control	Optional via MezIO® module	Optional via MezIO® module	Optional via MezIO® module	Optional via MezIO® module
Environmental				
Operating Temperature	with 35W CPU and 130W GPU -25°C ~ 60°C with 65W CPU and 130W GPU -25°C ~ 50°C	with 35W CPU -25°C ~ 60°C with 65W CPU -25°C ~ 50°C	with 35W CPU -25°C ~ 60°C with 65W CPU -25°C ~ 50°C	with 35W CPU and 120W GPU -25°C ~ 60°C with 65W CPU and 120W GPU -25°C ~ 50°C
Certification	CE/ FCC	CE/ FCC	CE/ FCC	CE/ FCC
Released Date	2023/2	2022/ 3	2019/ 3	2018/ 10
Page Number	P. 168 - 169	P. 170 - 171	P. 172 - 173	P. 174 - 175

■ Rugged Embedded ■ Machine Vision ■ In-vehicle Computing ■ Surveillance/Video Analytics ■ GPU Computing ■ IoT Gateway

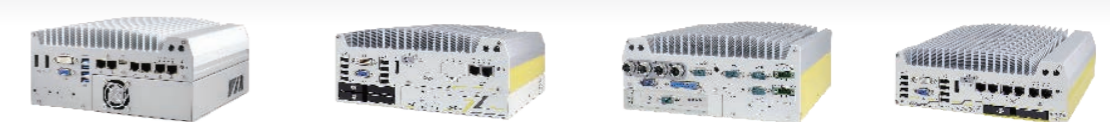

Model Name	Nuvo-5095GC	Nuvo-7200VTC	Nuvo-7250VTC	Nuvo-7100VTC
Chassis				
Dimensions (W x D x H)	240 x 225 x 111 mm	240 x 225 x 103 mm	240 x 225 x 103 mm	240 x 225 x 84 mm
Weight	4.5 kg	3.7 kg	4.1 kg	3.5 kg
Chassis Construction	Aluminum alloy with heavy duty metal	Aluminum alloy with heavy duty metal	Aluminum alloy with heavy duty metal	Aluminum alloy with heavy duty metal
System				
Processor	Intel® Core™ i7-6700/ 6700TE Intel® Core™ i5-6500/ 6500TE	Intel® Core™ i7-9700E/ i7-8700E/ i7-8700TE/ i7-8700TE Intel® Core™ i5-9500E/ i5-8500E/ i5-8500TE	Intel® Core™ i7-9700E/ i7-8700E/ i7-8700TE Intel® Core™ i5-9500E/ i5-8500E/ i5-8500TE	Intel® Core™ i7-9700E/ i7-8700E/ i7-8700TE Intel® Core™ i5-9500E/ i5-8500E/ i5-8500TE
Chipset	Intel® Q170	Intel® Q370	Intel® Q370	Intel® Q370
Graphics	x16 PEG port, or Intel® HD Graphics 530/ 510	Intel® UHD Graphics 630	Intel® HD Graphics 630	Intel® HD Graphics 630
Memory	Up to 32 GB DDR4-2133	Up to 64 GB DDR4-2666	Up to 64 GB DDR4-2666	Up to 64 GB DDR4-2666
PoE	Optional (Port 3 to 6, IEEE 802.3at, 25.5W)	IEEE 802.3at (25.5W) for 4x/ 8x GbE ports	IEEE 802.3at (25.5W) for 4x/ 8x GbE ports	IEEE 802.3at (25.5W) for 4x/ 8x GbE ports
I/O Interface				
Ethernet	6x GbE by Intel® I219 and I210	2x GbE by Intel® I219 and I210 (RJ-45) 4x/ 8x GbE by Intel® I210 (M12 x-coded or RJ-45)	2x GbE by Intel® I219 and I210 (RJ-45) 4x/ 8x GbE by Intel® I210 (M12 x-coded or RJ-45)	2x GbE by Intel® I219 and I210 (RJ-45) 4x/ 8x GbE by Intel® I210 (M12 x-coded or RJ-45)
Video Port	1x VGA 1x DVI-D 2x DisplayPort	1x VGA 1x DVI-D 1x DisplayPort	1x VGA 1x DVI-D 1x DisplayPort	1x VGA 1x DVI-D 1x DisplayPort
Serial Port	2x RS-232/422/485 1x RS-232	2x RS-232/422/485 2x RS-232	2x RS-232/422/485 2x RS-232	2x RS-232/422/485 2x RS-232
USB 2.0	4	1 (internal)	1 (internal)	1 (internal)
USB 3.2/ USB 3.1	4	8	8	8
Audio	1x mic-in and speaker-out	1x mic-in and speaker-out	1x mic-in and speaker-out	1x mic-in and speaker-out
Digital I/O	Optional via MezIO® module	4 DI + 4 DO Polling, Change of State (COS)	4 DI + 4 DO Polling, Change of State (COS)	4 DI + 4 DO Polling, Change of State (COS)
Storage Interface				
SATA HDD	2x 2.5" HDD/ SSD	2x hot-swap tray for 2.5" HDD/ SSD	2x hot-swap tray for 2.5" HDD/ SSD	1x 2.5" HDD/ SSD 1x hot-swap tray for 2.5" HDD/ SSD
mSATA	1 (mux. with mini-PCIe)	1 (mux. with mini-PCIe)	1 (mux. with mini-PCIe)	1 (mux. with mini-PCIe)
M.2 (M-key)	-	1	1	1
Expansion Bus				
Mini PCI-E	2	3	3	3
M.2 (B-key/ E-Key)	-	2x M.2 B-key	2x M.2 B-key	2x M.2 B-key
SIM	2	6	6	6
MezIO®	Yes	-	-	-
PCI/PCI Express	1x PCIe x16 slot, supporting NVIDIA® GPU (75W)	1x PCIe x16 slot@Gen3, 16-lanes	1x PCIe with PB-2500J pre-installed	-
Power Supply				
DC Input	8 to 35V DC	8 to 35V DC	8 to 35V DC with SuperCAP UPS	8 to 35V DC
Ignition Control	Optional via MezIO® module	Built-in	Built-in	Built-in
Environmental				
Operating Temperature	with 35W CPU -25°C ~ 60°C with 65W/ 51W CPU -25°C ~ 50°C	-40°C ~ 70°C	-40°C ~ 70°C	-40°C ~ 70°C
Certification	CE/ FCC	E-Mark, EN45545, EN50155, CE/ FCC	E-Mark, EN45545, EN50155, CE/ FCC	E-Mark, EN45545, EN50155, CE/ FCC
Released Date	2016/ 12	2020/ 1	2020/ 1	2020/ 1
Page Number	P. 176 - 177	P. 114 - 115	P. 116 - 117	P. 118 - 119

Selection Guide

■ Rugged Embedded ■ Machine Vision ■ In-vehicle Computing ■ Surveillance/Video Analytics ■ GPU Computing ■ IoT Gateway

New! Coming soon!



Model Name	Nuvo-5100VTC	Nuvo-2610VTC	Nuvo-2615RL	POC-551VTC
Chassis				
Dimensions (W x D x H)	240 x 225 x 79 mm	205 x 155 x 58 mm (Nuvo-2610VTC) 205 x 155 x 86 mm (Nuvo-2611VTC) 205 x 155 x 86 mm (Nuvo-2612VTC)	205 x 155 x 86 mm	176 x 116 x 64 mm
Weight	3.3 kg	1.9 kg (Nuvo-2610VTC) 2.5 kg (Nuvo-2611VTC) 2.3 kg (Nuvo-2612VTC)	2.7 kg	1.3 kg
Chassis Construction	Aluminum alloy with heavy duty metal	Aluminum alloy with heavy duty metal	Aluminum alloy with heavy duty metal	Aluminum alloy with heavy duty metal
System				
Processor	Intel® Core™ i7-6700TE Intel® Core™ i5-6500TE Intel® Core™ i3-6100TE	Intel® Elkhart Lake Atom® x6425E	Intel® Elkhart Lake Atom® x6425E	AMD Ryzen™ V1605B
Chipset	Intel® Q170	-	-	-
Graphics	Intel® HD Graphics 530	Intel® UHD Graphics	Intel® UHD Graphics	Vega GPU with 6 compute units
Memory	Up to 32 GB DDR4-2133	Up to 32GB DDR4-3200	Up to 32GB DDR4-3200	Up to 16 GB DDR4-2400
I/O Interface				
PoE	IEEE 802.3at (25.5W) for 4x/ 8x GbE ports	IEEE 802.3at (25.5W) for 4 GbE ports via M12	IEEE 802.3at (25.5W) for 4 GbE ports via M12	IEEE 802.3at (25.5W) for 4 GbE ports
Ethernet	2x GbE by Intel® I219 and I210 (RJ-45) 4x/ 8x GbE by Intel® I210(M12 x-coded or RJ-45)	4x GbE by Intel® I210	4x GbE by Intel® I210	4x GbE by Intel® I350
Video Port	1x VGA 1x DVI-D 2x DisplayPort	1x DVI-I	1x DVI-I	1x VGA 1x DisplayPort
Serial Port	2x RS-232/422/485 1x RS-232	1x isolated RS-485 3x 3-wire RS-232 or 1x RS-422/485	1x isolated RS-485 3x 3-wire RS-232 or 1x RS-422/485	1x RS-232/422/485 3x 3-wire RS-232
USB 2.0	4	2	2	-
USB 3.2/ USB 3.1	4	1	1	4
Audio	1x mic-in and speaker-out	1x mic-in and speaker-out	1x mic-in and speaker-out	1x mic-in and speaker-out
Digital I/O	4 DI + 4 DO Polling, Change of State (COS)	4 DI + 4 DO	4 DI + 4 DO	4 DI + 4 DO Polling, Change of State (COS)
Storage Interface				
SATA HDD	1x 2.5" HDD/ SSD 1x hot-swap tray for 2.5" HDD/ SSD	1x front-accessible HDD tray for 2.5" HDD/ SSD	1x front-accessible HDD tray for 2.5" HDD/ SSD	-
mSATA	1 (mux. with mini-PCIe)	-	-	1x mSATA
M.2 (M-key)	-	1	1	1
Mini PCI-E	4	2	2	3
M.2 (B-key/ E-Key)	-	1x B-key	1x B-key	1x B-key
SIM	4	2	2	4
MezIO®	-	-	-	-
PCI/PCI Express	-	1x PCIe x4 slot @ Gen3, 2-lanes PCIe signals in Cassette (Nuvo-2612VTC)	1x PCIe with PB-2500J pre-installed	-
Power Supply				
DC Input	8 to 35V DC	8 to 35V DC	43 to 160V DC	8 to 35V DC
Ignition Control	Built-in	Built-in	Built-in	Built-in
Environmental				
Operating Temperature	-40°C ~ 70°C	-40°C ~ 70°C	-40°C ~ 70°C	-40°C ~ 70°C
Certification	E-Mark, EN45545, EN50155, CE/ FCC	E-Mark, EN50155, EN45545, CE/ FCC	EN45545-2, EN50155, CE/ FCC	E-Mark, EN50155, EN45545, CE/ FCC
Released Date	2016/ 6	2022/ 9	2023/ 6	2020/ 6
Page Number	P. 166 - 167	P. 122 - 123	P. 124 - 125	P. 126 - 127

■ Rugged Embedded ■ Machine Vision ■ In-vehicle Computing ■ Surveillance/Video Analytics ■ GPU Computing ■ IoT Gateway

Coming soon!

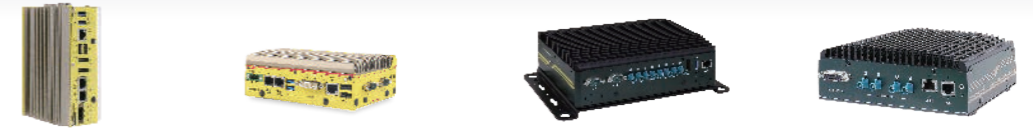

Model Name	POC-451VTC	POC-351VTC	NRU-110V	NRU-51V
Chassis				
Dimensions (W x D x H)	153 x 108 x 72 mm	153 x 108 x 56 mm (POC-351VTC) 153 x 108 x 68 mm (POC-351VTC-70)	230 x 173 x 66 mm	173 x 144 x 60 mm
Weight	1.4 kg	1.0 kg (POC-351VTC) 1.1 kg (POC-351VTC-70)	2.7 kg	1.4kg
Chassis Construction	Aluminum alloy with heavy duty metal	Aluminum alloy with heavy duty metal	Aluminum alloy with heavy duty metal	Aluminum alloy with heavy duty metal
System				
Processor	Intel® Elkhart Lake Atom® x6425E	Intel® Atom™ E3950 quad-core	NVIDIA® Jetson AGX Xavier™	NVIDIA® Jetson Xavier™ NX
Chipset	-	-	-	-
Graphics	Intel® UHD Graphics	Intel® HD Graphics 505	-	-
Memory	Up to 32GB DDR4-3200	Up to 8GB DDR3L-1866	32GB LPDDR4x @ 2133 MHz	NX 8GB/ 16GB @ 1600/ 1866 MHz
I/O Interface				
PoE	IEEE 802.3at (25.5W) for 2 GbE ports	IEEE 802.3at (25.5W) for 2 GbE ports	-	-
Ethernet	3x 2.5GBASE-T by Intel® I225	3x GbE by Intel® I210	1x 10GBASE-T 10G by Intel® X550-AT	1x 10GBASE-T 10G 1x 1GBASE-T 1GbE
Video Port	2x DisplayPort	1x DVI-I	2x DisplayPort	1x DisplayPort
Serial Port	1x RS-232/422/485 3x 3-wire RS-232	1x RS-232/422/485 3x 3-wire RS-232	1x RS-232	1x RS-232
USB 2.0	2	2	-	-
USB 3.2/ USB 3.1	2	2	3	2
Audio	1x mic-in and speaker-out	1x mic-in and speaker-out	-	-
Digital I/O	4 DI + 4 DO Polling, Change of State (COS)	4 DI + 4 DO Polling, Change of State (COS)	1x GPS PPS, 3 DI + 4 DO	1x GPS PPS, 3 DI + 4 DO
Storage Interface				
SATA HDD	-	-	-	-
mSATA	-	2x mSATA	-	-
M.2 (M-key)	2	-	1	1
Mini PCI-E	1	3	1	2
M.2 (B-key/ E-Key)	1x M.2 B-key 2x M.2 E-key	1x M.2 B-key	-	1x M.2 B-key
SIM	3	4	1	1
MezIO®	-	-	-	-
PCI/PCI Express	-	-	-	-
Power Supply				
DC Input	8 to 35V DC	8 to 35V DC	8 to 35V DC	8 to 35V DC
Ignition Control	Built-in	Built-in	Built-in	Built-in
Environmental				
Operating Temperature	-25°C ~ 70°C	-25°C ~ 70°C -40°C ~ 70°C (optional)	-25°C ~ 50°C (MAX TDP mode) -25°C ~ 70°C (30W TDP mode) -25°C ~ 70°C with optional fan kit (all modes)	-25°C ~ 60°C (15W TDP mode) -25°C ~ 70°C with optional fan kit (15W TDP mode)
Certification	E-Mark, CE/ FCC	E-Mark, CE/ FCC	CE/ FCC	CE/ FCC
Released Date	2022/ 8	2018/ 7	2021/ 2	2023/ Q3
Page Number	P. 128 - 129	P. 130 - 131	P. 132 - 133	P. 134 - 135

■ Rugged Embedded ■ Machine Vision ■ In-vehicle Computing ■ Surveillance/Video Analytics ■ GPU Computing ■ IoT Gateway

Coming soon!

Coming soon!



Model Name	NRU-220S	NRU-120S	NRU-52S	Nuvo-5608VR	
Chassis	Dimensions (W x D x H)	230 x 173 x 66 mm	230 x 173 x 66 mm	173 x 144 x 59 mm	
	Weight	TBD	2.7 kg	1.4 kg	
	Chassis Construction	Aluminum alloy with heavy duty metal	Aluminum alloy with heavy duty metal	Aluminum alloy with heavy duty metal	Aluminum alloy with heavy duty metal
System	Processor	NVIDIA® Jetson AGX Orin™	NVIDIA® Jetson AGX Xavier™	NVIDIA® Jetson Xavier™ NX	
	Chipset	-	-	-	
	Graphics	-	-	-	
	Memory	AGX Orin 32GB/ 64GB @ 3200 MHz	32GB LPDDR4x @ 2133 MHz	8GB LPDDR4x @ 1600 MHz (15W TDP) 8GB LPDDR4x @ 1866 MHz (20W TDP)	Up to 32 GB DDR4-2133 Intel® Core™ i7-6700/6700TE Intel® Core™ i5-6500/6500TE Intel® Core™ i3-6100/6100TE
I/O Interface	PoE	IEEE 802.3bt PoE++ for 4 GbE ports	IEEE 802.3at (25.5W) for 4 GbE ports	IEEE 802.3bt PoE++ for 4 GbE ports	
	Ethernet	2x 2.5GbE by Intel® I225 4x 1Gbps	-	4x GbE ports	2x GbE by Intel® I219 and I210 8x GbE by Intel® I210
	Video Port	1x DisplayPort	2x DisplayPort	1x DisplayPort	1x VGA + DVI-D 2x DisplayPort
	Serial Port	1x isolated RS-485 2x RS-232	1x RS-232	1x RS-232/422/485	2x RS-232/422/485 1x RS-232
	USB 2.0	2	-	-	4
	USB 3.2/ USB 3.1	1	3	2	4
	Audio	-	-	-	1x mic-in and speaker-out
	Digital I/O	4 DI + 4 DO	1x GPS PPS, 3 DI + 4 DO	1x GPS PPS, 3 DI + 4 DO	4 DI + 4 DO Polling, COS
	Storage Interface	SATA HDD	2x front-accessible 2.5" 7mm SSD	2x front-accessible 2.5" HDD/SSD	-
		mSATA	-	-	-
M.2 (M-key)		-	1	-	-
Mini PCI-E		2	1	2	4
Expansion Bus	M.2 (B-key/ E-Key)	1x B-key	-	1x B-key	-
	SIM	2	1	2	4
	MezIO®	-	-	-	-
	PCI/PCI Express	-	-	-	-
Power Supply	DC Input	8 to 48V DC	8 to 35V DC	8 to 35V DC	8 to 35V DC
	Ignition Control	Built-in	Built-in	Built-in	Built-in
Environmental	Operating Temperature	-25°C ~ 70°C (30 W TDP mode)	-25°C ~ 50°C (MAX TDP mode) -25°C ~ 70°C (30W TDP mode) -25°C ~ 70°C with optional fan kit (all modes)	-25°C ~ 70°C (15W TOP mode with 50W PoE++) -25°C ~ 70°C with optional fan kit (15W TOP mode with 144W PoE++)	35W CPU -25°C ~ 70°C (with mSATA/ SSD) -10°C ~ 60°C (with 3.5" HDD) 65W CPU -25°C ~ 50°C (with mSATA/ SSD) -10°C ~ 60°C (with 3.5" HDD)
	Certification	CE/ FCC	CE/ FCC	EN50155, CE/ FCC	CE/ FCC
Released Date	2023/ Q2	2021/ 2	2023/ Q3	2018/ 2	
Page Number	P. 142 - 143	P. 144 - 145	P. 146 - 147	P. 148 - 149	

■ Rugged Embedded ■ Machine Vision ■ In-vehicle Computing ■ Surveillance/Video Analytics ■ GPU Computing ■ IoT Gateway



Model Name	IGT-33V	IGT-34C	IGT-30D/31D	IGT-20/ 21/ 22
Chassis	Dimensions (W x D x H)	43 x 77 x 104 mm	43 x 77 x 104 mm	43 x 77 x 104 mm
	Weight	0.5kg	0.5kg	0.5kg
	Chassis Construction	Heavy duty metal	Heavy duty metal	Heavy duty metal
System	Processor	TI Sitara AM3352 1 GHz	TI Sitara AM3352 1 GHz	TI Sitara AM3352 1 GHz
	Chipset	-	-	-
	Graphics	-	-	-
	Memory	1GB DDR3L	1GB DDR3L	1GB DDR3L
I/O Interface	PoE	1 x PD port	1 x PD port	1 x PD port
	Ethernet	2 x 10/100M Ethernet	2 x 10/100M Ethernet	2 x 10/100M Ethernet
	Video Port	-	-	-
	Serial Port	1x RS-232/422/485 1x RS-485	1x RS-232/422/485 1x RS-485	1x RS-232/422/485
	USB 2.0	1	1	1
	UUSB 3.2/ USB 3.1	-	-	-
	Audio	-	-	-
	CAN bus	-	-	1 (IGT-31D Only)
	Analog I/O	8 x 16bit 0-10V / ±5V/ ±10V Voltage Input	4 x 16bit 4-20mA/ 0-20mA Current Input	-
	Digital I/O	2 DI + 6 DO	2 DI + 6 DO	8 DI + 2 DO
Storage Interface	SATA HDD	-	-	-
	mSATA	-	-	-
	CFast / MicroSD	2x MicroSD	2x MicroSD	2x MicroSD
	SIM	1	1	1
Expansion Bus	Mini PCI-E	1	1	1
	M.2	-	-	-
	MezIO®	-	-	-
	PCI/PCI Express	-	-	-
Power Supply	DC Input	12 to 25V DC	12 to 25V DC	12 to 25V DC
	Ignition Control	-	-	-
Environmental	Operating Temperature	-25°C ~ 70°C	-25°C ~ 70°C	-25°C ~ 70°C
	Certification	CE/ FCC	CE/ FCC	CE/ FCC
Released Date	2020/ 2	2020/ 2	2020/ 2	2017/ 3
Page Number	P. 92 - 93	P. 92 - 93	P. 94 - 95	P. 96 - 97



Model Name	SEMIL-1744GC	SEMIL-1724GC	SEMIL-1748GC	SEMIL-1728GC
Dimensions (W x D x H)	440 x 310 x 86.5 mm	440 x 310 x 86.5 mm	440 x 310 x 86.5 mm	440 x 310 x 86.5 mm
Weight	12 kg	12 kg	12.2 kg	12.2 kg
Chassis Construction	Aluminum alloy with stainless steel / waterproof	Aluminum alloy with stainless steel / waterproof	Aluminum alloy with stainless steel / waterproof	Aluminum alloy with stainless steel / waterproof
IP Rating	IP67	IP67	IP67	IP67
Processor	Intel® Xeon® E-2176G/ E-2278GE/ E-2278GEL Intel® Core™ i7-9700E/ i7-9700TE/ i7-8700/ i7-8700T Intel® Core™ i5-9500E/ i5-9500TE/ i5-8500/ i5-8500T Intel® Core™ i3-9100E/ i3-9100TE/ i3-8100/ i3-8100T	Intel® Xeon® E-2176G/ E-2278GE/ E-2278GEL Intel® Core™ i7-9700E/ i7-9700TE/ i7-8700/ i7-8700T Intel® Core™ i5-9500E/ i5-9500TE/ i5-8500/ i5-8500T Intel® Core™ i3-9100E/ i3-9100TE/ i3-8100/ i3-8100T	Intel® Xeon® E-2176G/ E-2278GE/ E-2278GEL Intel® Core™ i7-9700E/ i7-9700TE/ i7-8700/ i7-8700T Intel® Core™ i5-9500E/ i5-9500TE/ i5-8500/ i5-8500T Intel® Core™ i3-9100E/ i3-9100TE/ i3-8100/ i3-8100T	Intel® Xeon® E-2176G/ E-2278GE/ E-2278GEL Intel® Core™ i7-9700E/ i7-9700TE/ i7-8700/ i7-8700T Intel® Core™ i5-9500E/ i5-9500TE/ i5-8500/ i5-8500T Intel® Core™ i3-9100E/ i3-9100TE/ i3-8100/ i3-8100T
Acceleration GPU	NVIDIA® Tesla T4	NVIDIA® Quadro P2200	NVIDIA® Tesla T4	NVIDIA® Quadro P2200
Chipset	Intel® C246	Intel® C246	Intel® C246	Intel® C246
Graphics	Intel® UHD Graphics 630	Intel® UHD Graphics 630	Intel® UHD Graphics 630	Intel® UHD Graphics 630
Memory	Up to 64 GB DDR4-2666/ 2400	Up to 64 GB DDR4-2666/ 2400	Up to 64 GB DDR4-2666/ 2400	Up to 64 GB DDR4-2666/ 2400
PoE	1x IEEE 802.3at (25.5W) by Intel I219 (M12 X-coded) 3x IEEE 802.3at (25.5W) by Intel I210 (M12 X-coded)	1x IEEE 802.3at (25.5W) by Intel I219 (M12 X-coded) 3x IEEE 802.3at (25.5W) by Intel I210 (M12 X-coded)	1x IEEE 802.3at (25.5W) by Intel I219 (M12 X-coded) 7x IEEE 802.3at (25.5W) by Intel I210 (M12 X-coded)	1x IEEE 802.3at (25.5W) by Intel I219 (M12 X-coded) 7x IEEE 802.3at (25.5W) by Intel I210 (M12 X-coded)
10GbE Port	Optional 1x 10G port (M12 X-coded)	Optional 1x 10G port (M12 X-coded)	Optional 1x 10G port (M12 X-coded)	Optional 1x 10G port (M12 X-coded)
Video Port	1x VGA (M12 A-coded)	1x VGA (M12 A-coded)	1x VGA (M12 A-coded)	1x VGA (M12 A-coded)
Serial Port	2x RS-232 ports (M12 A-coded)	2x RS-232 ports (M12 A-coded)	2x RS-232 ports (M12 A-coded)	2x RS-232 ports (M12 A-coded)
USB 2.0	2x USB 2.0 (M12 A-coded) 1x USB 2.0 (internal)	2x USB 2.0 (M12 A-coded) 1x USB 2.0 (internal)	4x USB 2.0 (M12 A-coded) 1x USB 2.0 (internal)	4x USB 2.0 (M12 A-coded) 1x USB 2.0 (internal)
USB 3.2/ USB 3.1	-	-	-	-
Audio	-	-	1x mic-in and speaker-out (M12 A-coded)	1x mic-in and speaker-out (M12 A-coded)
Digital I/O	-	-	-	-
SATA HDD	2	2	2	2
mSATA	2	2	2	2
M.2 (M-key)	1	1	1	1
Mini PCI-E	2 (mux with mSATA)	2 (mux with mSATA)	4 (mux with mSATA)	4 (mux with mSATA)
M.2 (B-key/ E-Key)	-	-	-	-
SIM	2	2	2	2
MezIO®	-	-	-	-
PCI/PCI Express	1x PCIe with NVIDIA® Tesla T4 pre-installed	1x PCIe with NVIDIA® Quadro P2200 pre-installed	1x PCIe with NVIDIA® Tesla T4 pre-installed	1x PCIe with NVIDIA® Quadro P2200 pre-installed
DC Input	8 to 48V DC (M12 S-coded)	8 to 48V DC (M12 S-coded)	8 to 48V DC (M12 S-coded)	8 to 48V DC (M12 S-coded)
Ignition Control	Built-in	Built-in	Built-in	Built-in
Operating Temperature	with 35W CPU -25°C~ 70°C with >= 65W CPU -25°C~70°C (configured as 35W TDP mode) -25°C~ 50°C (configured as 65W TDP mode)	with 35W CPU -25°C~ 70°C with >= 65W CPU -25°C~70°C (configured as 35W TDP mode) -25°C~ 50°C (configured as 65W TDP mode)	with 35W CPU -25°C~ 70°C with >= 65W CPU -25°C~70°C (configured as 35W TDP mode) -25°C~ 50°C (configured as 65W TDP mode)	with 35W CPU -25°C~ 70°C with >= 65W CPU -25°C~70°C (configured as 35W TDP mode) -25°C~ 50°C (configured as 65W TDP mode)
Certification	EN 50155, CE/ FCC, MIL-STD-810G	EN 50155, CE/ FCC, MIL-STD-810G	EN 50155, CE/ FCC, MIL-STD-810G	EN 50155, CE/ FCC, MIL-STD-810G
Released Date	2021/ 7	2021/ 7	2021/ 7	2021/ 7
Page Number	P. 180 - 181	P. 180 - 181	P. 180 - 181	P. 180 - 181



Model Name	SEMIL-1704	SEMIL-1714J	SEMIL-1708	SEMIL-1718J
Dimensions (W x D x H)	220 x 310 x 86.5 mm	220 x 310 x 86.5 mm	220 x 310 x 86.5 mm	220 x 310 x 86.5 mm
Weight	5.8 kg	6 kg	5.8 kg	6 kg
Chassis Construction	Aluminum alloy with stainless steel	Aluminum alloy with stainless steel	Aluminum alloy with stainless steel	Aluminum alloy with stainless steel
IP Rating	IP67	IP67	IP67	IP67
Processor	Intel® Xeon® E-2176G/ E-2278GE/ E-2278GEL Intel® Core™ i7-9700E/ i7-9700TE/ i7-8700/ i7-8700T Intel® Core™ i5-9500E/ i5-9500TE/ i5-8500/ i5-8500T Intel® Core™ i3-9100E/ i3-9100TE/ i3-8100/ i3-8100T	Intel® Xeon® E-2176G/ E-2278GE/ E-2278GEL Intel® Core™ i7-9700E/ i7-9700TE/ i7-8700/ i7-8700T Intel® Core™ i5-9500E/ i5-9500TE/ i5-8500/ i5-8500T Intel® Core™ i3-9100E/ i3-9100TE/ i3-8100/ i3-8100T	Intel® Xeon® E-2176G/ E-2278GE/ E-2278GEL Intel® Core™ i7-9700E/ i7-9700TE/ i7-8700/ i7-8700T Intel® Core™ i5-9500E/ i5-9500TE/ i5-8500/ i5-8500T Intel® Core™ i3-9100E/ i3-9100TE/ i3-8100/ i3-8100T	Intel® Xeon® E-2176G/ E-2278GE/ E-2278GEL Intel® Core™ i7-9700E/ i7-9700TE/ i7-8700/ i7-8700T Intel® Core™ i5-9500E/ i5-9500TE/ i5-8500/ i5-8500T Intel® Core™ i3-9100E/ i3-9100TE/ i3-8100/ i3-8100T
Acceleration GPU	-	-	-	-
Chipset	Intel® C246	Intel® C246	Intel® C246	Intel® C246
Graphics	Intel® UHD Graphics 630	Intel® UHD Graphics 630	Intel® UHD Graphics 630	Intel® UHD Graphics 630
Memory	Up to 64 GB DDR4-2666/ 2400	Up to 64 GB DDR4-2666/ 2400	Up to 64 GB DDR4-2666/ 2400	Up to 64 GB DDR4-2666/ 2400
PoE	1x IEEE 802.3at (25.5W) by Intel I219 (M12 X-coded) 3x IEEE 802.3at (25.5W) by Intel I210 (M12 X-coded)	1x IEEE 802.3at (25.5W) by Intel I219 (M12 X-coded) 3x IEEE 802.3at (25.5W) by Intel I210 (M12 X-coded)	1x IEEE 802.3at (25.5W) by Intel I219 (M12 X-coded) 7x IEEE 802.3at (25.5W) by Intel I210 (M12 X-coded)	1x IEEE 802.3at (25.5W) by Intel I219 (M12 X-coded) 7x IEEE 802.3at (25.5W) by Intel I210 (M12 X-coded)
10GbE Port	Optional 1x 10G port (M12 X-coded)	Optional 1x 10G port (M12 X-coded)	Optional 1x 10G port (M12 X-coded)	Optional 1x 10G port (M12 X-coded)
Video Port	1x VGA (M12 A-coded)	1x VGA (M12 A-coded)	1x VGA (M12 A-coded)	1x VGA (M12 A-coded)
Serial Port	2x RS-232 ports (M12 A-coded)	2x RS-232 ports (M12 A-coded)	2x RS-232 ports (M12 A-coded)	2x RS-232 ports (M12 A-coded)
USB 2.0	2x USB 2.0 (M12 A-coded) 1x USB 2.0 (internal)	2x USB 2.0 (M12 A-coded) 1x USB 2.0 (internal)	4x USB 2.0 (M12 A-coded) 1x USB 2.0 (internal)	4x USB 2.0 (M12 A-coded) 1x USB 2.0 (internal)
USB 3.2/ USB 3.1	-	-	-	-
Audio	-	-	1x mic-in and speaker-out (M12 A-coded)	1x mic-in and speaker-out (M12 A-coded)
Digital I/O	-	-	-	-
SATA HDD	2	2	2	2
mSATA	2	2	2	2
M.2 (M-key)	1	1	1	1
Mini PCI-E	2 (mux with mSATA)	2 (mux with mSATA)	4 (mux with mSATA)	4 (mux with mSATA)
M.2 (B-key/ E-Key)	-	-	-	-
SIM	2	2	2	2
MezIO®	-	-	-	-
PCI/PCI Express	-	PB-2500J pre-installed	-	PB-2500J pre-installed
DC Input	8 to 48V DC (M12 S-coded)	8 to 48V DC (M12 S-coded)	8 to 48V DC (M12 S-coded)	8 to 48V DC (M12 S-coded)
Ignition Control	Built-in	Built-in	Built-in	Built-in
Operating Temperature	with 35W CPU -40°C~ 70°C with >= 65W CPU -40°C~70°C (configured as 35W TDP mode) -40°C~ 50°C (configured as 65W TDP mode)	with 35W CPU -40°C~ 70°C with >= 65W CPU -40°C~70°C (configured as 35W TDP mode) -40°C~ 50°C (configured as 65W TDP mode)	with 35W CPU -40°C~ 70°C with >= 65W CPU -40°C~70°C (configured as 35W TDP mode) -40°C~ 50°C (configured as 65W TDP mode)	with 35W CPU -40°C~ 70°C with >= 65W CPU -40°C~70°C (configured as 35W TDP mode) -40°C~ 50°C (configured as 65W TDP mode)
Certification	EN 50155, CE/ FCC, MIL-STD-810G	EN 50155, CE/ FCC, MIL-STD-810G	EN 50155, CE/ FCC, MIL-STD-810G	EN 50155, CE/ FCC, MIL-STD-810G
Released Date	2021/ 7	2021/ 7	2021/ 7	2021/ 7
Page Number	P. 182 - 183	P. 182 - 183	P. 182 - 183	P. 182 - 183

Selection Guide

SEMIL™



Model Name	SEMIL-1341GC	SEMIL-1321GC	SEMIL-1301	SEMIL-1311J	
Chassis	Dimensions (W x D x H)	440 x 310 x 86.5 mm	440 x 310 x 86.5 mm	220 x 310 x 86.5 mm	
	Weight	12 kg	12 kg	5.8 kg	
	Chassis Construction	Aluminum alloy with stainless steel	Aluminum alloy with stainless steel	Aluminum alloy with stainless steel	Aluminum alloy with stainless steel
	IP Rating	IP4X	IP4X	IP4X	IP4X
System	Processor	Intel® Xeon® E-2176G/ E-2278GE/ E-2278GEL Intel® Core™ i7-9700E/ i7-9700TE/ i7-8700/ i7-8700T Intel® Core™ i5-9500E/ i5-9500TE/ i5-8500/ i5-8500T Intel® Core™ i3-9100E/ i3-9100TE/ i3-8100/ i3-8100T	Intel® Xeon® E-2176G/ E-2278GE/ E-2278GEL Intel® Core™ i7-9700E/ i7-9700TE/ i7-8700/ i7-8700T Intel® Core™ i5-9500E/ i5-9500TE/ i5-8500/ i5-8500T Intel® Core™ i3-9100E/ i3-9100TE/ i3-8100/ i3-8100T	Intel® Xeon® E-2176G/ E-2278GE/ E-2278GEL Intel® Core™ i7-9700E/ i7-9700TE/ i7-8700/ i7-8700T Intel® Core™ i5-9500E/ i5-9500TE/ i5-8500/ i5-8500T Intel® Core™ i3-9100E/ i3-9100TE/ i3-8100/ i3-8100T	Intel® Xeon® E-2176G/ E-2278GE/ E-2278GEL Intel® Core™ i7-9700E/ i7-9700TE/ i7-8700/ i7-8700T Intel® Core™ i5-9500E/ i5-9500TE/ i5-8500/ i5-8500T Intel® Core™ i3-9100E/ i3-9100TE/ i3-8100/ i3-8100T
	Acceleration GPU	NVIDIA® Tesla T4	NVIDIA® Quadro P2200	-	-
	Chipset	Intel® C246	Intel® C246	Intel® C246	Intel® C246
	Graphics	Intel® UHD Graphics 630	Intel® UHD Graphics 630	Intel® UHD Graphics 630	Intel® UHD Graphics 630
	Memory	Up to 64 GB DDR4-2666/ 2400	Up to 64 GB DDR4-2666/ 2400	Up to 64 GB DDR4-2666/ 2400	Up to 64 GB DDR4-2666/ 2400
	PoE	1x IEEE 802.3at (25.5W) by Intel I219 (M12 X-coded) 3x IEEE 802.3at (25.5W) by Intel I210 (M12 X-coded)	1x IEEE 802.3at (25.5W) by Intel I219 (M12 X-coded) 3x IEEE 802.3at (25.5W) by Intel I210 (M12 X-coded)	1x IEEE 802.3at (25.5W) by Intel I219 (M12 X-coded) 3x IEEE 802.3at (25.5W) by Intel I210 (M12 X-coded)	1x IEEE 802.3at (25.5W) by Intel I219 (M12 X-coded) 3x IEEE 802.3at (25.5W) by Intel I210 (M12 X-coded)
	10GbE Port	Optional 1x 10G port (M12 X-coded)	Optional 1x 10G port (M12 X-coded)	Optional 1x 10G port (M12 X-coded)	Optional 1x 10G port (M12 X-coded)
Video Port	1x VGA (M12 A-coded) 1x DisplayPort	1x VGA (M12 A-coded) 1x DisplayPort	1x VGA (M12 A-coded) 1x DisplayPort	1x VGA (M12 A-coded) 1x DisplayPort	
Serial Port	2x RS-232 ports (M12 A-coded) 1x RS-232/422/485 1x RS-232	2x RS-232 ports (M12 A-coded) 1x RS-232/422/485 1x RS-232	2x RS-232 ports (M12 A-coded) 1x RS-232/422/485 1x RS-232	2x RS-232 ports (M12 A-coded) 1x RS-232/422/485 1x RS-232	
USB 2.0	2x USB 2.0 (M12 A-coded) 1x USB 2.0 (internal)	2x USB 2.0 (M12 A-coded) 1x USB 2.0 (internal)	2x USB 2.0 (M12 A-coded) 1x USB 2.0 (internal)	2x USB 2.0 (M12 A-coded) 1x USB 2.0 (internal)	
USB 3.2/ USB 3.1	3	3	3	3	
Audio	1x mic-in and speaker-out	1x mic-in and speaker-out	1x mic-in and speaker-out	1x mic-in and speaker-out	
Digital I/O	-	-	-	-	
SATA HDD	2	2	2	2	
Storage Interface	mSATA	2	2	2	
	M.2 (M-key)	1	1	1	
	Mini PCI-E	2 (mux with mSATA)	2 (mux with mSATA)	2 (mux with mSATA)	2 (mux with mSATA)
Expansion Bus	M.2 (B-key/ E-Key)	1x M.2 B-key 1x M.2 E-key	1x M.2 B-key 1x M.2 E-key	1x M.2 B-key 1x M.2 E-key	
	SIM	4	4	4	4
	MezIO®	-	-	-	-
PCI/PCI Express	1x PCIe with NVIDIA® Tesla T4 pre-installed	1x PCIe with NVIDIA® Quadro P2200 pre-installed	-	PB-2500J pre-installed	
Power Supply	DC Input	8 to 48V DC	8 to 48V DC	8 to 48V DC	
	Ignition Control	Built-in	Built-in	Built-in	
Environmental	Operating Temperature	with 35W CPU -25°C ~ 70°C with ≥ 65W CPU -25°C ~ 70°C (configured as 35W TDP mode) -25°C ~ 50°C (configured as 65W TDP mode)	with 35W CPU -25°C ~ 70°C with ≥ 65W CPU -25°C ~ 70°C (configured as 35W TDP mode) -25°C ~ 50°C (configured as 65W TDP mode)	with 35W CPU -40°C ~ 70°C with ≥ 65W CPU -40°C ~ 70°C (configured as 35W TDP mode) -40°C ~ 50°C (configured as 65W TDP mode)	with 35W CPU -40°C ~ 70°C with ≥ 65W CPU -40°C ~ 70°C (configured as 35W TDP mode) -40°C ~ 50°C (configured as 65W TDP mode)
	Certification	EN 50155, CE/ FCC, MIL-STD-810G	EN 50155, CE/ FCC, MIL-STD-810G	EN 50155, CE/ FCC, MIL-STD-810G	EN 50155, CE/ FCC, MIL-STD-810G
Released Date	2021/ 7	2021/ 7	2021/ 7	2021/ 7	
Page Number	P. 184 - 185	P. 184 - 185	P. 186 - 187	P. 186 - 187	



Neousys Intelligent Embedded Systems

- ▮ Rugged Embedded
- ▮ Machine Vision
- ▮ IoT Gateway
- ▮ In-vehicle Computing
- ▮ Surveillance/ Video Analytics
- ▮ Edge AI Computing
- ▮ SEMIL



Rugged Embedded



Nuvo-9000 Series

Intel® 13th/12th-Gen Core™ Rugged Embedded Computer with 6x 2.5GbE/ GbE, USB 3.2 Type-C, Patented Cassette & MeziO® Interface

Key Features

- Supports Intel® 13th/12th-Gen Core™ 24C/ 32T 35W/ 65W CPU
- Patented Cassette for PCI/PCIe add-on card accommodation
- Rugged, -25°C to 70°C fanless operation
- Up to 5x 2.5GbE and 1x GigE ports with optional PoE+, supporting 9.5 KB jumbo frame
- 1x USB 3.2 Gen2x2 type-C and 8x USB 3.2/ 2.0 type-A ports
- Supports M.2 Gen4x4 NVMe and 2x SATA ports
- MeziO® interface for easy function expansion
- VGA/ DVI/ DP triple independent display, supporting 4K2K resolution

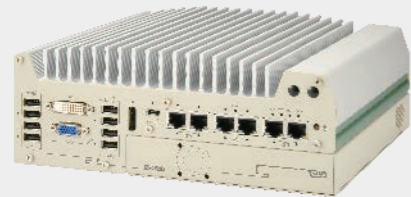

*R.O.C Patent No. M456527

Introduction

Nuvo-9000 series is Neosys' new rugged embedded computer based on Intel® 13th/12th-Gen platform. Benefiting from cutting-edge Intel® 7 photolithography, the latest Core™ desktop processor comes with up to 24 cores and 32 threads and presents an incredible boost of computational performance. Combining the increase of DDR5 memory bandwidth and PCIe Gen4 NVMe high-speed disk read/write, users can expect an overall system performance improvement of up to 2x when compared to previous 10th or 11th- Gen platforms.

Nuvo-9000 series inherits Neosys' patented expansion Cassette design to provide great versatility by allowing additional installation of PCIe or PCI add-on cards. There are three expansion Cassette options available for Nuvo-9000 series, the Nuvo-9000E features a single x16 Gen3 PCIe slot; Nuvo-9000DE has dual x16 PCIe slots, and Nuvo-9000P has a single PCI slot. For users who need more flexible storage, Nuvo-9000LP has a 2.5" HDD tray instead of an expansion Cassette to support a hot-swappable 2.5" HDD/SSD.

I/O functions are also comprehensively enhanced. In addition to six 2.5G and Gigabit Ethernet ports with PoE+ PSE option, Nuvo-9000 series features a USB 3.2 Gen2x2 type-C port offering 20 Gbps bandwidth for data exchange with external devices, plus another six USB 3.2 type-A ports for USB3 camera connectivity. It also has an upgraded M.2 Gen4x4 slot to support the latest NVMe SSD to boost disk read/write speed up to 7000 MB/s. For unfulfilled I/O requirements, users can utilize the expansion Cassette to add on function-specific PCIe/ PCI card, the proprietary MeziO® interface, and internal mini-PCIe/M.2 interfaces.

With its field-proven thermal design, significant CPU and I/O upgrades, and multiple expansion methods, the Neosys Nuvo-9000 series fits your need for ruggedness, performance, and versatility for a variety of applications.

Specifications

System Core		Internal Expansion Bus		
Processor	Supporting Intel® 13th-Gen Core™ CPU (LGA1700 socket, 65W/ 35W TDP)	PCI/PCI Express	1x PCIe x16 slot@Gen3, 8-lanes PCIe signals in Cassette (Nuvo-9002E/ 9006E)	
	- Intel® Core™ i9-13900E/ i9-13900TE		2x PCIe x16 slots@Gen3, 8-lanes PCIe signals in Cassette (Nuvo-9002DE/ 9006DE)	
	- Intel® Core™ i7-13700E/ i7-13700TE		1x PCI slot in Cassette (Nuvo-9002P/ 9006P)	
	- Intel® Core™ i5-13500E/ i5-13400E/ i5-13500TE		Mini PCI Express	1x full-size mini PCI Express socket
- Intel® Core™ i3-13100E/ i3-13100TE	Supporting Intel® 12th-Gen Core™ CPU (LGA1700 socket, 65W/ 35W TDP)	M.2	1x M.2 2242/3052 B key socket with SIM slot for M.2 5G/ 4G module	
Chipset	Intel® Q670E platform controller hub	Expandable I/O	1x MeziO® expansion port for Neosys MeziO® modules	
	Integrated Intel® UHD Graphics 770 (32EU) / 730 (24EU)	Power Supply	DC Input	1x 3-pin pluggable terminal block for 8 to 48V DC input
Graphics	Integrated Intel® UHD Graphics 770 (32EU) / 730 (24EU)	Remote Ctrl. & LED Output	1x 3-pin pluggable terminal block for remote control and PWR LED output (Ctrl_In/ GND/ LED_Out)	
Memory	Up to 64 GB DDR5 4800 SDRAM (two SODIMM slots)	Mechanical	Dimension	240 mm (W) x 225 mm (D) x 90 mm (H) (Nuvo-9000E/ P series) 240 mm (W) x 225 mm (D) x 110.5 mm (H) (Nuvo-9000DE series) 240 mm (W) x 225 mm (D) x 79 mm (H) (Nuvo-9000LP series)
AMT	Supports Intel® vPro/ AMT 16.0	Weight	Weight	3.58 kg (Nuvo-9000E/ P series)/ 3.89 kg (Nuvo-9000DE series) 3.36 kg (Nuvo-9000LP series)
TPM	Supports dTPM 2.0	Mounting	Mounting	Wall-mount (standard) or DIN-rail mount (optional)
I/O Interface		Environmental	Operating Temperature	with 35W CPU -25°C ~ 70°C ** with 65W CPU -25°C ~ 70°C **/**** (configured as 35W TDP) -25°C ~ 50°C **/**** (configured as 65W TDP)
Ethernet port*	1x 2.5G Ethernet by I225-IT and 1x Gigabit Ethernet by I219-LM (Nuvo-9002E/ P/ DE/ LP) with screw-lock	Storage Temperature	Storage Temperature	-40°C ~ 85°C
	5x 2.5G Ethernet by I225-IT and 1x Gigabit Ethernet by I219-LM (Nuvo-9006E/ P/ DE/ LP) with screw-lock		Humidity	10%~90% , non-condensing
PoE+	Optional IEEE 802.3at PoE+ PSE for Port 3 ~ Port 6 (2.5GbE) 100 W total power budget	Vibration	Vibration	MIL-STD-810H, Method 514.8, Category 4
USB 3.2	1x USB 3.2 Gen2x2 (20 Gbps) port in type-C connector with screw-lock	Shock	Shock	MIL-STD-810H, Method 516.8, Procedure I
	4x USB 3.2 Gen2x1 (10 Gbps) ports in type-A connectors		EMC	CE/FCC Class A, according to EN 55032 & EN 55035
USB 2.0	2x USB 3.2 Gen1x1 (5 Gbps) ports in type-A connectors	SATA HDD	M.2 NVMe	1x M.2 2280 M key NVMe socket (PCIe Gen4x4) for NVMe SSD
	2x USB 2.0 ports			2x internal SATA port for 2.5" HDD/ SSD installation, supporting RAID 0/ 1 (Nuvo-9000E/ 9000P/ 9000DE)
Video Port (Integrated Graphics)	1x VGA, supporting 1920 x 1200 resolution	Footnote		* Due to I225-IT specification limitation, for systems running 2.5G Ethernet link speeds, please limit the operating temperature to 60°C. ** For sub-zero operating temperature, a wide temperature HDD or Solid State Disk (SSD) is required. *** For CPU operating at 65W mode, the highest operating temperature shall be limited to 50°C and thermal throttling may occur when sustained full-loading applied. Users can configure CPU power in BIOS to allow higher operating temperature.
	1x DVI-D, supporting 1920 x 1200 resolution			
Serial Port	1x DisplayPort, supporting 4096 x 2304 resolution			
	2x software-programmable RS-232/ 422/ 485 ports (COM1/ COM2)			
Audio	2x RS-232 ports (COM3/ COM4)			
	1x 3.5 mm jack for mic-in and speaker-out			

Appearance

Nuvo-9000E/P

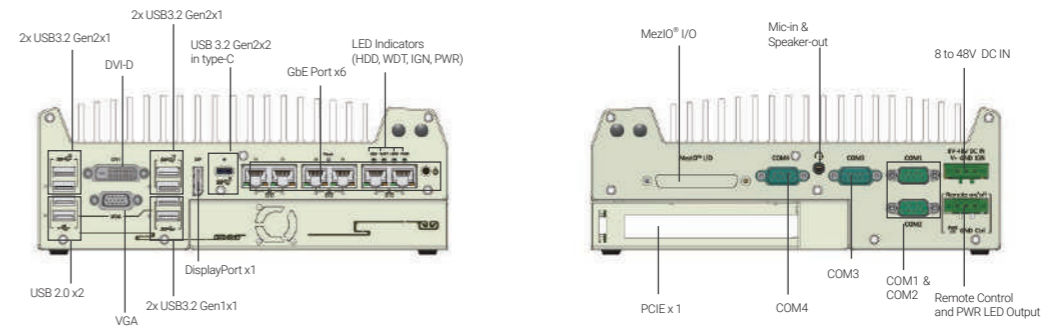

Dimensions

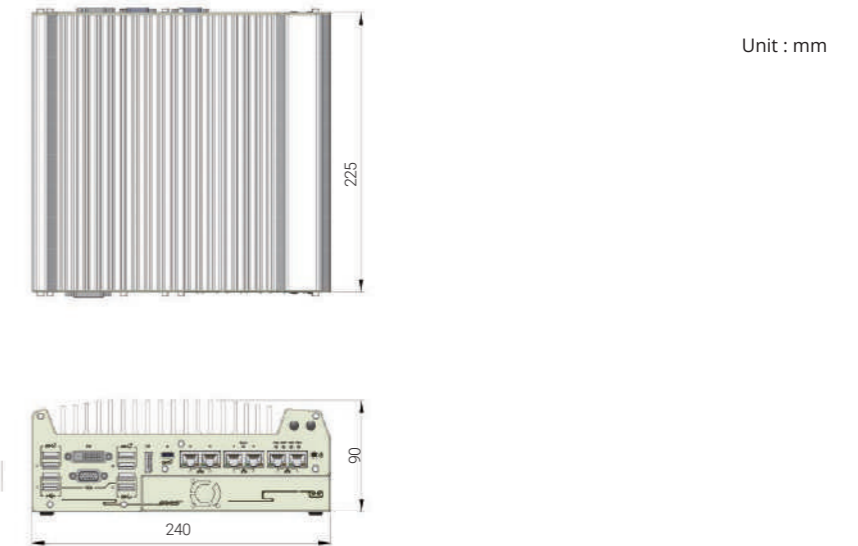

Unit : mm

Ordering Information

Model No.	Product Description
Nuvo-9002E	Intel® 13 th /12 th -Gen Core™ Rugged Embedded Computer with 2x 2.5GbE/ GbE, USB 3.2 Type-C, single-slot PCIe Cassette & MeziO® Interface
Nuvo-9002P	Intel® 13 th /12 th -Gen Core™ Rugged Embedded Computer with 2x 2.5GbE/ GbE, USB 3.2 Type-C, single-slot PCI Cassette & MeziO® Interface
Nuvo-9006E	Intel® 13 th /12 th -Gen Core™ Rugged Embedded Computer with 6x 2.5GbE/ GbE, USB 3.2 Type-C, single-slot PCIe Cassette & MeziO® Interface
Nuvo-9006P	Intel® 13 th /12 th -Gen Core™ Rugged Embedded Computer with 6x 2.5GbE/ GbE, USB 3.2 Type-C, single-slot PCI Cassette & MeziO® Interface
PoE+ Option	Option of 802.3at PoE+ PSE for 2.5GbE port 3 ~ port 6

Optional Accessories

DINRAIL-O	DIN-rail mount assembly for Nuvo-9000 series
Dmpbr-Nuvo5000_7000	Neosys' patented damping brackets assembly for Nuvo-9000 Series
Fankit-25	Fan assembly for 1-slot Cassette, 25x25x10 mm
PA-160W-OW	160W AC-DC power adapter 20V/8A; 18AWG/120cm; cord end terminals for terminal block, operating temperature: -30°C to 70°C. (recommended for 35W CPU)
PA-280W-ET2	280W AC/DC power adapter 24V/ 11.67A; 16AWG/ 100cm; cord end terminals for terminal block, operating temperature : -30°C to 60°C. (recommended for 65W CPU or 35W CPU with PoE+ option)
MeziO® Modules	
MeziO®-C180	MeziO® module with 4x RS-232/ 422/ 485 ports and 4x RS-232 ports
MeziO®-C181	MeziO® module with 4x RS-232/ 422/ 485 ports and 4x RS-422/ 485 ports
MeziO®-D220	MeziO® module with 8-CH isolated digital input and 8-CH isolated digital output
MeziO®-D230	MeziO® module with 16-CH isolated digital input and 16-CH isolated digital output
MeziO®-V20-EP	MeziO® module with ignition power control function for in-vehicle application
MeziO®-U4	MeziO® module with 4x USB 3.1 ports
MeziO®-G4	MeziO® module with 4x GigE ports
MeziO®-G4P	MeziO® module with 4x IEEE 802.3at PoE+ ports

Only Nuvo-9006E-PoE and Nuvo-9006P-PoE support MeziO-G4P

Appearance

Nuvo-9000DE

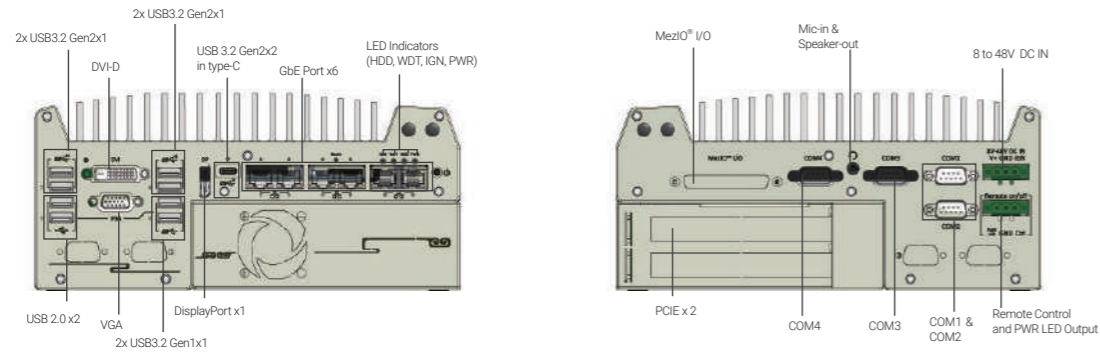

Dimensions

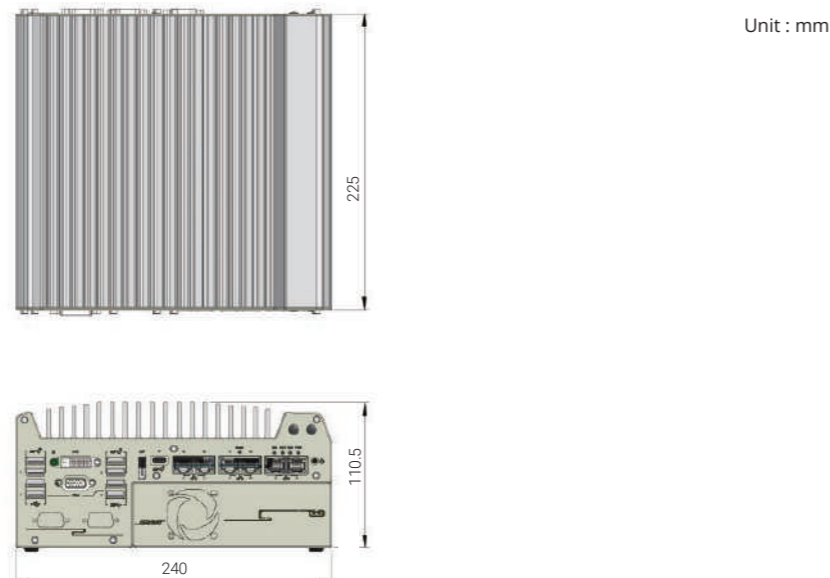

Ordering Information

Model No.	Product Description
Nuvo-9002DE	Intel® 13th/12th -Gen Core™ Rugged Embedded Computer with 2x 2.5GbE/ GbE, USB 3.2 Type-C, dual-slot PCIe Cassette & MeziO® Interface
Nuvo-9006DE	Intel® 13th/12th -Gen Core™ Rugged Embedded Computer with 6x 2.5GbE/ GbE, USB 3.2 Type-C, dual-slot PCIe Cassette & MeziO® Interface
PoE+ Option	Option of 802.3at PoE+ PSE for 2.5GbE port 3 ~ port 6

Optional Accessories

DINRAIL-O	DIN-rail mount assembly for Nuvo-9000 series
Dmpbr-Nuvo5000_7000	Neosys' patented damping brackets assembly for Nuvo-9000 Series
PA-160W-OW	160W AC-DC power adapter 20V/8A; 18AWG/120cm; cord end terminals for terminal block, operating temperature: -30°C to 70°C. (recommended for 35W CPU)
PA-280W-ET2	280W AC/DC power adapter 24V/ 11.67A ; 16AWG/ 100cm; cord end terminals for terminal block, operating temperature : -30°C to 60°C. (recommended for 65W CPU or 35W CPU with PoE+ option)
MeziO® Modules	
MeziO®-C180	MeziO® module with 4x RS-232/ 422/ 485 ports and 4x RS-232 ports
MeziO®-C181	MeziO® module with 4x RS-232/ 422/ 485 ports and 4x RS-422/ 485 ports
MeziO®-D220	MeziO® module with 8-CH isolated digital input and 8-CH isolated digital output
MeziO®-D230	MeziO® module with 16-CH isolated digital input and 16-CH isolated digital output
MeziO®-V20-EP	MeziO® module with ignition power control function for in-vehicle application
MeziO®-U4	MeziO® module with 4x USB 3.1 ports
MeziO®-G4	MeziO® module with 4x GigE ports
MeziO®-G4P	MeziO® module with 4x IEEE 802.3at PoE+ ports

Only Nuvo-9006DE-PoE support MeziO-G4P

Appearance

Nuvo-9000LP

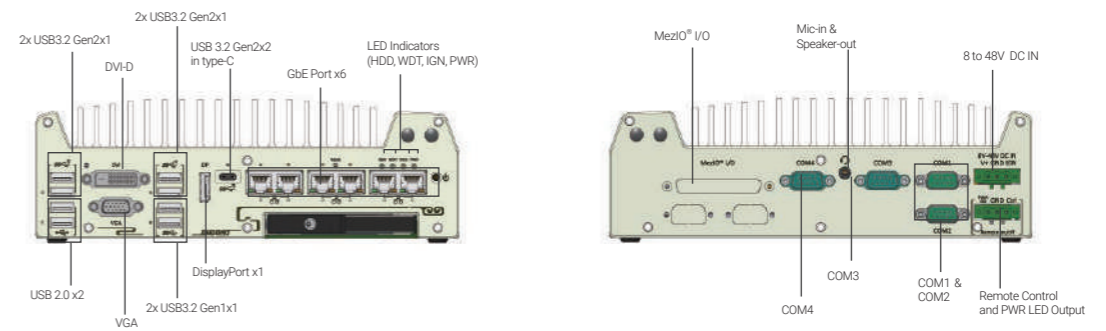

Dimensions

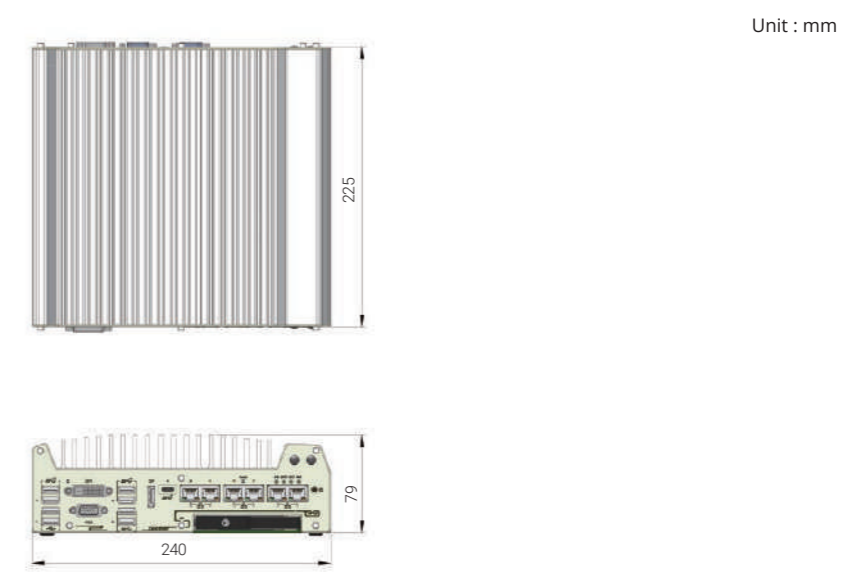

Ordering Information

Model No.	Product Description
Nuvo-9002LP	Intel® 13th/12th-Gen Core™ Rugged Embedded Computer with 2x 2.5GbE/ GbE, USB 3.2 Type-C, MeziO® Interface & 2.5" HDD tray
Nuvo-9006LP	Intel® 13th/12th-Gen Core™ Rugged Embedded Computer with 6x 2.5GbE/ GbE, USB 3.2 Type-C, MeziO® Interface & 2.5" HDD tray
PoE+ Option	Option of 802.3at PoE+ PSE for 2.5GbE port 3 ~ port 6

Optional Accessories

DINRAIL-O	DIN-rail mount assembly for Nuvo-9000 series
Dmpbr-Nuvo5000_7000	Neosys' patented damping brackets assembly for Nuvo-9000 Series
PA-160W-OW	160W AC-DC power adapter 20V/8A; 18AWG/120cm; cord end terminals for terminal block, operating temperature: -30°C to 70°C. (recommended for 35W CPU)
PA-280W-ET2	280W AC/DC power adapter 24V/ 11.67A ; 16AWG/ 100cm; cord end terminals for terminal block, operating temperature : -30°C to 60°C. (recommended for 65W CPU or 35W CPU with PoE+ option)
MeziO® Modules	
MeziO®-C180	MeziO® module with 4x RS-232/ 422/ 485 ports and 4x RS-232 ports
MeziO®-C181	MeziO® module with 4x RS-232/ 422/ 485 ports and 4x RS-422/ 485 ports
MeziO®-D220	MeziO® module with 8-CH isolated digital input and 8-CH isolated digital output
MeziO®-D230	MeziO® module with 16-CH isolated digital input and 16-CH isolated digital output
MeziO®-V20-EP	MeziO® module with ignition power control function for in-vehicle application
MeziO®-U4	MeziO® module with 4x USB 3.1 ports
MeziO®-G4	MeziO® module with 4x GigE ports
MeziO®-G4P	MeziO® module with 4x IEEE 802.3at PoE+ ports

Only Nuvo-9006LP-PoE support MeziO-G4P

Nuvo-9531 Series

Intel® 13th/12th-Gen Core™ i9/ i7/ i5/ i3 Compact Fanless Computer with 4x 2.5GbE, 4x USB3.2 and 1x Hot-swappable HDD Tray

Key Features

- 212 x 165 x 63 mm low-profile design
- Intel® 13th/12th-Gen Core™ 35W/ 65W LGA1700 CPU
- Rugged, -25°C to 60°C fanless operation
- 4x 2.5GbE with optional PoE+ and 4x USB3.2 Gen 1 with screw-lock
- M.2 2280 Gen4x4 NVMe and 1x hot-swappable HDD tray for storage
- 4-CH isolated DI and 4-CH isolated DO
- VGA + DP dual display outputs
- Optional ignition power control



Introduction

Nuvo-9531 is one of the most compact fanless embedded computers based on the Intel® 13th/12th-Gen platform. Measuring just 212 x 165 x 63 mm, it can fit into restricted spaces, such as in robotic arm and AMR applications. Despite its compact size, Nuvo-9531 does not compromise on performance. Built on the advanced Intel® 7 process, Intel® 13th-Gen processors have up to 24 cores/ 32 threads to deliver up to 2x the performance when compared to previous Intel® 10th or 11th-Gen platforms. Nuvo-9531 is a compact fanless embedded computer that offers the ultimate computing for various industrial applications.

Nuvo-9531 has rich I/O functions. It features four 2.5GbE with optional PoE+ PSE and four USB3.2 Gen1 ports for multiple camera connectivity for machine vision and surveillance applications. In addition, it features a Gen4 x4 M.2 NVMe slot for the latest NVMe SSD that supports read/ write speeds up to 7000 MB/s; a hot-swappable HDD tray to hot-swap the storage drive without turning off the system or dismantling the chassis; two mPCIe and one M.2 E key slots to install WiFi or 5G/ 4G wireless communication modules. The system is also equipped with 8x DIO, 2x COM ports, and dual display outputs for your industrial embedded application needs.

As a compact embedded computer, Nuvo-9531 delivers excellent computing performance and offers an abundance of I/O connections. It is suitable for a variety of industrial applications, especially when installation space is limited.

Specifications

System Core		Internal Expansion Bus	
Processor	Supporting Intel® 13th-Gen Core™ CPU (LGA1700 socket, 65W/ 35W TDP)	Supporting Intel® 12th-Gen Core™ CPU (LGA1700 socket, 65W/ 35W TDP)	Mini PCI Express 2x full-size mini PCI Express sockets with internal SIM sockets
	- Intel® Core™ i9-13900E/ i9-13900TE	- Intel® Core™ i9-12900E/ i9-12900TE	M.2 E key 1x M.2 2230 E key socket for WiFi5, WiFi6 or Google edge TPU module
	- Intel® Core™ i7-13700E/ i7-13700TE	- Intel® Core™ i7-12700E/ i7-12700TE	Storage Interface
	- Intel® Core™ i5-13500E/ i5-13500TE	- Intel® Core™ i5-12500E/ i5-12500TE	SATA HDD 1x hot-swappable 2.5" HDD/ SSD tray for 7mm HDD/ SSD
- Intel® Core™ i3-13100E/ i3-13100TE	- Intel® Pentium® G7400E/ G7400TE	- Intel® Celeron® G6900E/ G6900TE	M.2 1x M.2 2280 M key socket (PCIe Gen4 x4) for NVMe SSD
Chipset	Intel® H610E platform controller hub		Power Supply
Graphics	Integrated Intel® UHD Graphics 770 (32EU) / 730 (24EU)		DC Input 1x 3-pin pluggable terminal block for 8 to 48V DC input with optional ignition power control
Memory	Up to 32GB non-ECC DDR4 3200 SDRAM (one SODIMM slot)		Mechanical
TPM	Supports dTPM 2.0		Dimension 212mm (W) x 165 mm (D) x 63 mm (H)
I/O Interface			Weight 2.5 kg
Ethernet	4x 2.5GBASE-T Ethernet ports by Intel® I226-IT GbE controllers		Mounting Wall-mount (standard) or DIN-rail mount (optional)
PoE+	Optional IEEE 802.3at PoE+ PSE for 4x2.5GbE ports 100 W total power budget		Environmental
USB 3.2	4x USB 3.2 Gen1 (5 Gbps) ports		Operating Temperature with 35W CPU -25°C ~ 60°C * with 65W CPU (installation of the optional fan kit is recommended) -25°C ~ 60°C **
USB 2.0	2x USB 2.0 ports		Storage Temperature -40°C ~ 85°C
Video Port (Integrated Graphics)	1x VGA output, supporting 1920 x 1200 resolution 1x DisplayPort, supporting 4096 x 2304 resolution		Humidity 10%~90% , non-condensing
Serial Port	1x software-programmable RS-232/422/485 ports (COM1) 3x 3-wire RS-232 ports (COM2/3/4) or 1x RS-422/485 port (COM2)		Vibration MIL-STD-810H, Method 514.8, Category 4
Audio	1x 3.5 mm jack for mic-in and speaker-out		Shock MIL-STD-810H, Method 516.8, Procedure I
Isolated DIO	4-CH isolated DI and 4-CH isolated DO		EMC CE/FCC Class A, according to EN 55032 & EN 55035

* For sub-zero operating temperature, a wide temperature HDD or Solid State Disk (SSD) is required.
** For 65W CPUs, the optional fan kit is recommended for operating at ambient temperatures higher than 50°C.

Appearance

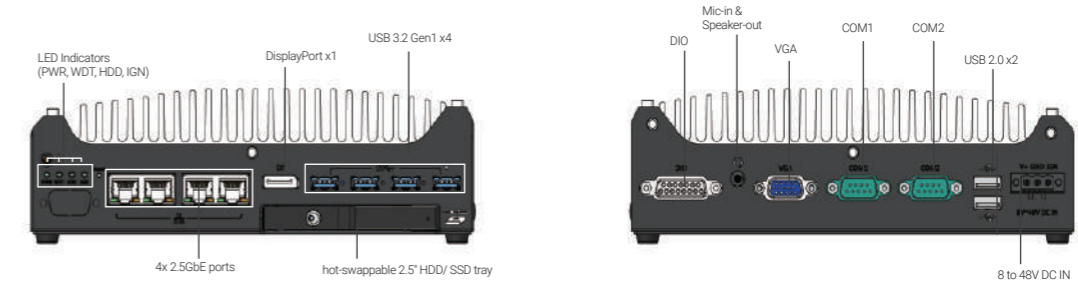

Dimensions

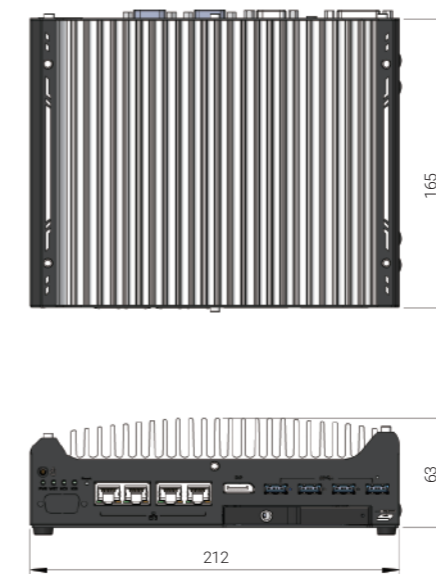

Unit : mm

Ordering Information

Model No.	Product Description
Nuvo-9531	Intel® 13 th /12 th -Gen Core™ i9/ i7/ i5/ i3 compact fanless computer with 4x 2.5GbE, 4x USB3.2 Gen 1 and a hot-swappable HDD tray
	Optional 802.3at PoE+ PSE for 4x 2.5GbE ports
	Optional ignition power control

Optional Accessories

PA-160W-OW	160W AC-DC power adapter 20V/8A; 18AWG/120cm; cord end terminals for terminal block, operating temperature: -30°C to 70°C.
PA-280W-ET2	280W AC/DC power adapter 24V/ 11.67A ; 16AWG/ 100cm; cord end terminals for terminal block, operating temperature : -30°C to 60°C.
DINRAIL-31	DIN-rail mounting assembly for Nuvo-9531 series
AccsyBx-FAN-Nuvo9531_9501	Fan kit with 92mm x 92mm fan for Nuvo-9531/ Nuvo-9501 series

Nuvo-9501 Series

Intel® 13th/12th-Gen Core™ Compact Fanless Computer with 2x 2.5GbE and 4x USB3.2



Key Features

- Intel® 13th/12th-Gen Core™ 35W/ 65W LGA1700 CPU
- Compact 212 x 165 x 80 mm footprint
- Rugged, -25°C to 60°C fanless operation (Nuvo-9505D only)
- Up to 32GB DDR4 3200 SODIMM
- 2x 2.5GbE and 4x USB3.2 Gen 1 with screw-lock
- Supports 1x M.2 2280 Gen4 x4 NVMe and 1x 3.5"/2.5" SATA HDD/SSD storage
- 4-CH isolated DI and 4-CH isolated DO (Nuvo-9505D only)
- VGA + DP dual display outputs



Introduction

Nuvo-9501 is a cost-effective compact fanless embedded computer based on the Intel® 13th/12th-Gen platform. Built on the advanced Intel® 7 process, Intel® 13th Gen processors offer up to 24 cores/ 32 threads to deliver up to 2x the performance when compared to previous Intel® 10th or 11th-Gen platforms. Nuvo-9501 is a cost-effective, compact and yet powerful fanless embedded computer that offers the ultimate computing for various industrial applications.

Nuvo-9501 offers essential I/O functions for general industrial needs including dual 2.5GbE ports, dual display ports and four USB3.2 ports. In addition, it features a Gen4 x4 M.2 NVMe slot for the latest NVMe SSD with read/ write speeds up to 7000 MB/s. Also, it supports a 2.5" or 3.5" HDD for high capacity storage needs such as data collection or surveillance applications. It also offers two mPCIe and one M.2 E key slots for installing WiFi or 5G/ 4G wireless communication modules.

As a cost-effective and compact embedded computer, Nuvo-9501 delivers excellent computing performance and offers essential I/O connectivity to meet customers' needs and cost. It is suitable for a variety of industrial applications.

Specifications

System Core		Storage Interface
Processor	Supporting Intel® 13 th -Gen Core™ CPU (LGA1700 socket, 65W/ 35W TDP)	SATA HDD
	Supporting Intel® 12 th -Gen Core™ CPU (LGA1700 socket, 65W/ 35W TDP)	1x internal SATA port for 3.5" HDD or 2.5" HDD/ SSD
Chipset	- Intel® Core™ i9-13900E/ i9-13900TE	M.2
	- Intel® Core™ i7-13700E/ i7-13700TE	1x M.2 2280 M key socket (PCIe Gen4 x4) for NVMe SSD
Graphics	- Intel® Core™ i5-13500E/ i5-13400E/ i5-13500TE	Power Supply
	- Intel® Core™ i3-13100E/ i3-13100TE	DC Input
Memory	- Intel® Pentium® G7400E/ G7400TE	1x 3-pin pluggable terminal block for 8-35V DC input with remote on/off control
	- Intel® Celeron® G6900E/ G6900TE	Mechanical
TPM	Supports fTPM 2.0	Dimension
		212mm (W) x 165 mm (D) x 80 mm (H)
I/O Interface		Weight
		2.5 kg
Ethernet	2x 2.5GBASE-T Ethernet ports by Intel® I226-V GbE controllers (Nuvo-9501)	Mounting
	2x 2.5GBASE-T Ethernet ports by Intel® I226-IT GbE controllers (Nuvo-9505D)	Wall-mount (optional) or DIN-rail mount (optional)
USB 3.2	4x USB 3.2 Gen1 (5 Gbps) ports	Environmental
	2x USB 2.0 ports	Operating Temperature
Video Port (Integrated Graphics)	1x VGA output, supporting 1920 x 1200 resolution	With 35W CPU
	1x DisplayPort, supporting 4096 x 2304 resolution	-10°C to 60°C * (Nuvo-9501)
Serial Port	1x software-programmable RS-232/422/485 ports (COM1)	-25°C to 60°C * (Nuvo-9505D)
	3x 3-wire RS-232 ports (COM2/3/4) or 1x RS-422/485 port (COM2)	With 65W CPU (installation of the optional fan kit is recommended)
Audio	1x 3.5 mm jack for mic-in and speaker-out	-10°C to 60°C */** (Nuvo-9501)
		-25°C to 60°C */** (Nuvo-9505D)
Isolated DIO	4-CH isolated DI and 4-CH isolated DO (Nuvo-9505D only)	Storage Temperature
		-40°C ~ 85°C
Internal Expansion Bus		Humidity
	Mini PCI Express	10%~90% , non-condensing
M.2 E key	2x full-size mini PCI Express sockets with internal SIM sockets	Vibration
	1x M.2 2230 E key socket for WiFi5, WiFi6 or Google Edge TPU module	MIL-STD-810H, Method 514.8, Category 4
		Shock
		MIL-STD-810H, Method 516.8, Procedure I
		EMC
		CE/FCC Class A, according to EN 55032 & EN 55035

* For sub-zero operating temperature, a wide temperature HDD or Solid State Disk (SSD) is required.
 ** For 65W CPUs, the optional fan kit is recommended for operating at ambient temperatures higher than 50°C.

Appearance



Dimensions

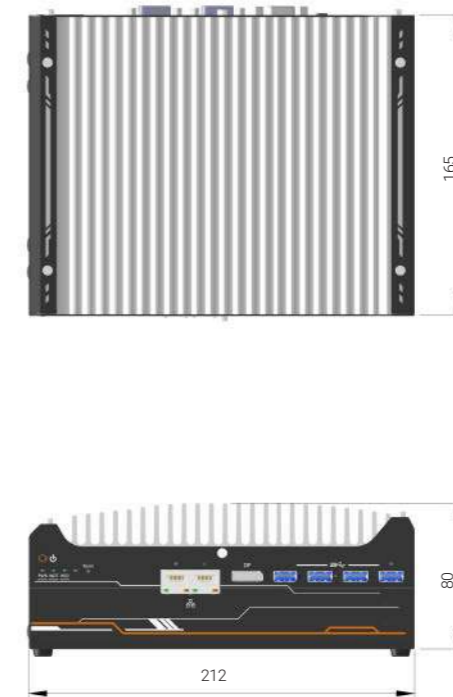

Unit : mm

Ordering Information

Model No.	Product Description
Nuvo-9501	Intel® 13 th /12 th -Gen Core™ compact fanless computer with 2x 2.5GbE and 4x USB3.2
Nuvo-9505D	Intel® 13 th /12 th -Gen Core™ compact fanless computer with 2x 2.5GbE, 4x USB3.2 and 8x isolated DIO

Optional Accessories

PA-160W-OW	160W AC-DC power adapter 20V/8A; 18AWG/120cm; cord end terminals for terminal block, operating temperature: -30°C to 70°C. (recommended for 35W CPU)
PA-280W-ET2	280W AC/DC power adapter 24V/ 11.67A ; 16AWG/100cm; cord end terminals for terminal block, operating temperature: -30°C to 60°C. (recommended for 65W CPU)
Wmkit-Nuvo9501	Wall mount assembly for Nuvo-9501 series
DINRAIL-31	DIN-rail mounting assembly for Nuvo-9501 series
AccsyBx-FAN-Nuvo9531_9501	Fan kit with 92mm x 92mm fan for Nuvo-9501/ Nuvo-9531 series

Nuvo-7000E/P/DE Series

Intel® 9th/ 8th-Gen Core™ i7/ i5/ i3 Fanless Controller with 6x GbE Ports, Patented Cassette and MezIO® Interface



Key Features

- Intel® 9th/ 8th-Gen Core™ i hexa-core 35W/ 65W LGA1151 CPU
- Patented Cassette for PCI/PCIe add-on card accommodation*
- MezIO® interface for easy function expansion
- Rugged, -25°C to 70°C fanless operation
- Up to 6x GigE ports, supporting 9.5 KB jumbo frame
- M.2 2280 M key socket (Gen3 x4) supporting NVMe SSD or Intel® Optane™ memory
- 4x USB 3.1 Gen2 ports and 4x USB 3.1 Gen1 ports
- VGA/ DVI/ DP triple independent display, supporting 4K2K resolution



*R.O.C Patent No. M456527

Introduction

The Neosys Nuvo-7000 series is powered by Intel® 9th/ 8th-Gen Core™ i processors with up to 6-core/ 8-core architecture that offer significant performance improvement over previous 6th and 7th-Gen platforms.

Nuvo-7000 series includes Neosys' track-proven technologies for superior ruggedness and versatility, such as effective fanless design, patented expansion Cassette and proprietary MezIO® interface. It also incorporates cutting-edge computer I/O like USB 3.1 Gen2 with up to 10 Gbps throughput and M.2 2280 M key socket for NVMe SSD or Intel® Optane™ memory for ultimate system performance. The plethora of on-board I/O ports (GbE, USB and COM) feature sophisticated protection circuits to endure stress from ESD and power surge. This makes Nuvo-7000 series one of the most solid embedded controller on the market.

Flexible and versatile for a variety of applications, Nuvo-7000 variants are available with different Cassette expansion options. With Neosys Nuvo-7000 series, you get a true rugged platform that can accommodate a single PCIe card (Nuvo-7000E), dual PCIe cards (Nuvo-7000DE) or a single PCI card (Nuvo-7000P) according your application needs.

Specifications

System Core		Expansion Bus	
Processor	Supporting Intel® 9th/ 8th-Gen CPU (LGA1151 socket, 65W/ 35W TDP) - Intel® Core™ i7-9700E/ i7-9700TE/ i7-8700/ i7-8700T - Intel® Core™ i5-9500E/ i5-9500TE/ i5-8500/ i5-8500T - Intel® Core™ i3-9100E/ i3-9100TE/ i3-8100/ i3-8100T - Intel® Pentium® G5400/ G5400T - Intel® Celeron® G4900/ G4900T	PCI/PCI Express	1x PCIe x16 slot@Gen3, 8-lanes PCIe signals in Cassette (Nuvo-7002E/ 7006E) 2x PCIe x16 slots@Gen3, 8-lanes PCIe signals in Cassette (Nuvo-7002DE/ 7006DE) 1x PCI slot in Cassette (Nuvo-7002P/ 7006P)
Chipset	Intel® Q370 platform controller hub	Mini PCI Express	1x full-size mini PCI Express socket with internal SIM socket (mux with mSATA)
Graphics	Integrated Intel® UHD graphics 630	M.2	1x M.2 2242 B key socket with dual front-accessible SIM sockets, supporting dual SIM mode with selected M.2 LTE module
Memory	Up to 64 GB DDR4 2666/ 2400 SDRAM (two SODIMM slots)	Expandable I/O	1x MezIO® expansion port for Neosys MezIO® modules
AMT	Supports AMT 12.0	Power Supply	
TPM	Supports TPM 2.0	DC Input	1x 3-pin pluggable terminal block for 8 to 35V DC input
I/O Interface		Remote Ctrl. & LED Output	1x 3-pin pluggable terminal block for remote control and PWR LED output
Ethernet	2x Gigabit Ethernet ports by I219 and I210 (Nuvo-7002E/ P/ DE) 6x Gigabit Ethernet ports by I219 and 5x I210 (Nuvo-7006E/ P/ DE)	Mechanical	
PoE+	Optional IEEE 802.3at PoE+ PSE for Port 3 ~ Port 6 100 W total power budget	Dimension	240 mm (W) x 225 mm (D) x 90 mm (H) (Nuvo-7000E/ P series) 240 mm (W) x 225 mm (D) x 110.5 mm (H) (Nuvo-7000DE series)
USB 3.1	4x USB 3.1 Gen2 (10 Gbps) ports 4x USB 3.1 Gen1 (5 Gbps) ports	Weight	3.58 kg (Nuvo-7000E/ P series) 3.7 kg (Nuvo-7000DE series)
Video Port (Integrated Graphics)	1x VGA, supporting 1920 x 1200 resolution 1x DVI-D, supporting 1920 x 1200 resolution 1x DisplayPort, supporting 4096 x 2304 resolution	Mounting	Wall-mount (standard) or DIN-rail mount (optional)
Serial Port	2x software-programmable RS-232/ 422/ 485 ports (COM1/ COM2) 2x RS-232 ports (COM3/ COM4)	Environmental	
Audio	1x 3.5 mm jack for mic-in and speaker-out	Operating Temperature	with 35W CPU -25°C ~ 70°C ** with 65W CPU -25°C ~ 70°C **/** (configured as 35W TDP) -25°C ~ 50°C **/** (configured as 65W TDP)
Storage Interface		Storage Temperature	-40°C ~ 85°C
SATA HDD	2x internal SATA port for 2.5" HDD/ SSD installation, supporting RAID 0/ 1	Humidity	10%~90% , non-condensing
M.2	1x M.2 2280 M key socket (PCIe Gen3 x4) for NVMe SSD or Intel® Optane™ memory installation	Vibration	Operating, MIL-STD-810G, Method 514.6, Category 4
mSATA	1x full-size mSATA port (mux with mini-PCIe)	Shock	Operating, MIL-STD-810G, Method 516.6, Procedure I, Table 516.6-II
		EMC	CE/FCC Class A, according to EN 55032 & EN 55024
		Safety	UL62368-1, IEC62368-1

* For i7-9700E and i7-8700 running at 65W mode, the highest operating temperature shall be limited to 50°C and thermal throttling may occur when sustained full-loading applied. Users can configure CPU power in BIOS to obtain higher operating temperature.
** For sub-zero operating temperature, a wide temperature HDD or Solid State Disk (SSD) is required.

Appearance

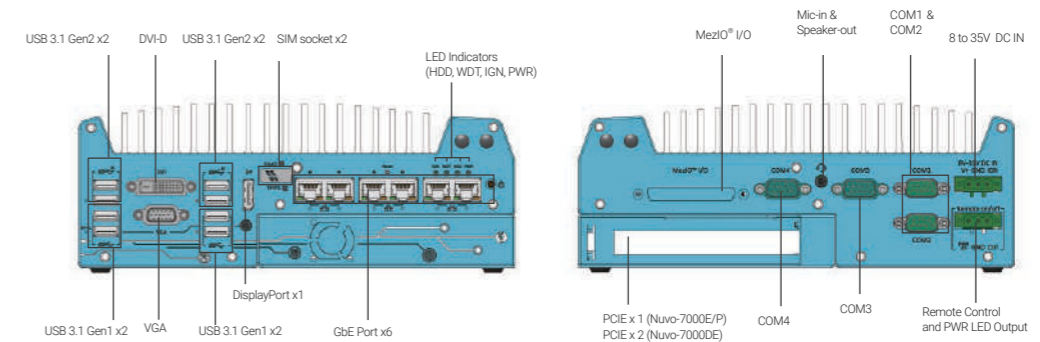

Dimensions

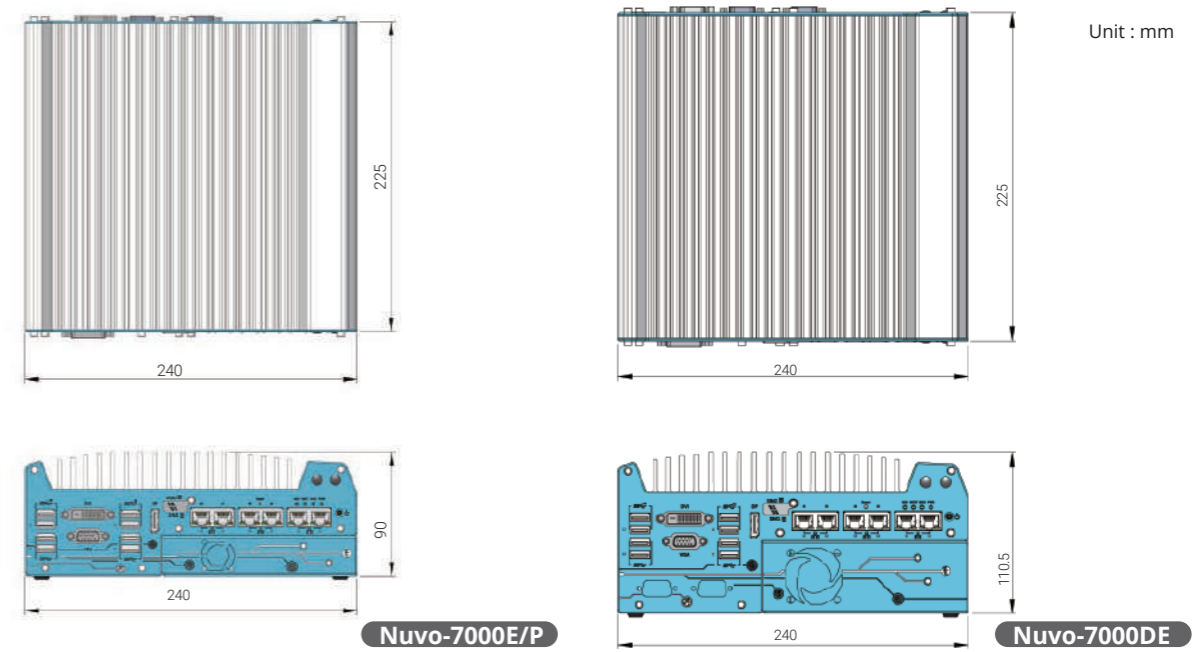

Ordering Information

Model No.	Product Description
Nuvo-7002E	Intel® 9th/ 8th-Gen Core™ fanless controller with 2x GbE, single-slot PCI Express Cassette and MezIO® interface
Nuvo-7002P	Intel® 9th/ 8th-Gen Core™ fanless controller with 2x GbE, single-slot PCI Cassette and MezIO® interface
Nuvo-7006E	Intel® 9th/ 8th-Gen Core™ fanless controller with 6x GbE, single-slot PCI Express Cassette and MezIO® interface
Nuvo-7006P	Intel® 9th/ 8th-Gen Core™ fanless controller with 6x GbE, single-slot PCI Cassette and MezIO® interface
Nuvo-7002DE	Intel® 9th/ 8th-Gen Core™ fanless controller with 2x GbE, dual-slot PCI Express Cassette and MezIO® interface
Nuvo-7006DE	Intel® 9th/ 8th-Gen Core™ fanless controller with 6x GbE, dual-slot PCI Express Cassette and MezIO® interface

Optional IEEE 802.3at PoE+ for GbE ports 3 ~ 6

Optional Accessories

Accessories	Description	MezIO® Modules	Description
DINRAIL-O	DIN-rail mount assembly for Nuvo-7000 series	MezIO®-C180	MezIO® module with 4x RS-232/ 422/ 485 ports and 4x RS-232 ports
Dmpbr-Nuvo5000_7000	Neosys' patented damping brackets assembly for Nuvo-7000E/DE/P	MezIO®-C181	MezIO® module with 4x RS-232/ 422/ 485 ports and 4x RS-422/ 485 ports
Fankit-25	Fan assembly for 1-slot Cassette, 25x25x10 mm	MezIO®-D220	MezIO® module with 8-CH isolated digital input and 8-CH isolated digital output
PA-160W-OW	160W AC/DC power adapter 20V/8A;18AWGx4C/120cm, cord end terminals for terminal block, operating temperature : -30°C to 70°C.	MezIO®-D230	MezIO® module with 16-CH isolated digital input and 16-CH isolated digital output
Cassette Modules (Nuvo-7000 E/P only)		MezIO®-V20-EP	MezIO® module with ignition power control function for in-vehicle application
CSM-PoE354	Cassette module with PCIe-PoE354at and pre-installed passive heat-spreader	MezIO®-U4	MezIO® module with 4x USB 3.1 ports
CSM-R800	Cassette module accommodating four 2.5" HDD/ SSD (support RAID 0/ 1/ 10)	MezIO®-G4	MezIO® module with 4x GigE ports
		MezIO®-G4P	MezIO® module with 4x IEEE 802.3at PoE+ ports

Only Nuvo-7006E-PoE, Nuvo-7006P-PoE and Nuvo-7006DE-PoE support MezIO®-G4P

All specifications and photos are subject to change without prior notice

Nuvo-7000LP Series

Intel® 9th/ 8th-Gen Core™ i7/ i5/ i3 Fanless Controller with 6x GbE Ports, MezIO® Interface and Low-profile Chassis



Key Features

- Intel® 9th/ 8th-Gen Core™ i hexa-core 35W/ 65W LGA1151 CPU
- Low-profile chassis with hot-swappable 2.5" HDD/ SSD tray
- MezIO® interface for easy function expansion
- Rugged, -25°C to 70°C fanless operation
- Up to 6x GigE ports, supporting 9.5 KB jumbo frame
- M.2 2280 M key socket (Gen3 x4) supporting NVMe SSD or Intel® Optane™ memory
- 4x USB 3.1 Gen2 ports and 4x USB 3.1 Gen1 ports
- VGA/ DVI/ DP triple independent display, supporting 4K2K resolution



Introduction

The Neosys Nuvo-7000LP series is powered by Intel® 9th/ 8th-Gen Core™ i processors with up to 6-core/ 8-core architecture that offer a significant performance improvement over previous 6th or 7th-Gen platforms.

Nuvo-7000LP series is a derivative of Nuvo-7000 series that features the same level of ruggedness and versatility in a 79 mm low-profile chassis. In addition to effective fanless design, proprietary MezIO® interface and plethora of on-board I/O interfaces, Nuvo-7000LP series features one front-accessible, hot-swappable HDD/ SSD tray which can be configured as RAID 0/1 when combined with the internal SATA port. It also leverages cutting-edge M.2 NVMe SSD technology for over 2000MB/s disk read/ write speed, or install an Intel® Optane™ memory for the ultimate system acceleration.

Neosys Nuvo-7000LP series consolidates the latest Intel® hexa/octa-core CPU, high-speed I/O interfaces, super-fast disk access and flexible storage configuration to form a high-performance ruggedized embedded controller. In addition, you can also take advantage of the built-in MezIO® interface to add on modules for application-specific I/Os.

Specifications

System Core		Expansion Bus	
Processor	Supporting Intel® 9th/ 8th-Gen CPU (LGA1151 socket, 65W/ 35W TDP) - Intel® Core™ i7-9700E/ i7-9700TE/ i7-8700/ i7-8700T - Intel® Core™ i5-9500E/ i5-9500TE/ i5-8500/ i5-8500T - Intel® Core™ i3-9100E/ i3-9100TE/ i3-8100/ i3-8100T - Intel® Pentium® G5400/ G5400T - Intel® Celeron® G4900/ G4900T	Mini PCI Express	1x full-size mini PCI Express socket with internal SIM socket (mux with mSATA)
Chipset	Intel® Q370 platform controller hub	M.2	1x M.2 2242 B key socket with dual front-accessible SIM sockets
Graphics	Integrated Intel® UHD graphics 630	Expandable I/O	1x MezIO® expansion port for Neosys MezIO® modules
Memory	Up to 64 GB DDR4 2666/ 2400 SDRAM (two SODIMM slots)	Power Supply	
AMT	Supports AMT 12.0	DC Input	1x 3-pin pluggable terminal block for 8 to 35V DC input
TPM	Supports TPM 2.0	Remote Ctrl. & LED Output	1x 3-pin pluggable terminal block for remote control and PWR LED output
I/O Interface		Mechanical	
Ethernet	2x Gigabit Ethernet ports by I219 and I210 (Nuvo-7002LP) 6x Gigabit Ethernet ports by I219 and 5x I210 (Nuvo-7006LP)	Dimension	240 mm (W) x 225 mm (D) x 79 mm (H)
PoE+	Optional IEEE 802.3at PoE+ PSE for Port 3 ~ Port 6 100 W total power budget	Weight	3.1 kg
USB 3.1	4x USB 3.1 Gen2 (10 Gbps) ports 4x USB 3.1 Gen1 (5 Gbps) ports	Mounting	Wall-mount (standard) or DIN-rail mount (optional)
Video Port (Integrated Graphics)	1x VGA, supporting 1920 x 1200 resolution 1x DVI-D, supporting 1920 x 1200 resolution 1x DisplayPort, supporting 4096 x 2304 resolution	Environmental	
Serial Port	2x software-programmable RS-232/422/485 ports (COM1/ COM2) 2x RS-232 ports (COM3/ COM4)	Operating Temperature	with 35W CPU -25°C ~ 70°C ** with 65W CPU -25°C ~ 70°C */** (configured as 35W TDP) -25°C ~ 50°C */** (configured as 65W TDP)
Audio	1x 3.5 mm jack for mic-in and speaker-out	Storage Temperature	-40°C ~ 85°C
Storage Interface		Humidity	10%~90% , non-condensing
SATA HDD	1x front-accessible, hot-swappable 2.5" HDD/ SSD tray 1x internal SATA port for 2.5" HDD/ SSD installation, supporting RAID 0/ 1	Vibration	Operating, MIL-STD-810G, Method 514.6, Category 4
M.2	1x M.2 2280 M key socket (PCIe Gen3 x4) for NVMe SSD or Intel® Optane™ memory installation	Shock	Operating, MIL-STD-810G, Method 516.6, Procedure I, Table 516.6-II
mSATA	1x full-size mSATA port (mux with mini-PCIe)	EMC	CE/FCC Class A, according to EN 55032 & EN 55024
		Safety	UL62368-1, IEC62368-1

* For i7-9700E and i7-8700 running at 65W mode, the highest operating temperature shall be limited to 50°C and thermal throttling may occur when sustained full-loading applied. Users can configure CPU power in BIOS to obtain higher operating temperature.

** For sub-zero operating temperature, a wide temperature HDD or Solid State Disk (SSD) is required.

Appearance

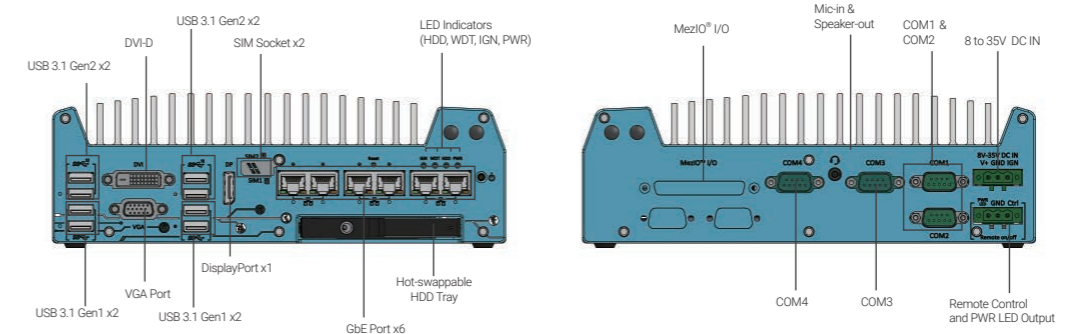

Dimensions

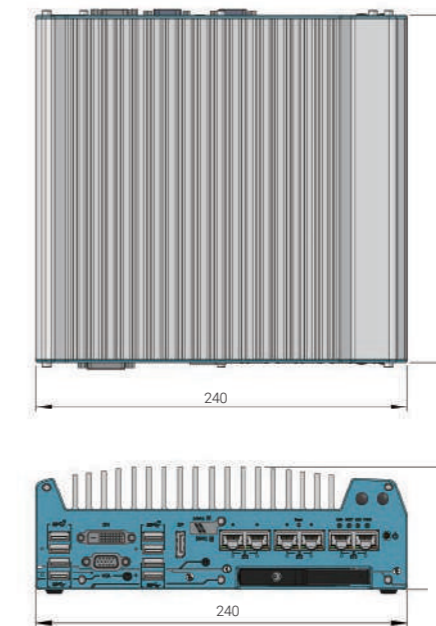

Unit : mm

Ordering Information

Model No.	Product Description
Nuvo-7002LP	Intel® 9th/ 8th-Gen Core™ fanless controller with 2x GbE ports, MezIO® interface and low-profile chassis
Nuvo-7006LP	Intel® 9th/ 8th-Gen Core™ fanless controller with 6x GbE ports, MezIO® interface and low-profile chassis

Optional IEEE 802.3at PoE+ for GbE ports 3 ~ 6

Optional Accessories

PA-160W-OW	160W AC/DC power adapter 20V/8A;18AWGx4C/120cm, cord end terminals for terminal block, operating temperature : -30 to 70°C.
DINRAIL-O	DIN-rail mount assembly for Nuvo-7000 series
Dmpbr-Nuvo5000_7000	Neosys' patented damping brackets assembly for Nuvo-7000E/DE/P/ Nuvo-7000LP
MezIO® Modules	
MezIO®-C180	MezIO® module with 4x RS-232/ 422/ 485 ports and 4x RS-232 ports
MezIO®-C181	MezIO® module with 4x RS-232/ 422/ 485 ports and 4x RS-422/ 485 ports
MezIO®-D220	MezIO® module with 8-CH isolated digital input and 8-CH isolated digital output
MezIO®-D230	MezIO® module with 16-CH isolated digital input and 16-CH isolated digital output
MezIO®-V20-EP	MezIO® module with ignition power control function for in-vehicle application
MezIO®-U4	MezIO® module with 4x USB 3.1 ports
MezIO®-G4	MezIO® module with 4x GigE ports
MezIO®-G4P	MezIO® module with 4x IEEE 802.3at PoE+ ports

Only Nuvo-7006LP-PoE supports MezIO-G4P

Nuvo-7501 Series

Intel® 9th/ 8th -Gen Core™ i7/ i5/ i3 Compact Fanless Computer with 2x GbE and up to 6x COM

Key Features

- Compact 255 x 173 x 76 mm footprint
- Intel® 9th/ 8th-Gen Core™ 35W LGA1151 CPU
- Rugged, -25°C to 60°C fanless operation
- 2x GbE and 4x USB 3.1
- Up to 6x COM ports, optional isolation on ports 1 ~ 4
- VGA + DVI dual display outputs
- Accommodates one 3.5" or 2.5" HDD/ SSD
- 8-CH isolated DI and 8-CH isolated DO (Nuvo-7505D only)



Introduction

Nuvo-7501 series is a cost-effective, compact and yet powerful fanless embedded computer with a 255 x 173 x 76 mm footprint. Powered by an Intel® 9th/ 8th-Gen Core™ hexa/ octa core CPU, it offers more than 50% computation performance improvement over the previous generation.

Nuvo-7501 series is designed to be simple and compact while retaining essential elements of a rugged embedded fanless solution. It features I/Os such as 2x GbE, 4x USB 3.1 and 6x COM ports for common industrial applications. In addition to the M.2 2280 SATA SSD, it can also support a 2.5" SSD/ HDD or a 3.5" HDD. For Nuvo-7505D, it offers isolated DIO and isolated COM, which can protect the controller against ground loops in harsh environments.

The Nuvo-7501 series is a cost-effective solution that has retained quality materials all Neosys systems utilize; and the design flow/ stringent test procedures it must endure. It is a fanless embedded platform that has hit the sweet spot in terms of cost, size and performance. Nuvo-7501 series is an ideal fanless embedded solution for various industrial applications.

Specifications

	Nuvo-7501	Nuvo-7505D		Nuvo-7501	Nuvo-7505D
System Core			Internal Expansion Bus		
Processor	Supporting Intel® 9th/ 8th-Gen Core™ CPU (LGA1151 socket) - Intel® Core™ i7-9700E*/ i7-9700TE/ i7-8700*/ i7-8700T - Intel® Core™ i5-9500E*/ i5-9500TE/ i5-8500*/ i5-8500T - Intel® Core™ i3-9100E*/ i3-9100TE/ i3-8100*/ i3-8100T		Mini PCI-E	1x full-size mini PCI Express socket	
Chipset	Intel® H310 platform controller hub		M.2	1x M.2 2242 B key socket with internal SIM socket	
Graphics	Integrated Intel® UHD graphics 630		Power Supply		
Memory	Up to 32 GB DDR4 2666/ 2400 SDRAM (one SODIMM slots)		DC Input	1x 3-pin pluggable terminal block for 8 to 35V DC input	
I/O Interface			Remote Ctrl & Status Output	1x 10-pin (2x5) pin header for remote on/off control and status LED output	
Ethernet port	2x Gigabit Ethernet ports by I219 and I210		Mechanical		
USB 3.1	4x USB 3.1 Gen1 (5 Gbps) ports		Dimension	255mm (W) x 173 mm (D) x 76 mm (H)	
Video Port	1x VGA, supporting 1920 x 1200 resolution 1x DVI-D, supporting 1920 x 1200 resolution		Weight	2.68 kg	
Serial Port	2x software-programmable RS-232/ 422/ 485 ports (COM1/ COM2) 2x RS-232 ports (COM3/ COM4)	2x isolated software-programmable RS-232/ 422/ 485 ports (COM1/ COM2) 2x isolated RS-232 ports (COM3/ COM4) 2x RS-232 ports (COM5/ COM6)	Mounting	Wall-mount (standard) or DIN-rail mount (optional)	
Audio	1x 3.5 mm jack for mic-in and speaker-out		Environmental		
Isolated DIO	N/A	8-CH isolated DI and 8-CH isolated DO	Operating Temperature	-25°C ~ 60°C **/***	
Storage Interface			Storage Temperature	-40°C ~ 85°C	
SATA HDD	1x internal SATA port for 3.5" HDD or 2.5" HDD/ SSD		Humidity	10%~90% , non-condensing	
M.2	1x M.2 2280 SATA interface		Vibration	Operating, MIL-STD-810G, Method 514.6, Category 4	
			Shock	Operating, MIL-STD-810G, Method 516.6, Procedure I, Table 516.6-II	
			EMC	CE/FCC Class A, according to EN 55032 & EN 55024	

* Due to thermal limitations, 65W CPUs will be configured to operate in 35W mode by default.
** For sub-zero operating temperature, a wide temperature HDD or Solid State Disk (SSD) is required.
*** For i7 CPUs, thermal throttling may occur when sustained full-loading applied at 60°C ambient temperature.

Appearance

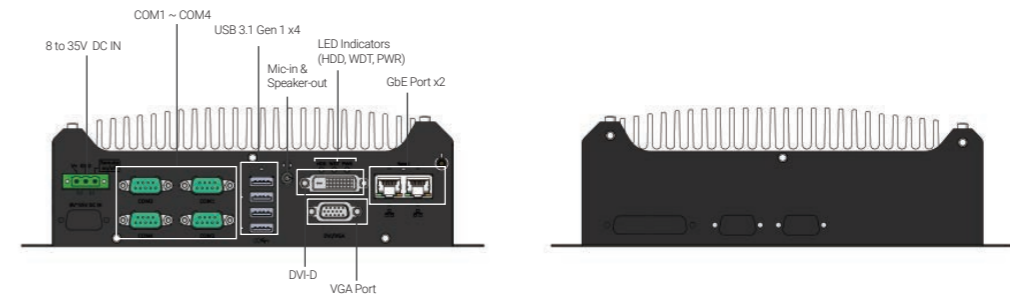

Dimensions

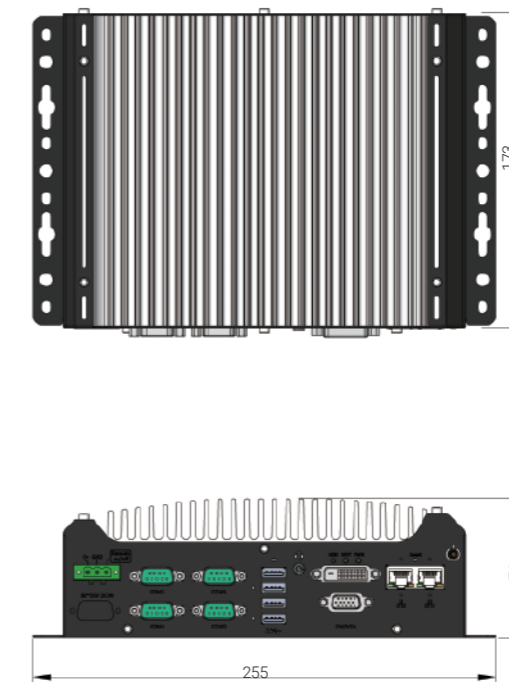

Ordering Information

Model No.	Product Description
Nuvo-7501	Intel® 9th/ 8th-Gen Core™ i7/ i5/ i3 compact fanless embedded computer with 2x GbE and 4x COM
Nuvo-7505D	Intel® 9th/ 8th-Gen Core™ i7/ i5/ i3 compact fanless embedded computer with isolated DIO, isolated COM and 2x GbE

Optional Accessories

PA-120W-OW	120W AC/ DC power adapter 20V/ 6A; 18AWG/ 120cm; cord end terminals for terminal block, operating temperature : -30 to 70 °C
DINRAIL-31	DIN-rail mount assembly for Nuvo-7501 series

Nuvo-7531 Series

Intel® 9th/ 8th -Gen Core™ i7/ i5/ i3 Compact Fanless Computer with 4x GbE , 4x USB3.1 and 1x hot-swappable HDD tray

Key Features

- 212 x 165 x 63 mm low-profile design
- Intel® 9th/ 8th-Gen Core™ 35W/ 65W LGA1151 CPU
- Rugged, -25°C to 60°C fanless operation
- 4x GbE and 4x USB3.1 Gen1 with screw-lock
- 1x hot-swappable HDD tray and 1x M.2 2280 socket for storage
- 4-CH isolated DI and 4-CH isolated DO
- DVI-I + DP dual display outputs
- Optional ignition power control



Introduction

Nuvo-7531 is one of the most compact fanless embedded controller supporting Intel® 9th/ 8th-Gen Core™ CPUs. Measuring just 212 x 165 x 63 mm, it comfortably fits into confined spaces. Despite its compact size, Nuvo-7531 does not compromise on performance. Based on Intel® 9th/ 8th-Gen Core™ 65W/ 35W CPUs, it can deliver more than 50% extra performance compared to the previous generation. Nuvo-7531 is a compact and powerful fanless embedded controller for a variety of industrial applications.

The Nuvo-7531 has abundant I/O functions. It features four GbE ports and four USB3.1 ports for multiple GbE and USB cameras. There is a hot-swappable HDD tray for you to hot-swap the storage drive without turning off the system or dismantle the chassis. There are three mPCIe slots to install WIFI or 3G/ 4G for wireless communication needs. In addition, Nuvo-7531 is also equipped with 8x DIO, 2x COM ports and dual display outputs for your application needs.

For a compact embedded controller, Nuvo-7531 delivers amazing computing power and provides rich I/O functions. It is suitable for a variety of industrial applications, especially when space is limited. Nuvo-7531 is a little giant in the world of rugged embedded controllers.

Specifications

System Core		Power Supply	
Processor	Supporting Intel® 9th/ 8th-Gen Core™ CPU (LGA1151 socket) - Intel® Core™ i7-9700E/ i7-9700TE/ i7-8700/ i7-8700T - Intel® Core™ i5-9500E/ i5-9500TE/ i5-8500/ i5-8500T - Intel® Core™ i3-9100E/ i3-9100TE/ i3-8100/ i3-8100T	DC Input	1x 3-pin pluggable terminal block for 8 to 35V DC input with optional ignition power control
Chipset	Intel® H310 platform controller hub	Remote Ctrl. & LED Output	1x 10-pin (2x5) pin header for remote on/off control and status LED output
Graphics	Integrated Intel® UHD graphics 630	Mechanical	
Memory	Up to 32 GB DDR4 2666/ 2400 SDRAM (one SODIMM slot)	Dimension	212 mm (W) x 165 mm (D) x 63 mm (H)
I/O Interface		Weight	2.5 kg
Ethernet	4x Gigabit Ethernet ports by I219 and 3x I210	Mounting	Wall-mount (standard) or DIN-rail mount (optional)
USB 3.1	4x USB 3.1 Gen1 (5 Gbps) ports	Environmental	
USB 2.0	2x USB 2.0 ports	Operating Temperature	with 35W CPU -25°C ~ 60°C */** with 65W CPU, optional fan kit is required -25°C ~ 60°C */**
Video Port (Integrated Graphics)	1x DVI-I for DVI/VGA output, supporting 1920 x 1200 resolution 1x DisplayPort, supporting 4096 x 2304 resolution	Storage Temperature	-40°C ~ 85°C
Serial Port	2x software-programmable RS-232/ 422/ 485 ports (COM1/ COM2)	Humidity	10%~90% , non-condensing
Audio	1x 3.5 mm jack for mic-in and speaker-out	Vibration	Operating, MIL-STD-810G, Method 514.6, Category 4
Isolated DIO	4-CH isolated DI and 4-CH isolated DO	Shock	Operating, MIL-STD-810G, Method 516.6, Procedure I, Table 516.6-II
Storage Interface		Safety	EN62368-1
SATA HDD	1x hot-swappable 2.5" HDD/ SSD tray	EMC	CE/FCC Class A, according to EN 55032 & EN 55024
M.2	1x M.2 2280 SATA interface	* For sub-zero operating temperature, a wide temperature HDD or Solid State Disk (SSD) is required. ** For i7 CPUs, thermal throttling may occur when sustained full-loading applied at 60°C ambient temperature.	
Internal Expansion Bus			
Mini PCI Express	3x full-size mini PCI Express sockets with internal SIM sockets		

Appearance

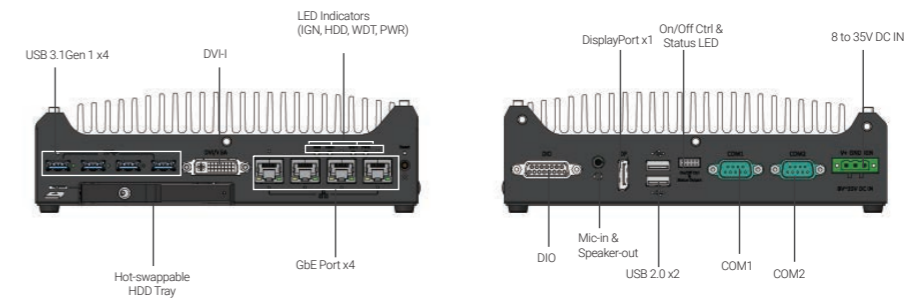

Dimensions

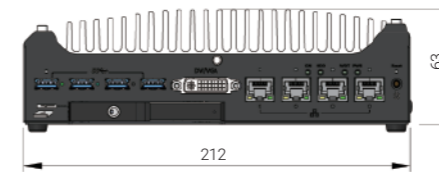
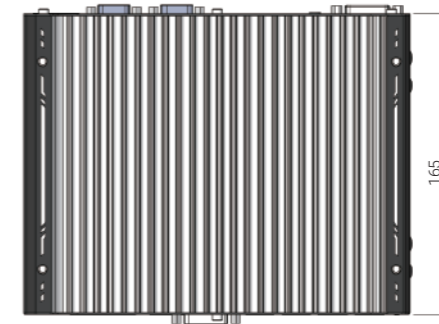

Ordering Information

Model No.	Product Description
Nuvo-7531	Intel® 9th/ 8th -Gen Core™ i7/ i5/ i3 compact fanless computer with 4x GbE , 4x USB 3.1 and a hot-swappable HDD tray
	<i>Optional ignition power control</i>

Optional Accessories

PA-120W-OW	120W AC/ DC power adapter 20V/ 6A; 18AWG/ 120cm; cord end terminals for terminal block, operating temperature : -30°C to 70 °C
DINRAIL-31	DIN-rail mount assembly for Nuvo-7531 series
AccsxBx-FAN-Nuvo-7531	Fan kit with 92mm x 92mm fan for Nuvo-7531 series

Nuvo-5000E/P Series

Intel® 6th-Gen Core™ i7/ i5/ i3 Fanless Controller with 6x GbE, Expansion Cassette and MezIO® Interface

Key Features

- Intel® 6th-Gen Core™ i7/ i5/ i3 35W/65W LGA1151 CPU
- Patented Cassette* for PCI/ PCIe add-on card
- MezIO® interface for easy function expansion
- Rugged, -25°C to 70°C fanless operation
- Up to 6x GigE ports, supporting 9.5 KB jumbo frame
- Up to 32 GB, DDR4-2133 SODIMM
- Accommodates two 2.5" SATA HDD/ SSD with RAID 0/ 1 support
- VGA/ DVI/ DP triple independent display, supporting 4K2K resolution



*R.O.C Patent No. M456527

Introduction

Nuvo-5000 is Neosys' rugged fanless embedded controller with performance and versatility. It supports socket-type 6th-Gen Core™ processors so one can choose a CPU according to application performance needs while Neosys' efficient heat-dissipating design offers true -25°C to 70°C Wide temperature operation.

With plenty of embedded I/O connections for applications including Gigabit Ethernet, USB 3.1/ USB 2.0, COM ports, VGA/ DVI/ DP triple display outputs and if that's not enough, Neosys' patented Cassette offers I/O expansion by installing an off-the-shelf PCIe/PCI card.

On top of all that, Nuvo-5000 also incorporates Neosys MezIO® interface. The patented design enhances Neosys' embedded system with a cost-effective and reliable way for I/O expansion. The MezIO® module can deliver application-oriented functions for diversified vertical markets.

Neosys Nuvo-5000 features 6th-Gen Intel® CPU, patented Cassette and MezIO® to create a powerful and yet diverse controller for all your industrial application needs!

Specifications

System Core	
Processor	Intel® Core™ i7-6700 (8M Cache, 3.4/ 4.0 GHz, 65W TDP)* Intel® Core™ i5-6500 (6M Cache, 3.2/ 3.6 GHz, 65W TDP)* Intel® Core™ i3-6100 (3M Cache, 3.7 GHz, 51W TDP)* Intel® Pentium® G4400 (3M Cache, 3.3 GHz, 54W TDP)* Intel® Celeron® G3900 (2M Cache, 2.8 GHz, 51W TDP)* Intel® Core™ i7-6700TE (8M Cache, 2.4/ 3.4 GHz, 35W TDP) Intel® Core™ i5-6500TE (6M Cache, 2.3/ 3.3 GHz, 35W TDP) Intel® Core™ i3-6100TE (4M Cache, 2.7 GHz, 35W TDP) Intel® Pentium® G4400TE (3M Cache, 2.4 GHz, 35W TDP) Intel® Celeron® G3900TE (2M Cache, 2.3 GHz, 35W TDP)
Chipset	Intel® Q170 platform controller hub
Graphics	Integrated Intel® HD graphics 530/ 510
Memory	Up to 32GB DDR4-2133 SDRAM (two SODIMM slots)
AMT	Supports AMT 11.0
TPM	Supports TPM 2.0
I/O Interface	
Ethernet	2x Gigabit Ethernet ports by Intel® 1x I219 and I210 (Nuvo-5002E/P) 6x Gigabit Ethernet ports by Intel® 1x I219 and 5x I210 (Nuvo-5006E/ P)
PoE+	Optional IEEE 802.3at PoE+ PSE for GbE Ports 3 ~ 6, 80W total power budget
USB 3.1	4x USB 3.1 Gen1 (5 Gbps) ports via native xHCI controller
USB 2.0	4x USB 2.0 ports
Video Port	1x stacked VGA + DVI-D 2x DisplayPort, supporting 4K2K resolution (triple-independent display support)
Serial Port	2x software-programmable RS-232/ 422/ 485 port (COM1 & COM3) 1x RS-232 port (COM2)
Audio	1x mic-in and 1x speaker-out
Storage Interface	
SATA HDD	2x internal SATA port for 2.5" HDD/ SSD installation, supporting RAID 0/1
mSATA	1x full-size mSATA port (mux with mini-PCIe)
Expansion Bus	
PCI/PCI Express	1x PCI slot in Cassette (Nuvo-5002P/5006P) 1x PCIe x16 slot @ Gen3, 8-lanes PCIe signals in Cassette (Nuvo-5002E/ 5006E)
Mini PCI-E	1x internal Mini PCIe socket with front-accessible SIM socket 1x internal Mini PCIe socket with internal SIM socket (mux with mSATA)
Expandable I/O	1x MezIO® expansion port for Neosys' MezIO® modules
Power Supply	
DC Input	1x 3-pin pluggable terminal block for 8 to 35V DC input
Remote Ctrl. & Status Output	1x 10-pin (2x5) wafer connector for remote on/off control and status LED output
Mechanical	
Dimension	240mm (W) x 225mm (D) x 90mm (H)
Weight	3.6kg
Mounting	Wall-mount (standard) or DIN-rail mount (optional)
Environmental	
Operating Temperature	-25°C ~ 70°C ** i7-6700TE (35W TDP) i5-6500TE (35W TDP) i3-6100TE (35W TDP) Pentium G4400TE (35W TDP)
Storage Temperature	-40°C ~ 85°C
Humidity	10%~90% , non-condensing
Vibration	Operating, 5Grms, 5-500 Hz, 3 Axes (w/ SSD, according to IEC60068-2-64)
Shock	Operating, 50Grms, Half-sine 11ms Duration (w/ SSD, according to IEC60068-2-27)
EMC	CE/FCC Class A, according to EN 55022, EN 55024, EN 55032 & EN 60950

* For i7-6700 running at 65W mode, the highest operating temperature shall be limited to 50°C and thermal throttling may occur when sustained full-loading applied. Users can configure CPU power in BIOS to obtain higher operating temperature.

** For sub-zero operating temperature, a wide temperature HDD drive or Solid State Disk (SSD) is required.

Appearance

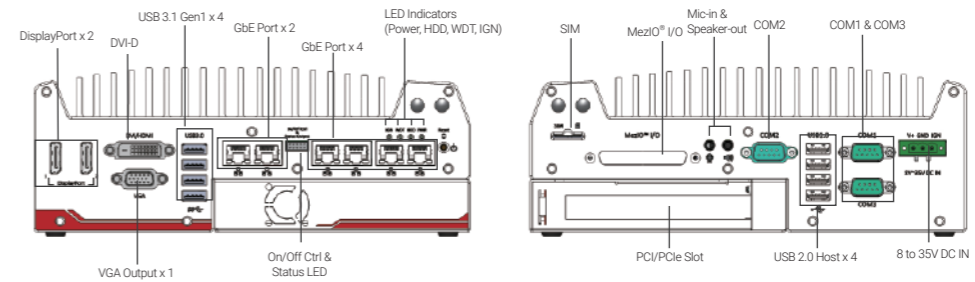

Dimensions

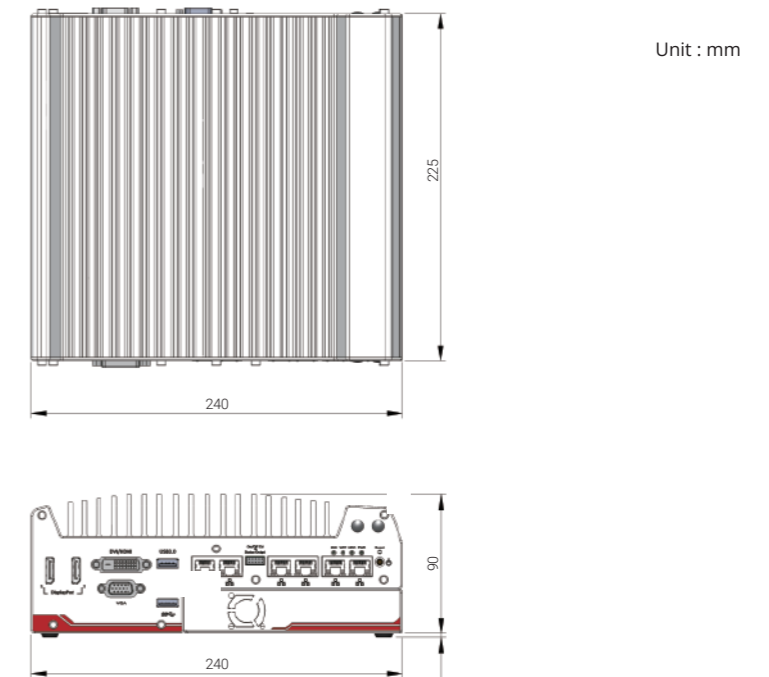

Ordering Information

Model No.	Product Description
Nuvo-5002E	Intel® 6th-Gen Core™ fanless controller with 2x GbE, PCI Express Cassette and MezIO® interface
Nuvo-5002P	Intel® 6th-Gen Core™ fanless controller with 2x GbE, PCI Cassette and MezIO® interface
Nuvo-5006E	Intel® 6th-Gen Core™ fanless controller with 6x GbE, PCI Express Cassette and MezIO® interface
Nuvo-5006P	Intel® 6th-Gen Core™ fanless controller with 6x GbE, PCI Cassette and MezIO® interface

Optional IEEE 802.3at PoE+ for GbE ports 3 ~ 6

Optional Accessories

DINRAIL-O	DIN-rail mount assembly for Nuvo-5000 series	MezIO® Modules
Fankit-25	Fan assembly for 1-slot Cassette, 25x25x10mm	MezIO®-C180
PA-120W-OW	120W AC/DC power adapter 20V/6A; 18AWG/120cm; cord end terminals for terminal block, operating temperature : -30 to 70 °C.	MezIO® module with 4x RS-232/ 422/ 485 ports and 4x RS-232 ports
Dmpbr-Nuvo5000_7000	Neosys' patented damping bracket assembly for Nuvo-7000E/DE/P	MezIO®-C181
Cassette Modules		MezIO® module with 4x RS-232/ 422/ 485 ports and 4x RS-422/ 485 ports
CSM-PoE354	Cassette module with PCIe-PoE354at and pre-installed passive heat-spreader	MezIO®-D220
CSM-R800	Cassette module accommodating four 2.5" HDD/ SSD (support RAID 0/ 1/ 10)	MezIO® module with 8-CH isolated digital input and 8-CH isolated digital output
		MezIO®-D230
		MezIO® module with 16-CH isolated digital input and 16-CH isolated digital output
		MezIO®-V20-EP
		MezIO® module with ignition power control function for in-vehicle application
		MezIO®-U4
		MezIO® module with 4x USB 3.1 ports
		MezIO®-G4
		MezIO® module with 4x GigE ports
		MezIO®-G4P
		MezIO® module with 4x IEEE 802.3at PoE+ ports

Only Nuvo-5006E-PoE and Nuvo-5006P-PoE support MezIO-G4P

Nuvo-5000LP Series

Intel® 6th-Gen Core™ i7/i5/i3 Fanless Controller with 6x GbE, MeziO® Interface and Low-profile Chassis

Key Features

- Intel® 6th-Gen Core™ i7/ i5/ i3 35W/ 65W LGA1151 CPU
- MeziO® interface for easy function expansion
- Rugged, -25°C to 70°C fanless operation
- Up to 6x GigE ports, supporting 9.5 KB jumbo frame
- Up to 32GB, DDR4-2133 SODIMM
- One hot-swappable 2.5" HDD/ SSD and one fixed 2.5" HDD/ SSD, supporting RAID 0/ 1
- VGA/ DVI/ DP triple independent display, supporting 4K2K resolution
- 77mm low-profile design



Introduction

Nuvo-5002LP/ 5006LP are low-profile systems in the Nuvo-5000 family. They feature a 77mm low-profile chassis and yet retain extraordinary -25°C to 70°C wide operating temperature capability. Neosys Nuvo-5002LP/ 5006LP supports LGA1151 socket-type CPUs so one can choose an Intel® 6th-Gen Core™ i7/i5/i3, from 35W to 65W TDP CPU according to application performance and operation needs.

Nuvo-5002LP/ 5006LP has plentiful I/Os such as GbE, USB 3.1/ USB 2.0, COM and VGA/ DVI/ DP. It also incorporates Neosys' MeziO® interface for additional or application-oriented I/O expansion. By installing an optional MeziO® module, Nuvo-5002LP/ 5006LP transforms from a typical embedded controller to a ruggedized application platform that may include up to 11x COM ports, 32 DIO channels, ignition power control or customized application-specific I/Os.

Specifications

System Core		Expansion Bus	
Processor	Intel® Core™ i7-6700 (8M Cache, 3.4/ 4.0 GHz, 65W TDP)*	Mini PCI-E	1x internal mini PCI Express socket with front-accessible SIM socket
	Intel® Core™ i5-6500 (6M Cache, 3.2/ 3.6 GHz, 65W TDP)*		1x internal mini PCI Express socket with internal SIM socket (mux. with mSATA)
	Intel® Core™ i3-6100 (3M Cache, 3.7 GHz, 51W TDP)*	Expandable I/O	1x MeziO® expansion interface for Neosys MeziO® modules
	Intel® Pentium® G4400 (3M Cache, 3.3 GHz, 54W TDP)*		Power Supply
	Intel® Celeron® G3900 (2M Cache, 2.8 GHz, 51W TDP)*	DC Input	1x 3-pin pluggable terminal block for 8 to 35V DC input
	Intel® Core™ i7-6700TE (8M Cache, 2.4/ 3.4 GHz, 35W TDP)	Remote Ctrl. & Status Output	1x 10-pin (2x5) wafer connector for remote on/ off control and status LED output
Intel® Core™ i5-6500TE (6M Cache, 2.3/ 3.3 GHz, 35W TDP)	Mechanical		
Intel® Core™ i3-6100TE (4M Cache, 2.7 GHz, 35W TDP)	Dimension	240mm (W) x 225mm (D) x 77mm (H)	
Intel® Pentium® G4400TE (3M Cache, 2.4 GHz, 35W TDP)	Weight	3.1kg	
Intel® Celeron® G3900TE (2M Cache, 2.3 GHz, 35W TDP)	Mounting	Wall-mount (standard) or DIN-rail mount (optional)	
Chipset	Intel® Q170 platform controller hub	Environmental	
Graphics	Integrated Intel® HD Graphics 530/ 510	Operating Temperature	-25°C ~ 70°C **
Memory	Up to 32GB DDR4-2133 SDRAM (two SODIMM slots)		-25°C ~ 70°C */** (configured as 35W CPU mode)
AMT	Supports AMT 11.0		-25°C ~ 50°C */** (configured as 65W/ 51W CPU mode)
TPM	Supports TPM 2.0	Storage Temperature	-40°C ~ 85°C
I/O Interface		Humidity	10%~90% , non-condensing
Ethernet	2x Gigabit Ethernet ports by Intel® I219 and I210 (Nuvo-5002LP) 6x Gigabit Ethernet ports by Intel® I219 and 5x I210 (Nuvo-5006LP)	Vibration	Operating, 5 Grms, 5-500 Hz, 3 Axes (w/ SSD, according to IEC60068-2-64)
PoE+	Optional IEEE 802.3at PoE+ PSE for GbE Ports 3 ~ 6, 80W total power budget	Shock	Operating, 50 Grms, Half-sine 11 ms Duration (w/ SSD, according to IEC60068-2-27)
USB 3.1	4x USB 3.1 Gen1 (5 Gbps) ports via native xHCI controller	EMC	CE/FCC Class A, according to EN 55022, EN 55024 & EN 55032
USB 2.0	4x USB 2.0 ports	Storage Interface	
Video Port	1x stacked VGA + DVI-D 2x DisplayPort, supporting 4K2K resolution (triple-independent display support)	SATA HDD	1x hot-swappable HDD tray for 2.5" HDD/ SSD installation 1x internal SATA port for 2.5" HDD/ SSD installation, supporting RAID 0/ 1
Serial Port	2x software-programmable RS-232/ 422/ 485 port (COM1 & COM3) 1x RS-232 port (COM2)	mSATA	1x full-size mSATA port (mux with mini-PCIe)
Audio	1x mic-in and 1x speaker-out		

* For i7-6700 running at 65W mode, the highest operating temperature shall be limited to 50°C and thermal throttling may occur when sustained full-loading applied. Users can configure CPU power in BIOS to obtain higher operating temperature.
** For sub-zero operating temperature, a wide temperature HDD drive or Solid State Disk (SSD) is required.

Appearance

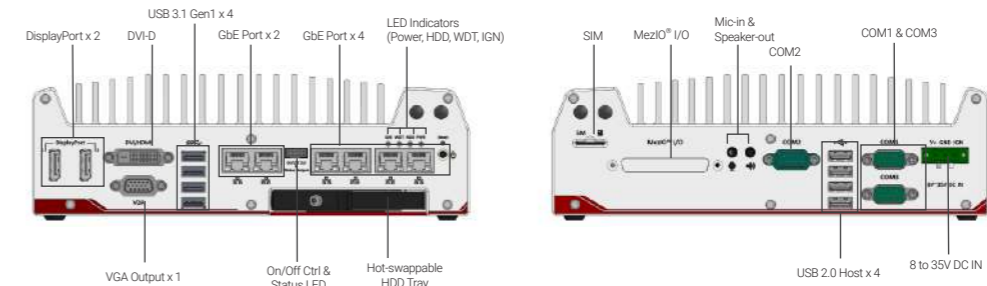

Dimensions

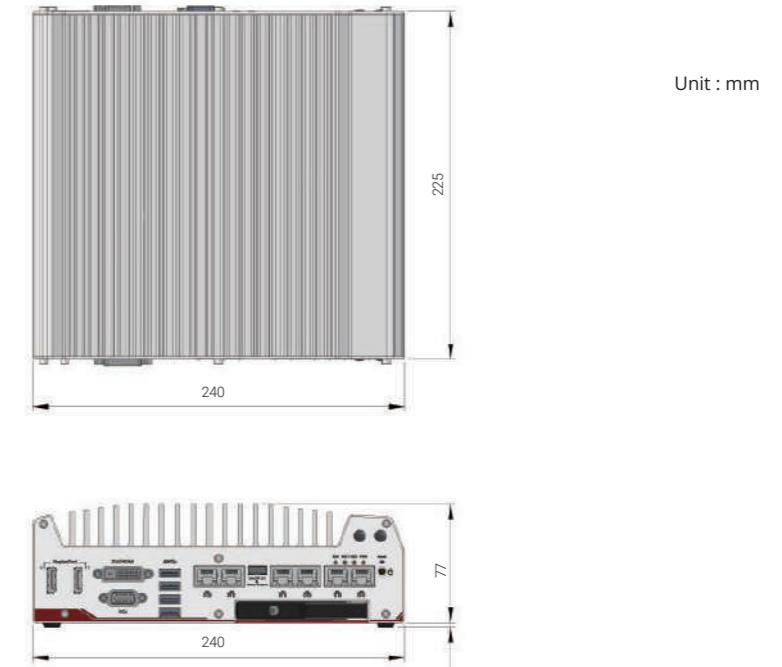

Ordering Information

Model No.	Product Description
Nuvo-5002LP	Intel® 6th-Gen Core™ low-profile fanless controller with 2x GbE and MeziO® interface
Nuvo-5006LP	Intel® 6th-Gen Core™ low-profile fanless controller with 6x GbE and MeziO® interface
Optional IEEE 802.3at PoE+ for GbE ports 3 ~ 6	

Optional Accessories

DINRAIL-O	DIN-rail mount assembly for Nuvo-5000LP series		
PA-120W-OW	120W AC/DC power adapter 20V/6A; 18AWG/120cm; cord end terminals for terminal block, operating temperature : -30°C to 70°C.		
Dmpbr-Nuvo5000_7000	Neosys' patented damping bracket assembly for Nuvo-7000E/DE/P		
MeziO® Modules			
MeziO®-C180	MeziO® module with 4x RS-232/ 422/ 485 ports and 4x RS-232 ports	MeziO®-V20-EP	MeziO® module with ignition power control function for in-vehicle application
MeziO®-C181	MeziO® module with 4x RS-232/ 422/ 485 ports and 4x RS-422/ 485 ports	MeziO®-U4	MeziO® module with 4x USB 3.1 ports
MeziO®-D220	MeziO® module with 8-CH isolated digital input and 8-CH isolated digital output	MeziO®-G4	MeziO® module with 4x GigE ports
MeziO®-D230	MeziO® module with 16-CH isolated digital input and 16-CH isolated digital output	MeziO®-G4P	MeziO® module with 4x IEEE 802.3at PoE ports

Only Nuvo-5006LP-PoE supports MeziO-G4P

Nuvo-5026E Series

Intel® 6th-Gen Core™ i7/ i5/ i3 Fanless Controller with Dual PCIe Slot Expansion Cassette, 6x GbE and MezIO® Interface



Key Features

- Intel® 6th-Gen Core™ i7/ i5/ i3 LGA1151 35W/ 65W
- Dual PCIe x8 slots in patented expansion Cassette*
- MezIO® interface for easy function expansion
- Rugged, -25°C to 70°C fanless operation
- 6x GbE ports, supporting 9.5 KB jumbo frame
- Up to 32 GB, DDR4-2133 SODIMM
- Accommodates two 2.5" SATA HDD/ SSD with RAID 0/1 support
- VGA/ DVI/ DP triple independent display, supporting 4K2K resolution



*R.O.C Patent No. M456527

Introduction

Nuvo-5026E is a member of the Nuvo-5000 family with dual PCIe slots. The dual PCIe slots enhance expansion abilities while preserving all practical features such as ruggedness, performance and versatility. The expandability makes Nuvo-5026E more adaptable to various application needs while the two PCIe slots in the patented expansion Cassette are easy to access for PCIe card installation without the need to disassemble the system.

Nuvo-5026E supports LGA1151 6th-Gen Core™ processors. It offers processor selection flexibility from Core™ i7 to Celeron according to performance needs and operating environment. It also offers plenty of I/O functions such as 6x GbE, 4x USB 3.1, 3x COM ports and triple independent display support. In addition, Neosys' MezIO® interface can also further expand system I/Os offering up to either 11x COM ports, 10x GbE, 8x USB 3.1, 32x DIO or ignition power control by installing an optional MezIO® module.

Nuvo-5026E is an expandable and flexible platform with numerous I/O functions for various industrial applications.

Specifications

System Core	Expansion Bus
Processor Intel® Core™ i7-6700 (8M Cache, 3.4/ 4.0 GHz, 65W TDP)* Intel® Core™ i5-6500 (6M Cache, 3.2/ 3.6 GHz, 65W TDP)* Intel® Core™ i3-6100 (3M Cache, 3.7 GHz, 51W TDP)* Intel® Pentium® G4400 (3M Cache, 3.3 GHz, 54W TDP)* Intel® Celeron® G3900 (2M Cache, 2.8 GHz, 51W TDP)* Intel® Core™ i7-6700TE (8M Cache, 2.4/ 3.4 GHz, 35W TDP) Intel® Core™ i5-6500TE (6M Cache, 2.3/ 3.3 GHz, 35W TDP) Intel® Core™ i3-6100TE (4M Cache, 2.7 GHz, 35W TDP) Intel® Pentium® G4400TE (3M Cache, 2.4 GHz, 35W TDP) Intel® Celeron® G3900TE (2M Cache, 2.3 GHz, 35W TDP)	PCI/PCI Express 2x PCIe x8 slot @ Gen3, 4-lanes PCIe signals in expansion Cassette Mini PCI-E 1x internal mini PCI Express socket with front-accessible SIM socket (mux with mSATA) Expandable I/O 1x MezIO® expansion port for Neosys' MezIO® modules
Chipset Intel® Q170 platform controller hub Graphics Integrated Intel® HD graphics 530 or 510 (CPU dependent) Memory Up to 32 GB DDR4-2133 SDRAM (two SODIMM slots) AMT Supports AMT 11.0 TPM Supports TPM 2.0	Power Supply DC Input 1x 3-pin pluggable terminal block for 8 to 35V DC input Remote Ctrl. & Status Output 1x 10-pin (2x5) wafer connector for remote on/off control and status LED output
I/O Interface Ethernet 6x Gigabit Ethernet ports by Intel® I219 and 5x I210 PoE+ Optional IEEE 802.3at PoE+ PSE for GbE Port 3 ~ Port 6, 80 W total power budget USB 3.1 4x USB 3.1 Gen1 (5 Gbps) ports via native xHCI controller USB 2.0 4x USB 2.0 ports Video Port 1x stacked VGA + DVI-D 2x DisplayPort, supporting 4K2K resolution Serial Port 2x software-programmable RS-232/ 422/ 485 port (COM1 & COM3) 1x RS-232 port (COM2) Audio 1x mic-in and 1x Speaker-out	Mechanical Dimension 240 mm (W) x 225 mm (D) x 111 mm (H) Weight 3.7 kg Mounting Wall-mount (standard) or DIN-rail mount (optional)
Storage Interface SATA HDD 2x internal SATA port for 2.5" HDD/ SSD installation, supporting RAID 0/ 1 mSATA 1x full-size mSATA port (mux with mini-PCIe)	Environmental Operating Temperature -25°C ~ 70°C ** -25°C ~ 70°C */** (configured as 35W CPU mode) -25°C ~ 50°C */** (configured as 65W/ 51W CPU mode) Storage Temperature -40°C ~ 85°C Humidity 10%~90% , non-condensing Vibration Operating, 5 Grms, 5-500 Hz, 3 Axes (w/ SSD, according to IEC60068-2-64) Shock Operating, 50 Grms, Half-sine 11 ms Duration (w/ SSD, according to IEC60068-2-27) EMC CE/ FCC Class A, according to EN55024 & EN55032

* For i7-6700 running at 65W mode, the highest operating temperature shall be limited to 50°C and thermal throttling may occur when sustained full-loading applied. Users can configure CPU power in BIOS to obtain higher operating temperature.
 ** For sub-zero operating temperature, a wide temperature HDD drive or Solid State Disk (SSD) is required.

Appearance

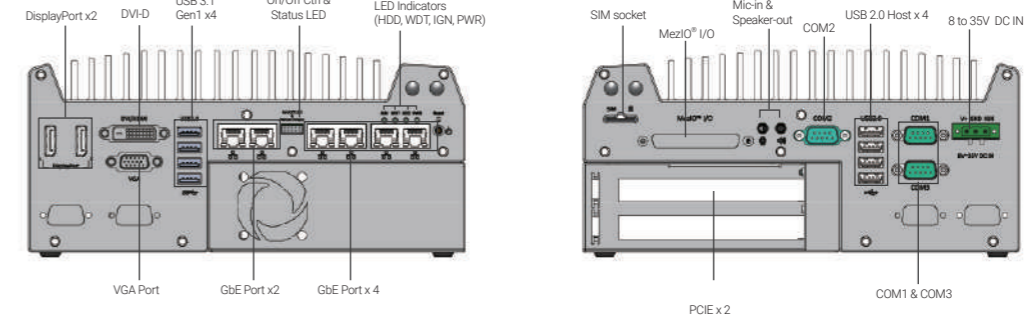

Dimensions

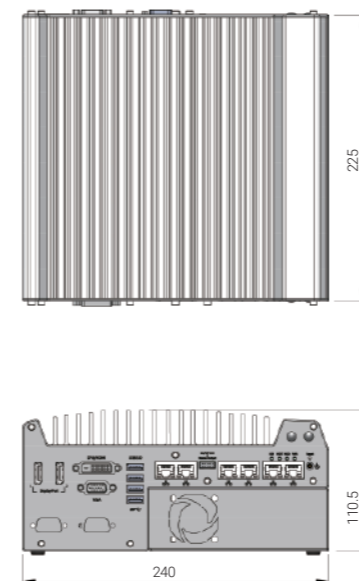

Unit : mm



▲ Nuvo-5026E



▲ Dual PCIe Cassette

Ordering Information

Model No.	Product Description
Nuvo-5026E	Intel® 6th-Gen Core™ fanless controller with dual PCIe Cassette, 6x GbE and MezIO® interface
Optional IEEE 802.3at PoE+ for GbE ports 3 ~ 6	

Optional Accessories

PA-160W-OW	160W AC/DC power adapter 20V/8A; 18AWGx4C/120cm, cord end terminals for terminal block. operating temperature : -30 to 70 °C.
DINRAIL-O	DIN-rail mount assembly for Nuvo-5026E series
Dmpbr-Nuvo5000_7000	Neosys' patented damping bracket assembly for Nuvo-7000E/DE/P
MezIO® Modules	
MezIO®-C180	MezIO® module with 4x RS-232/422/485 ports and 4x RS-232 ports
MezIO®-C181	MezIO® module with 4x RS-232/422/485 ports and 4x RS-422/485 ports
MezIO®-D220	MezIO® module with 8-CH isolated digital input and 8-CH isolated digital output
MezIO®-D230	MezIO® module with 16-CH isolated digital input and 16-CH isolated digital output
MezIO®-V20-EP	MezIO® module with ignition power control function for in-vehicle usage
MezIO®-G4P	MezIO® module with 4x Gigabit 802.3at PoE+ ports
MezIO®-G4	MezIO® module with 4x Gigabit Ethernet ports
MezIO®-U4	MezIO® module with 4x USB 3.1 ports

Only Nuvo-5026E-PoE supports MezIO-G4P

Nuvo-5501 Series

Intel® 6th-Gen Core™ i7/ i5/ i3 Compact Fanless Embedded Controller with 3x GbE

Key Features

- Compact 221 x 173 x 76.2 mm footprint
- Supports Intel® 6th-Gen Core™ i7/ i5/ i3 LGA 1151 socket CPU
- Rugged, -25°C to 70°C wide temperature fanless operation
- 3x GbE and 4x USB 3.1 ports
- 2x RS-232/ 422/ 485 ports and 2x RS-232 ports
- VGA + DVI dual display outputs
- Accommodates one 3.5" HDD or 2.5" HDD/ SSD
- Optional 8-CH isolated DI and 8-CH isolated DO



Introduction

Nuvo-5501 series features compact fanless embedded controllers for the cost and space conscious. Based on Intel® Skylake platform, it is designed to provide cutting-edge performance and reliable operation in extreme environment. Its LGA 1151 socket offers users the flexibility to select a 35W CPU from Intel® 6th-Gen Core™ i to Celeron® lineup to suit application needs.

Nuvo-5501 is the most compact fanless embedded controller supporting Skylake LGA 1151 socket CPUs, measuring just 221 x 173 x 76.2 mm, it is easy to deploy in restricted spaces. In its compact enclosure, Nuvo-5501 features rich, front-accessible I/Os including 3x GbE, 4x USB 3.1 and 4x COM ports. There is even enough room for a 3.5" HDD, compatible with the latest storage capacities.

The compact Nuvo-5501 is a cost-effective solution that does not compromise on performance and reliability, making it the ideal embedded controller for various industrial applications.

Specifications

System Core	Expansion Bus/ Internal I/O Interface
Processor - Intel® Core™ i7-6700TE (8M Cache, 2.4/ 3.4 GHz, 35W TDP) - Intel® Core™ i5-6500TE (6M Cache, 2.3/ 3.3 GHz, 35W TDP) - Intel® Core™ i3-6100TE (4M Cache, 2.7 GHz, 35W TDP) - Intel® Pentium® G4400TE (3M Cache, 2.4 GHz, 35W TDP) - Intel® Celeron® G3900TE (2M Cache, 2.3 GHz, 35W TDP)	mini-PCIe 1x full-size mini PCI Express socket M.2 1x M.2 B key socket for 3G/ 4G options with SIM socket USB 1x internal USB 2.0 port Remote Ctrl. & Status Output 1x 2x6-pin 2.0mm pin-header connector for remote on/off control and status LED output
Chipset Intel® H110 platform controller hub Graphics Integrated Intel® HD 530/ 510 controller Memory Up to 16GB DDR4-2133 (single SODIMM slot)	Power Supply DC Input 1x 3-pin pluggable terminal block for 8 to 35V DC input
I/O Interface Ethernet port 1x Gigabit Ethernet port (via Intel® I219-LM) 2x Gigabit Ethernet port (via Intel® I210-IT) USB 3.1 4x USB 3.1 Gen1 (5 Gbps) ports USB 2.0 2x USB 2.0 ports Video port 1x VGA 1x DVI-D Serial Port 2x software-programmable RS-232/ 422/ 485 ports 2x RS-232 ports Isolated DIO 8-CH isolated DI and 8-CH isolated DO (optional)	Mechanical Dimension 221 mm (W) x 173 mm (D) x 76 mm (H) Weight 2.8 Kg Mounting Wall-mount (standard) or DIN-rail mount (optional)
Storage Interface SATA HDD 1x internal SATA port for 3.5" HDD or 2.5" HDD/ SSD mSATA 1x full-size mSATA socket	Environmental Operating Temperature -25°C ~ 70°C */** Storage Temperature -40°C ~ 85°C Humidity 10%~90% , non-condensing Vibration Operating, 5 Grms, 5-500 Hz, 3 Axes (w/ SSD, according to IEC60068-2-64) Shock Operating, 50 Grms, half-sine 11 ms duration (w/ SSD, according to IEC60068-2-27) EMC CE/ FCC Class A, according to EN 55022, EN 55024 & EN 55032

* For i7-6700 running at 65W mode, the highest operating temperature shall be limited to 50°C and thermal throttling may occur when sustained full-loading applied. Users can configure CPU power in BIOS to obtain higher operating temperature.
 ** For sub-zero operating temperature, a wide temperature HDD drive or Solid State Disk (SSD) is required.

Appearance

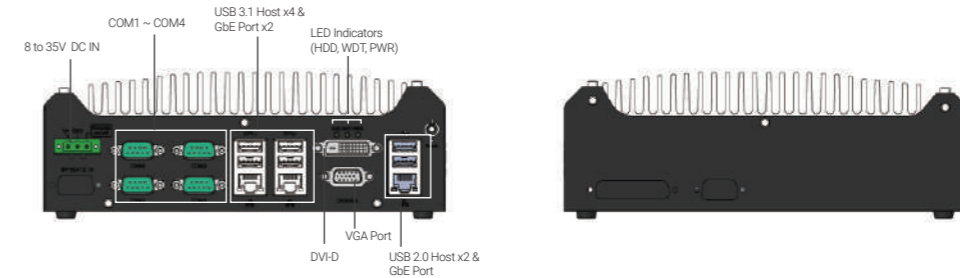

Dimensions

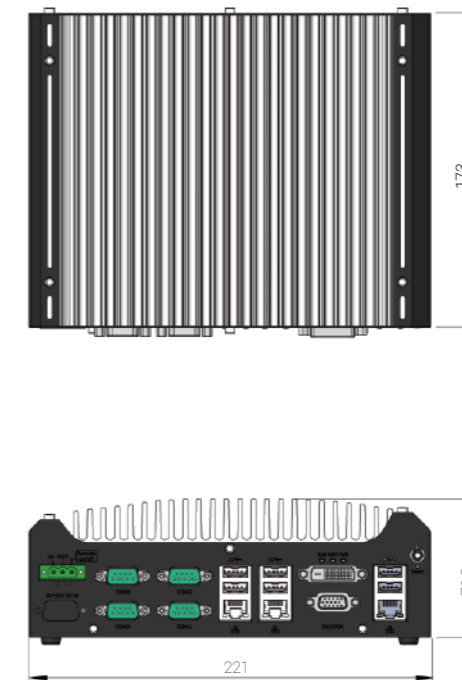

Ordering Information

Model No.	Product Description
Nuvo-5501	Intel® 6th-Gen Core™ compact fanless embedded controller with 3x GbE
Nuvo-5501-DIO	Intel® 6th-Gen Core™ compact fanless embedded controller with isolated DIO & 3x GbE

Optional Accessories

DINRAIL-31	DIN-rail mount assembly for Nuvo-5501 series
PA-120W-OW	120W AC/DC power adapter 20V/6A; 18AWG/120cm; cord end terminals for terminal block, operating temperature : -30 to 70 °C.

Nuvo-2600 Series

Intel® Elkhart Lake Atom® x6425E Fanless Box-PC with 4x PoE+, 7/15mm 2.5" HDD and PCIe Expansion Cassette



Key Features

- Intel® Elkhart Lake Atom® x6425E quad-core 2.0GHz/ 3.0GHz 12W processor
- Rugged -25°C to 70°C fanless operation
- 4x Gigabit PoE+ ports via RJ-45 connector with screw-lock
- 1x isolated RS-485 port and 1x RS-422/485 or 3x 3-wire RS-232 ports
- 2x full-size mini-PCIe sockets and 1x M.2 3042/3052 B key
- 1x front-accessible 2.5" SATA SSD tray (up to 15mm height) and 1x M.2 2280 SATA
- 1x patented Cassette for single-slot PCIe card (Nuvo-2600E), or 1x 2500 watt-second SuperCAP UPS (Nuvo-2600J)
- 8V to 35V wide-range DC input with remote control and optional ignition power control

Introduction

The Nuvo-2600 series is an Intel® Elkhart Lake Atom® fanless box-PC with flexible expansions to fulfill versatile factory automation and machine vision applications that require a compact footprint, Gigabit PoE+ capability, and front-accessible data storage with CPU performance at 12W of low power consumption.

Powered by Intel® Elkhart Lake Atom® x6425E quad-core CPU, the Nuvo-2600 series delivers 320% CPU performance improvement compared with our previous Nuvo-2500E series. The Nuvo-2600 series has four Gigabit PoE+ and one USB 3.1 port with screw-lock mechanisms to secure camera connections. In addition to its internal M.2 2280 SATA SSD for system storage, Nuvo-2600 has one front-accessible 2.5" HDD tray accommodating a 7-15mm 2.5" SSD/HDD up to 5TB in storage capacity. It also has one isolated RS-485 port and isolated DIO to provide robust connections with industrial devices. For internal expansion, the Nuvo-2600 series provides two mini-PCIe sockets and one M.2 3042/3052 B Key socket to support 4G/5G mobile broadband.

To meet diverse deployment requirements, the Nuvo-2600 series comes in two variants. The Nuvo-2600E has a PCIe Cassette for an additional PCIe card, e.g., USB or GbE frame grabber, isolated DIO, or industrial communication card. While Nuvo-2600J has an integrated SuperCAP UPS that can withstand power interruption or voltage fluctuation in industrial environments. Featuring Intel Elhart Lake Atom® quad-core CPU, wide temperature operation, industrial I/O interfaces, and expansion Cassette module, Nuvo-2600 series is the perfect, multi-purpose fanless box-PC for factory automation and machine vision applications.

Specifications

System Core	
Processor	Intel® Elkhart Lake Atom® x6425E quad-core 2.0GHz/3.0GHz 12W processor
Graphics	Integrated Intel® UHD Graphics
Memory	Up to 32 GB DDR4-3200 SDRAM by one SODIMM socket
Panel I/O Interface	
Ethernet port	4x Gigabit Ethernet ports via RJ-45 connectors with screw-lock
PoE Capability	In compliant with IEEE 802.3at PoE+ PSE, maximal 25.5W output on single PoE+ port. Compatible with 802.3at (PoE+) and 802.3af (PoE) PD
Video Port	VGA and DVI dual display outputs via DVI-I connector
USB 3.1	1x USB 3.1 Gen1 (5 Gbps) ports with screw-lock
USB 2.0	2x USB 2.0 port with screw-lock
Serial Port	1x isolated RS-485 port with 15 kV ESD protection (COM1) 3x 3-wire RS-232 ports (COM2/3/4) or 1x RS-422/485 (COM2)
Audio	1x 3.5 mm jack for mic-in and speaker-out
Isolated DIO	4-CH isolated DI and 4-CH isolated DO
Internal I/O Interface	
PCIe	1x PCIe x4 slot @ 2-lane PCIe 3.0 signal in Cassette (Nuvo-2600E only)
Mini-PCIe	1x full-size mini PCI Express socket with PCIe and USB 2.0 signal 1x full-size mini PCI Express socket with USB 2.0 signal
M.2 B key	1x M.2 3042/3052 B key (USB 3.1 + USB 2.0) for 4G/5G module with dual internal micro SIM socket
Storage Interface	
M.2 SATA	1x M.2 2280 M key (SATA interface only) socket for SATA SSD installation
SATA HDD	1x front-accessible HDD tray for 2.5" HDD/ SSD installation (up to 15mm height)
Power Supply	
DC Input	1x 3-pin pluggable terminal block for 8V to 35V DC input with optional ignition power control
Remote Ctrl. & LED Output	1x 3-pin pluggable terminal block for remote control and PWR LED output
Power Backup	
Capacity	2500 watt-second (Nuvo-2600J only)
Mechanical	
Dimension	205 mm (W) x 155 mm (D) x 86 mm (H)
Weight	2.3 kg (Nuvo-2600E) 2.5 kg (Nuvo-2600J)
Mounting	Wall-mount bracket (optional)
Environmental	
Operating Temperature	-25°C ~ 70°C*
Storage Temperature	-40°C ~ 85°C
Humidity	10%~90% , non-condensing
Vibration	Operating, MIL-STD-810G, Method 514.7, Category 4
Shock	Operating, MIL-STD-810G, Method 516.7, Procedure I
EMC	CE/FCC Class A, according to EN 55032 & EN 55035

** For sub-zero operating temperature, a wide temperature HDD drive or Solid State Disk (SSD) is required.

Appearance

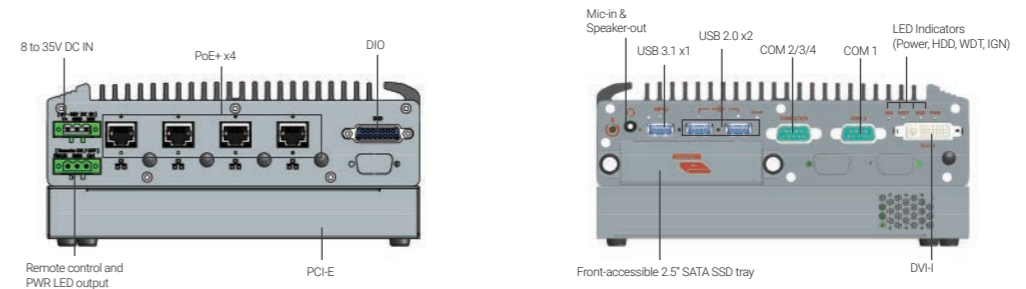

Dimensions

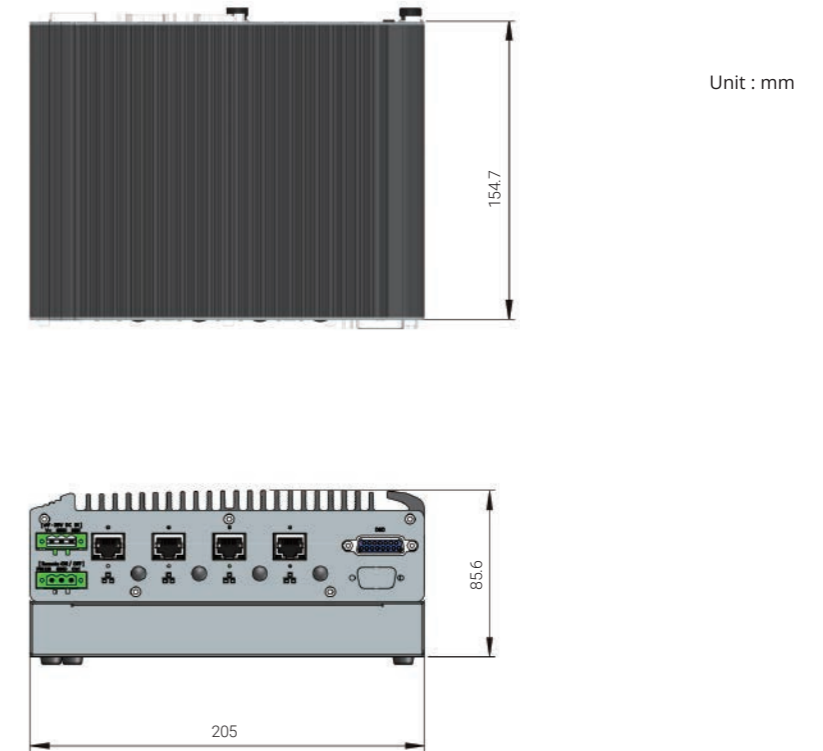

Ordering Information

Model No.	Product Description
Nuvo-2600E	Intel® Elkhart Lake Atom® x6425E fanless box PC with 4x GbE, 7/15mm 2.5" HDD and PCIe expansion Cassette
Nuvo-2600E-PoE	Intel® Elkhart Lake Atom® x6425E fanless box PC with 4x PoE+ GbE, 7/15mm 2.5" HDD and PCIe expansion Cassette
Nuvo-2600E-IGN	Intel® Elkhart Lake Atom® x6425E fanless box PC with 4x GbE, 7/15mm 2.5" HDD and PCIe expansion Cassette and ignition power control
Nuvo-2600E-PoE-IGN	Intel® Elkhart Lake Atom® x6425E fanless box PC with 4x PoE+ GbE, 7/15mm 2.5" HDD and PCIe expansion Cassette and ignition power control
Nuvo-2600J	Intel® Elkhart Lake Atom® x6425E fanless box PC with 4x GbE, 7/15mm 2.5" HDD and SuperCAP UPS
Nuvo-2600J-PoE	Intel® Elkhart Lake Atom® x6425E fanless box PC with 4x PoE+ GbE, 7/15mm 2.5" HDD and SuperCAP UPS
Nuvo-2600J-IGN	Intel® Elkhart Lake Atom® x6425E fanless box PC with 4x GbE, 7/15mm 2.5" HDD and SuperCAP UPS and ignition power control
Nuvo-2600J-PoE-IGN	Intel® Elkhart Lake Atom® x6425E fanless box PC with 4x PoE+ GbE, 7/15mm 2.5" HDD and SuperCAP UPS and ignition power control

Optional Accessories

PA-120W-OW	120W AC/DC power adapter 20V/6A; 18AWG/120cm; cord end terminals for terminal block, operating temperature: -30 to 70°C.
PA-160W-OW	160W AC-DC power adapter 20V/8A; 18AWG/120cm; cord end terminals for terminal block, operating temperature: -30 to 70°C.
Wmkit-Nuvo-2600	Wall mounting kit for Nuvo-2600 and Nuvo-2610VTC series, including wall mounting brackets and screws
Fankit-25	Single fan kit for the PCIe cassette of Nuvo-2600 and Nuvo-2610VTC series, including one 25x25mm fan and screws

Nuvo-8034 Series

Intel® 9th/ 8th-Gen Core™ i7/ i5/ i3 Expansion Box-PC with 7 PCIe/ PCI Expansion Slots



Key Features

- Supports Intel® 9th/ 8th-Gen Core™ i7/ i5/ i3 LGA1151 CPU
- Two x16 PCIe, two x8 PCIe, and three PCI slots
- Supports single NVIDIA® GPU card with up to 180W TDP
- 8-ch isolated DI and 8-ch isolated DO
- 2x GbE ports with screw-lock
- 4x USB 3.1 Gen2 and 4x USB 3.1 Gen1 ports with screw-lock
- Two front-accessible, hot-swappable 2.5" SATA HDD/ SSD with RAID 0/ 1 support
- M.2 2280 M key NVMe (Gen3 x4) for fast storage access

Introduction

Nuvo-8034 is a new-breed of box-PC offering 7 expansion slots in a comparatively compact size. Of its four PCIe slots, two are x16 slots (@Gen3, 8-lanes) connected directly to the CPU PEG port to deliver up to 8 GB/s bandwidth for GPU and high speed I/O cards, and two are x8 slots (@Gen3, 4-lanes) from PCH for general-purpose usage. The system is capable of accommodating one 180W NVIDIA® GPU for modern AI applications. Additionally, there are 3 PCI slots to support legacy PCI cards for general industrial usage.

Nuvo-8034 supports Intel® 9th/ 8th-Gen Core™ i processor with workstation-grade Intel® C246 chipset to offer superior computing power. Utilizing Neosys' distinctive power design, Nuvo-8034 can handle heavy power consumption of multiple PCIe and PCI expansion cards with 8 to 35V wide-range DC input. The system features two hot-swappable trays that support 2.5" SATA SSD/ HDD on the front panel with RAID 0/ 1 support, making it easier to access when placed inside a cabinet. External I/O wise, Nuvo-8034 offers 8-channel isolated DI and 8-channel isolated DO for industrial automation, eight USB 3.1 Gen1/ Gen2 ports with screw-lock for USB3 cameras.

With an assortment of I/O ports and flexible 7-slot PCIe/ PCI expandability, Nuvo-8034 is an all-around rugged solution that can satisfy various industrial applications such as machine vision, industrial automation and data analytics.

Specifications

System Core	
Processor	Supporting Intel® Xeon® E and 9th/ 8th - Gen CPU (LGA1151 socket) - Intel® Xeon® Processor E-2176G/ E-2124G/ E-2278GE/ E-2278GEL - Intel® Core™ i7-9700E/ i7-9700TE/ i7-8700/ i7-8700T - Intel® Core™ i5-9500E/ i5-9500TE/ i5-8500/ i5-8500T - Intel® Core™ i3-9100E/ i3-9100TE/ i3-8100/ i3-8100T
Chipset	Intel® C246 platform controller hub
Graphics	Independent GPU via x16 (@ x8 signals) PEG port, or integrated Intel® UHD graphics 630
Memory	Up to 128 GB ECC/ non-ECC DDR4 2133 SDRAM (four SODIMM slots)
AMT	Supports AMT 12.0
TPM	Supports TPM 2.0
I/O Interface	
Ethernet	1x Gigabit Ethernet port by Intel® I219-LM with screw-lock 1x Gigabit Ethernet port by Intel® I210-IT with screw-lock
Video Port	1x VGA, supporting 1920 x 1200 resolution 1x DVI-D, supporting 1920 x 1200 resolution 1x DisplayPort, supporting 4096 x 2304 resolution
Serial Port	2x software-programmable RS-232/422/485 ports (COM1/ COM2) 2x RS-232 ports (COM3/ COM4) (optional)
USB 3.1	4x USB 3.1 Gen2 (10 Gbps) ports with screw-lock 4x USB 3.1 Gen1 (5 Gbps) ports with screw-lock
USB 2.0	1x USB 2.0 port (internal use)
Isolated DIO	8x isolated DI and 8x isolated DO
Audio	1x 3.5 mm jack for mic-in and speaker-out
Storage Interface	
SATA HDD/ SSD	2x hot-swappable trays for 2.5" HDD/ SSD installation, supporting RAID 0/ 1
M.2	1x M.2 2280 M key socket (PCIe Gen3 x4) for NVMe SSD or Intel® Optane™ memory
Storage Interface	
mSATA	2x full-size mSATA port (mux with mini-PCIe)
Internal Expansion Bus	
PCI Express	2x PCIe x16 slot@Gen3, 8-lanes 2x PCIe x8 slots@Gen3, 4-lanes
PCI	3x 33MHz/ 32-bit 5V PCI slots
M.2	1x M.2 2242 B key socket supporting dual SIM mode with selected M.2 LTE module
mini-PCIe	2x full-size mini PCI Express socket with internal SIM socket (mux. with mSATA)
Power Supply	
DC Input	1x 3-pin pluggable terminal block for 8 to 35V DC input
Remote Ctrl.	1x 3-pin pluggable terminal block for remote control
Mechanical	
Dimension	259mm(W) x 280mm(D) x 198mm(H)
Weight	7kg
Mounting	Wall-mount
Environmental	
Operating Temperature	-25°C ~ 60°C with 100% CPU/ GPU loading
Storage Temperature	-40°C ~ 85°C
Humidity	10%~90% , non-condensing
Vibration	Operating, MIL-STD-810G, Method 514.6, Category 4
Shock	Operating, MIL-STD-810G, Method 516.6, Procedure I, Table 516.6-II
EMC	CE/FCC Class A, according to EN 55032 & EN 55024

* For i7-9700E and i7-8700 running at 65W mode, the highest operating temperature shall be limited to 50°C and thermal throttling may occur when sustained full-loading applied. Users can configure CPU power in BIOS to obtain higher operating temperature.
** For sub-zero operating temperature, a wide temperature HDD or Solid State Disk (SSD) is required.

Appearance

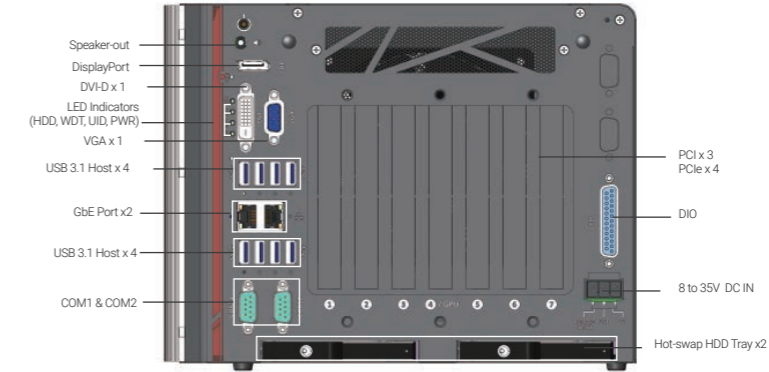

Dimensions

Unit : mm

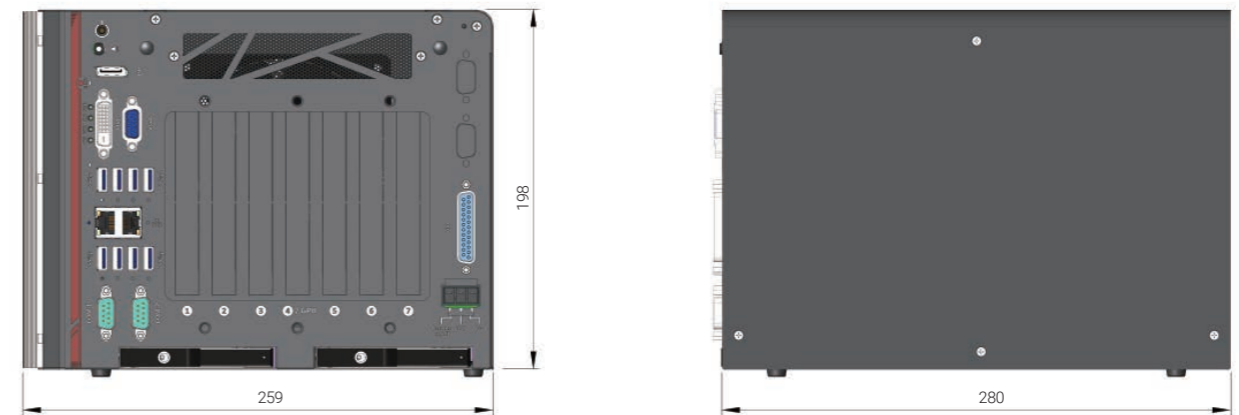

Ordering Information

Model No.	Product Description
Nuvo-8034	Intel® 9th/ 8th-Gen Core™ i7/ i5/ i3 embedded computer with 2x PCIe x16(@ x8 signals), 2x PCIe x8(@ x4 signals) and 3x PCI slots

Optional Accessories

PA-160W-OW	160W AC-DC power Adapter, 20V 8A, 90~264VAC 127~370VDC, Open-Wire Terminal, -30°C to 70°C
PA-280W-ET2	280W AC/DC power adapter 24V/11.67A; 16AWG/100cm; cord end terminals for terminal block, operating temperature : -30°C to 60°C
PA-480W-DIN	480W AC-DC power Adapter(SDR-480-24) DIN-rail mount, 24V 20A, 90~264VAC/127~370VDC, Terminal Block, -20°C to 70°C
Cbl-IDC210F-DB9M-20CM	10Pin Female to DB9 Male Cable, 20CM

Nuvo-8000 Series

Intel® 9th/ 8th-Gen Core™ i7/ i5/ i3 Expansion Box-PC with up to 5 PCIe/ PCI Slots



Key Features

- Supports Intel® 9th/ 8th-Gen Core™ i7/ i5/ i3, Pentium® and Celeron® LGA1151 CPU
- Up to five expansion slots, a mixed combination of x16 PCIe, x4 PCIe, and PCI slots
- Dedicated heat dissipation for -25°C to 60°C wide-temperature operation
- 2x GbE, 4x USB 3.1 Gen1 and 5x COM ports
- Dual DVI display outputs
- Up to 2x 2.5" SATA HDD/ SSD accommodation and 1x mSATA socket
- Wall-mounting and rack-mounting available

Introduction

Nuvo-8000 series systems are cost-effective box-PCs with up to 5 expansion slots that can perfectly replace your bulky rack-mount or wall-mount IPC systems. Leveraging Intel® 9th/ 8th-Gen Core™ i desktop processor with H310 chipset, it delivers the same computing power as traditional IPCs but in a much more compact footprint with a budgetary price.

There are four models in the Nuvo-8000 series with various expansion configurations. Customers can choose from a compact 3-slot PCIe system to a 5-slot system with up to three PCIe slots or up to four PCI slots, that best suit their industrial automation or machine vision application needs. It features front-accessible I/Os including two GbE, four USB 3.1 Gen1 and five COM ports that make it easier to access when it is rack-mounted or placed inside a cabinet. Storage wise, Nuvo-8000 series systems have two 2.5" SATA SSD/ HDD and one mSATA socket to support various storage devices. The system can also support a 125W NVIDIA® GPU to offer TFLOPS computing power for modern deep-learning applications.

Nuvo-8000 series systems are designed with satisfying industrial demands in mind. Retaining traditional IPC expansion capabilities and fulfilling diverse application requirements in an extremely compact form-factor with industrial-grade reliability.

Specifications

	Nuvo-8003	Nuvo-8023	Nuvo-8032	Nuvo-8041
System Core	Supporting Intel® 9th/ 8th-Gen Core™ CPU (LGA1151 socket)			
Processor	- Intel® Core™ i7-9700TE/ i7-8700*/ i7-8700T - Intel® Core™ i5-9500TE/ i5-8500*/ i5-8500T - Intel® Core™ i3-9100TE/ i3-8100*/ i3-8100T - Intel® Pentium® G5400T (4M Cache, 3.1GHz, 35W TDP) - Intel® Celeron® G4900T (2M Cache, 2.9GHz, 35W TDP)			
Chipset	Intel® H310 platform controller hub			
Graphics	Integrated Intel® UHD Graphics 630, or independent 125W GPU via x16 PEG port			
Memory	Up to 32 GB DDR4 2666 SDRAM (one SODIMM slot)			
I/O Interface				
Ethernet	1x Gigabit Ethernet port by Intel® I219-LM 1x Gigabit Ethernet port by Intel® I210-IT			
Video Port (Integrated Graphics)	2x DVI-D connectors, each supporting 1920x1200 resolution			
Serial Port	1x software-programmable RS-232/ 422/ 485 ports (COM1) 1x software-programmable RS-422/ 485 ports (COM2) 3x 3-wire RS-232 ports (COM3/ COM4/ COM5)			
USB 3.1	4x USB 3.1 Gen1 (5 Gbps) ports			
USB 2.0	1x USB 2.0 port with Type-A connectors(internal) 2x USB 2.0 port with 2x8 pins box header(internal)			
Audio	1x 3.5 mm jack for mic-in and speaker-out			
Storage Interface				
SATA HDD	2x internal SATA ports for 2.5" HDD/ SSD installation			
mSATA	1x full-size mSATA port (SATA + USB 2.0 + USIM)			
Expansion Bus				
PCI Express	1x PCIe x16 slot @Gen3, 16-lanes 1x PCIe x8 slot @Gen2, 4-lanes 1x PCIe x4 slot @Gen2, 1-lane	1x PCIe x16 slot @Gen3, 16-lanes 1x PCIe x4 slot @Gen2, 2-lanes 1x PCIe x4 slot @Gen2, 1-lane	1x PCIe x16 slot @Gen3, 16-lanes 1x PCIe x8 slot @Gen2, 4-lanes	1x PCIe x16 slot @Gen3, 16-lanes
PCI	-	2x 33MHz/ 32-bit 5V PCI slots	3x 33MHz/ 32-bit 5V PCI slots	4x 33MHz/ 32-bit 5V PCI slots
Power Supply				
DC Input	1x 3-pin pluggable terminal block for 8 to 35V DC input			
Mechanical				
Dimension	154 mm (W) x 235 mm (D) x 174 mm (H)	185 mm (W) x 235 mm (D) x 174 mm (H)		
Weight	3 Kg	3.6 Kg		
Mounting	Wall-mount (standard) DIN-Rail mounting (optional) Rack-mount (optional)			
Environmental				
Operating Temperature	-25°C ~ 60°C			
Storage Temperature	-40°C ~ 85°C			
Humidity	10%~90% , non-condensing			
Vibration	Operating, MIL-STD-810G, Method 514.6, Category 4			
Shock	Operating, MIL-STD-810G, Method 516.6, Procedure I, Table 516.6-II			
EMC	CE/FCC Class A, according to EN55032 & EN55035			

* Due to thermal limitations, 65W CPUs will be configured to operate in 35W mode by default.

Appearance

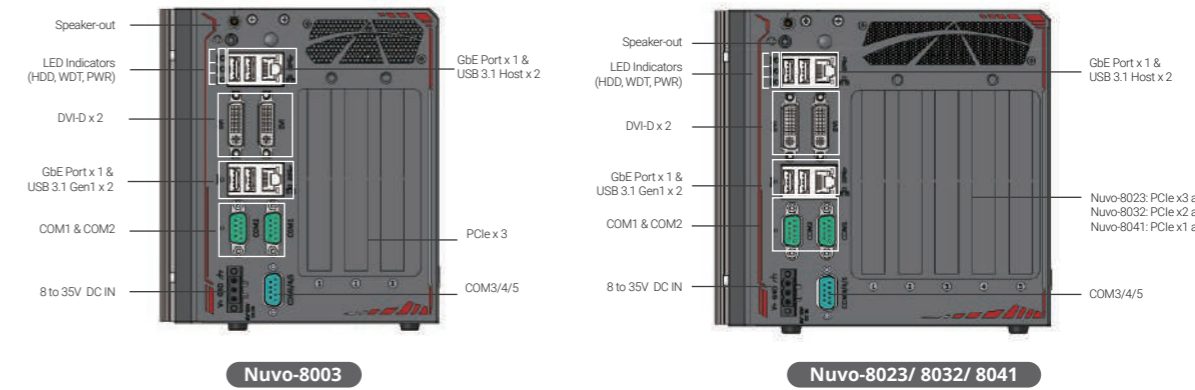

Dimensions

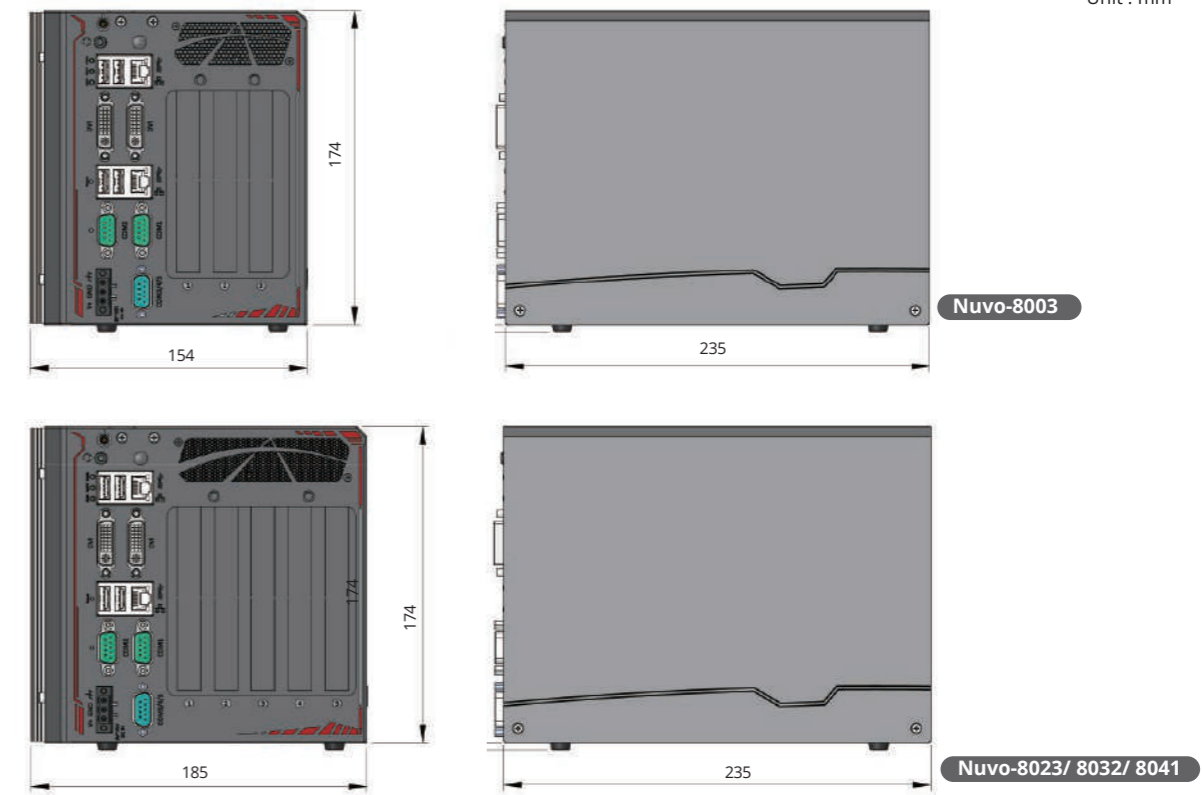

Ordering Information

Model No.	Product Description
Nuvo-8003	Intel® 9/ 8th-Gen Core™ i7/ i5/ i3 fanless rugged Box-PC with 3x PCIe expansion slots
Nuvo-8023	Intel® 9/ 8th-Gen Core™ i7/ i5/ i3 fanless rugged Box-PC with 3x PCIe and 2x PCI expansion slots
Nuvo-8032	Intel® 9/ 8th-Gen Core™ i7/ i5/ i3 fanless rugged Box-PC with 2x PCIe and 3x PCI expansion slots
Nuvo-8041	Intel® 9/ 8th-Gen Core™ i7/ i5/ i3 fanless rugged Box-PC with 1x PCIe and 4x PCI expansion slots

Optional Accessories

PA-120W-OW	120W AC/ DC power adapter 20V/ 6A; 18AWG/ 120cm; cord end terminals for terminal block, operating temperature : -30°C to 70 °C
PA-160W-OW	160W AC/DC power adapter 20V/ 8A; 18AWGx4C/ 120cm, cord end terminals for terminal block, operating temperature : -30°C to 70 °C
PA-280W-ET2	280W AC/DC power adapter 24V/ 11.67A; 16AWG/ 100cm; cord end terminals for terminal block, operating temperature : -30°C to 60°C
Fankit-92	Fan assembly for Nuvo-8000, 92x92x25 mm
Rmkit-Nuvo6000	Rack mounting assembly for Nuvo-6000/ 8000 series

Nuvo-8111 Series

Cost-effective AI Platform for Factory Automation Supporting NVIDIA® 200W GPU and Intel® 9th/ 8th-Gen Core™ Processor



CE FC

Key Features

- Intel® 9th/ 8th-Gen Core™ i7/ i5/ i3, Pentium® and Celeron® LGA1151 CPU
- Supports NVIDIA® GPU up to 200W TDP
- An additional x4 PCIe, and a PCI slot for add-on cards
- -25°C to 60°C wide-temperature operation
- 2x GbE, 4x USB 3.1 Gen1 and 5x COM ports
- Dual DVI display outputs
- Up to 2x 2.5" SATA HDD/ SSD accommodation and 1x mSATA socket

Introduction

Nuvo-8111 series is a cost-effective box-PC with 3 expansion slots designed specifically to support an advanced mid to high-end 200W NVIDIA® graphics card, such as an RTX 3060/ 3060 Ti, to offer stunning edge AI performance. Offering tremendous GPU power up to 20 TFLOPS in FP32 for emerging GPU-accelerated applications, they boost the performance and efficiency of factory automation, image recognition, product inspection, pick and place robots, etc.

Nuvo-8111 series leverages an Intel® 9th/ 8th-Gen Core™ processor with H310 chipset. It has one x16 Gen3 PCIe slot for accommodating a GPU card, and an additional x4 PCIe and a PCI slot for industrial I/O cards such as DIO, AIO, communication or motion control card. It features front-accessible I/Os including two GbE, four USB 3.1 Gen1 and five COM ports for easy access when it is rack-mounted or placed inside a cabinet. Storage-wise, the system supports two 2.5" SATA SSDs/ HDDs plus one mSATA socket to house an mSATA SSD.

As edge AI demand continues to grow for traditional production and factory automation, Neosys Nuvo-8111 seeks to fulfill this need. With mid to high-end GPU support, expansion capability, compact and rugged design that plays an important role in bringing artificial intelligence to the edge and factory floors, the Nuvo-8111 is no doubt the most cost-effective AI platform for automation in its class!

Specifications

System Core		Internal Expansion Bus	
Processor	Supporting Intel® 9th/ 8th-Gen Core™ CPU (LGA1151 socket)	PCI Express	1x PCIe x16 slot @Gen3, 16-lane (for GPU installation) 1x PCIe x4 slot @Gen2, 4-lane signal
	- Intel® Core™ i7-9700TE/ i7-8700*/ i7-8700T	PCI	1x 33MHz/ 32-bit 5V PCI slot
	- Intel® Core™ i5-9500TE/ i5-8500*/ i5-8500T	Power Supply	
	- Intel® Core™ i3-9100TE/ i3-8100*/ i3-8100T	DC Input	1x 3-pin pluggable terminal block for 24V DC input
	- Intel® Pentium® G5400T (4M Cache, 3.1GHz, 35W TDP) - Intel® Celeron® G4900T (2M Cache, 2.9GHz, 35W TDP)	Mechanical	
Chipset	Intel® H310 platform controller hub	Dimension	174 mm (W) x 330 mm (D) x 174 mm (H)
Graphics	Integrated Intel® UHD graphics 630, or independent NVIDIA® RTX 3060/ 3060 Ti via x16 PEG port	Weight	4.5 kg
Memory	Up to 32 GB DDR4 2666 SDRAM (one SODIMM slots)	Mounting	Optional wall-mount bracket
I/O Interface		Environmental	
Ethernet	1x Gigabit Ethernet port by Intel® I219-LM 1x Gigabit Ethernet port by Intel® I210-IT	Operating Temperature	-25°C to 60°C**
USB 2.0	1x USB 2.0 port with Type-A connector (internal) 2x USB 2.0 port with 2x8 pins box header (internal)	Storage Temperature	-40°C to 85°C
USB 3.1	4x USB 3.1 Gen1 (5 Gbps) ports	Humidity	10% to 90% , non-condensing
Video Port	2x DVI-D connector, supporting 1920 x 1200 resolution	Vibration	Operating, MIL-STD-810G, Method 514.6, Category 4
Serial Port	1x software-programmable RS-232/ 422/ 485 port (COM1) 1x software-programmable RS-422/ 485 port (COM2) 3x 3-wire RS-232 ports (COM3/ COM4/ COM5)	Shock	Operating, MIL-STD-810G, Method 516.6, Procedure I, Table 516.6-II
Audio	1x 3.5 mm jack for mic-in and speaker-out	EMC	CE/FCC Class A, according to EN 55032 & EN 55035
Storage Interface		* For i7-9700E and i7-8700 running at 65W mode, the highest operating temperature shall be limited to 50°C and thermal throttling may occur when sustained full-loading applied. Users can configure CPU power in BIOS to obtain higher operating temperature.	
SATA HDD	2x internal SATA ports for 2.5" HDD/ SSD installation	** For sub-zero operating temperature, a wide temperature HDD or Solid State Disk (SSD) is required.	
mSATA	1x full-size mSATA port (SATA + USB 2.0 + USIM)		

Appearance

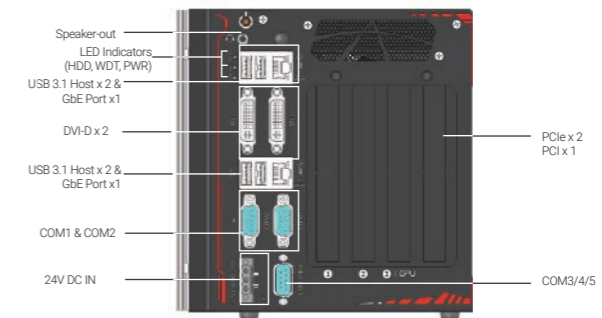

Dimensions

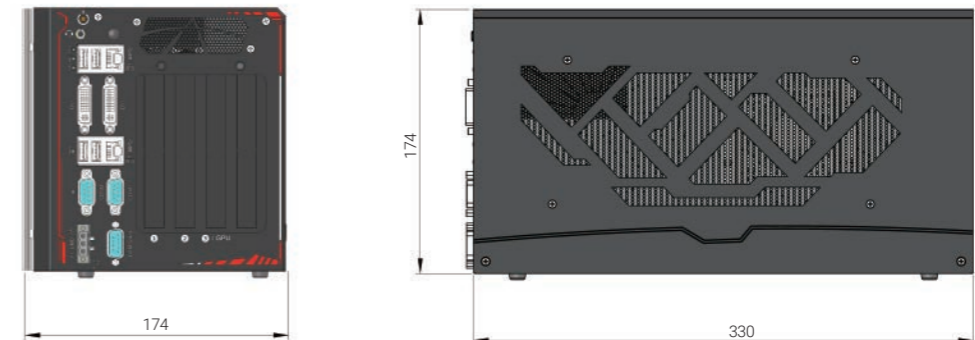

Ordering Information

Model No.	Product Description
Nuvo-8111	Intel® 9th/ 8th-Gen Core™ i7/ i5/ i3 expansion box PC with 2x PCIe and 1x PCI, supporting NVIDIA® 200W graphics card

Optional Accessories

PA-280W-ET2	280W AC/DC power adapter 24V/11.67A; 16AWG/100cm; cord end terminals for terminal block, operating temperature : -30 to 60°C
Wmkit-H-Nuvo8111	Wall mounting assembly for Nuvo-8111 series, horizontal type

Nuvo-6000 Series

Intel® 6th-Gen Core™ i7/ i5/ i3 Expansion Box-PC with Up to 5 PCIe/ PCI Slots



Key Features

- Supports Intel® 6th-Gen Core™ i7/ i5/ i3, Pentium® and Celeron® LGA1151 CPU
- Up to five expansion slots
 - x16 PCIe, x8 PCIe and three PCI slots (Nuvo-6032)
 - x16 PCIe and x8 PCIe slots (Nuvo-6002)
- Rugged, -25 °C to 60 °C fanless operation
- 2x GbE, 4x USB 3.1 and 5x COM ports
- Dual DVI display outputs
- Up to 3x 2.5" SATA HDD/SDD and 1x mSATA socket
- Wall-mounting, (optional DIN-rail and rack-mount)
- Optional fan with automatic temperature sensing and fan control

Introduction

Nuvo-6000 series is the perfect replacement of your bulky rack-mount or wall-mount IPC systems. Leveraging Intel® 6th-Gen Skylake platform, It delivers the same computing power as traditional IPCs, but in a more compact form-factor and fanless operation.

Nuvo-6000 Series has up to 5-slot capacity that gives the same level of expandability as most IPCs. With different PCIe and PCI combination from 2 PCIe slots to 5 PCIe/PCI slots, Nuvo-6000 Series makes up four models for customers to choose. There must be one that best meets your industrial automation or machine vision application needs.

Nuvo-6000 series supports LGA1151 socket-type CPU, thus you can choose from Core™ i7 to Celeron® depending on your performance and cost consideration. The front-accessible I/O design, including 2 GbE, 4 USB 3.1 Gen1 and 5 COM ports, makes it easier to access your Nuvo-6000 when it's placed inside a cabinet or a rack.

Neosys' proven fanless design on Nuvo-6000 presents extraordinary reliability in all circumstances. And its versatile mounting options make it fit for desktop, cabinet or a 19" rack. With similar performance and cost, better form-factor and reliability, Nuvo-6000 series is speaking for itself on the new horizon of industrial computer.

Specifications

	Nuvo-6002	Nuvo-6032	Nuvo-6023	Nuvo-6041
System Core				
Processor	Supports Intel® 6th-Gen Core™, Pentium® and Celeron® LGA1151 CPU Intel® Core™ i7-6700TE (8M Cache, 2.4/ 3.4 GHz, 35W TDP) Intel® Core™ i5-6500TE (6M Cache, 2.3/ 3.3 GHz, 35W TDP) Intel® Core™ i3-6100TE (4M Cache, 2.7 GHz, 35W TDP) Intel® Pentium® G4400TE (3M Cache, 2.4 GHz, 35W TDP) Intel® Celeron® G3900TE (2M Cache, 2.3 GHz, 35W TDP)			
Chipset	Intel® H110 platform controller hub			
Graphics	Integrated Intel® HD 530/ 510 controller			
Memory	Up to 16 GB DDR4-2133 (single SODIMM slot)			
I/O Interface				
Ethernet	1x Gigabit Ethernet port by Intel® I219-LM 1x Gigabit Ethernet port by Intel® I210-IT			
Video Port	2x DVI-Ds for DVI outputs, supporting 1920x1200 resolution			
Serial Port	1x software-programmable RS-232/ 422/ 485 ports (COM1) 1x software-programmable RS-422/ 485 ports (COM2) 3x 3-wire RS-232 ports (COM3/ COM4/ COM5)			
USB 3.1	4x USB 3.1 Gen1 (5 Gbps) ports			
Audio	1x Speaker-out			
Storage Interface				
SATA HDD	1x SATA port for 2.5" HDD/ SSD installation	3x SATA ports for 2.5" HDD/ SSD installation		
mSATA	1x full-size mSATA port (mux with mini-PCIe)			
Expansion Bus				
PCI Express	1x PCIe x16 slot @ Gen3, 16-lanes 1x PCIe x8 slot @ Gen2, 4-lanes	1x PCIe x16 slot @ Gen3, 16-lanes 1x PCIe x8 slot @ Gen2, 4-lanes	1x PCIe x16 slot @ Gen3, 16-lanes 1x PCIe x4 slots @ Gen2, 2-lanes 1x PCIe x4 slots @ Gen2, 1-lane	1x PCIe x16 slot @ Gen3, 16-lanes
PCI	-	3x 33MHz/ 32-bit 5V PCI slots	2x 33MHz/ 32-bit 5V PCI slots	4x 33MHz/ 32-bit 5V PCI slots
mSATA	1x full-size mSATA socket (mux with USB 2.0 signals)			
Power Supply				
DC Input	1x 3-pin pluggable terminal block for 8 to 35V DC input			
Mechanical				
Dimension	124 mm (W) x 225 mm (D) x 174 mm (H)	184 mm (W) x 225 mm (D) x 174 mm (H)		
Weight	2.8 Kg	3.5 Kg		
Mounting	Wall-mount (standard), DIN-rail mount (optional) or Rack-mount (optional)			
Environmental				
Operating Temperature	-25°C ~ 60°C			
Storage Temperature	-40°C ~ 85°C			
Humidity	10%~90% , non-condensing			
Vibration	Operating, 5 Grms, 5-500 Hz, 3 Axes (w/ SSD, according to IEC60068-2-64)		Operating, MIL-STD-810G, Method 514.6, Category 4	
Shock	Operating, 50 Grms, Half-sine 11 ms Duration (w/ SSD, according to IEC60068-2-27)		Operating, MIL-STD-810G, Method 516.6, Procedure I, Table 516.6-II	
EMC	CE/FCC Class A, according to EN 55022, EN 55024 & EN 55032		CE/FCC Class A, according to EN55032 & EN55035	

* For i7-6700 running at 65W mode, the highest operating temperature shall be limited to 50°C and thermal throttling may occur when sustained full-loading applied. Users can configure CPU power in BIOS to obtain higher operating temperature.
** For sub-zero operating temperature, a wide temperature HDD drive or Solid State Disk (SSD) is required.

Appearance

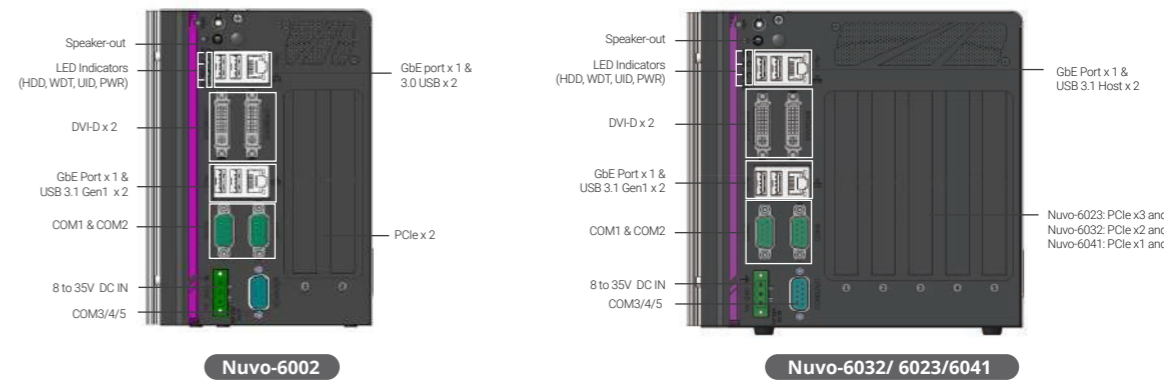

Dimensions

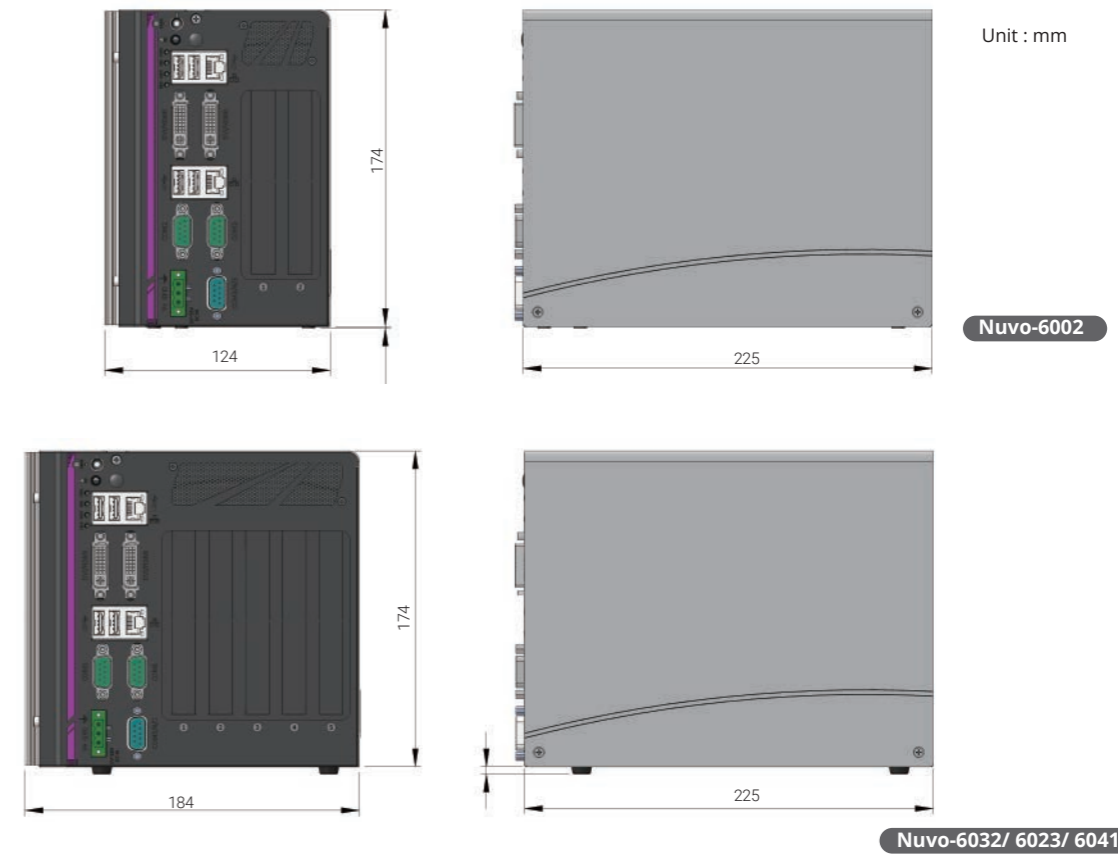

Ordering Information

Model No.	Product Description
Nuvo-6002	Intel® 6th-Gen Core™ fanless Box-PC with 1x PCIe x16 slot and 1x PCIe x8 (@ x4 signals) slot
Nuvo-6032	Intel® 6th-Gen Core™ fanless Box-PC with 1x PCIe x16 slot, 1x PCIe x8 (@ x4 signals) slot and 3x PCI slots
Nuvo-6023	Intel® 6th-Gen Core™ fanless Box-PC with 3x PCIe slot and 2x PCI slots
Nuvo-6041	Intel® 6th-Gen Core™ fanless Box-PC with 1x PCIe and 4x PCI slots

Optional Accessories

PA-120W-OW	120W AC/ DC power adapter 20V/ 6A; 18AWG/ 120cm; cord end terminals for terminal block, operating temperature : -30°C to 70 °C
PA-160W-OW	160W AC/DC power adapter 20V/ 8A; 18AWGx4C/ 120cm, cord end terminals for terminal block, operating temperature : -30°C to 70 °C
Fankit-80	Fan assembly for Nuvo-6000 series, 80x80x15 mm
Cbl-DB9F-3DB9M-15CM	1x DB9 (female) to 3x DB9 (male), for Nuvo-6000 series, length: 15CM
DINRAIL-E	DIN-rail mount assembly for Nuvo-6000 series
Rmkit-Nuvo6000	Rack mounting assembly for Nuvo-6000/ 8000 series

Nuvo-2700DS Series

AMD Ryzen™ V1000 Rugged 4x 4K Interactive Digital Signage System Supporting 2x Google Edge TPU

Key Features

- AMD Ryzen™ embedded V1605B series quad-core 15W CPU
- Rugged -25°C to 70°C fanless operation
- 4x 4K DP display, 3840 x 2160 resolution per output
- AI inference capability by 2x optional Edge TPU
- 1x M.2 3042/3052 B-Key for 4G/5G module
- 2x USB3.1 Gen 1 and 2x USB2.0
- 8V to 35V wide-range DC input with built-in ignition power control
- Flexible power input options: mini-DIN or terminal block



Introduction

Nuvo-2700DS series is a rugged digital signage system with AI inference capability for personalized user experience and audience measurement. Powered by AMD Ryzen™ Embedded V1605B, it can output to four 4K displays and playback 4K H.265 videos at 60fps. By supporting two Google Edge TPUs, it delivers a total of 8 TOPS AI inference performance in a fanless compact form factor.

The wide operating temperature and fanless design make it ideal for 24/7 applications in harsh indoor and outdoor environments, such as flight information display system (FIDS) or train schedule board. Furthermore, Nuvo-2700DS can also be deployed for mobile applications due to the inclusion of ignition power control and full bandwidth support of WIFI 6, 4G LTE, and 5G network modules.

The support of two Google Edge TPUs empower Nuvo-2700DS as a smart digital signage player to leverage real-time camera input and AI computer vision models (e.g., YOLO-lite or PoseNet) to offer audiences an interactive and personalized experience. Besides, it can get to know its audience by collecting anonymous data from people counting, body gesture recognition, facial recognition, attention measurement, and emotion analysis.

The Nuvo-2700DS series signifies a new age of AI enabled digital signage player for harsh environments and mobile applications. You can utilize Nuvo-2700DS as a video wall player to playback to 4K ultra high definition visual displays or deploy Nuvo-2700DS as a low power fanless Edge AI platform for emerging AI applications. With AI inference from Google Edge TPUs, Nuvo-2700DS creates an interactive and personalized experience, but moreover, it can quantify offline campaign like never before and offer insight data.

Specifications

System Core		Power Supply	
Processor	AMD Ryzen™ Embedded V1605B CPU (4C/ 8T, 2M Cache, 2.0/ 3.6 GHz, 12W - 25W TDP)	DC Input	1x mini-DIN for 12V DC input or 1x 3-pin pluggable terminal block for 8 to 35V DC input (IGN/ GND/ V+)
Graphics	Vega GPU with 8 compute units	Mechanical	
Memory	Up to 64 GB DDR4-2400 SDRAM by two SODIMM sockets	Dimension	173 mm (W) x 174 mm (D) x 50 mm (H)
Panel I/O Interface		Weight	1.6 kg
Video Port	4x DisplayPort, supporting 4K UHD resolution	Mounting	Wall-mount (optional)
Ethernet Port	2x Gigabit Ethernet ports by 2x Intel I210® controller	Environmental	
USB 3.1	2x USB 3.1 Gen1 (5 Gbps) ports	Operating Temperature	-25°C ~ 70°C
USB 2.0	2x USB 2.0	Storage Temperature	-40°C ~ 85°C
Audio	1x 3.5mm jack for mic-in and line-out	Humidity	10% ~ 90%, non-condensing
Serial Port	2x RS-232 (COM1 in DB9, COM2 in RJ50)	Vibration	Operating, MIL-STD-810G, Method 514.7, Category 4
DIO	4-CH isolated DI and 4-CH isolated DO (optional)	Shock	Operating, MIL-STD-810G, Method 516.7, Procedure I
Internal I/O Interface		EMC	CE/FCC Class A, according to EN 55032 & EN 55035
Mini PCI Express	2x half-size mini PCI Express socket for Google Edge TPU	<small>* For sub-zero and over 60°C operating temperature, a wide temperature HDD or Solid State Disk (SSD) is required.</small>	
M.2	1x M.2 3042/ 3052 B key (USB 3.1 Gen 1 + USB 2.0) for 4G/ 5G module with Micro SIM card slot 1x M.2 2230 E key (PCIe Gen3 x1 + USB 2.0) for WIFI module	Storage Interface	
M.2 SATA	1x M.2 2280 M key (SATA signal only) socket for SATA SSD installation		

Appearance

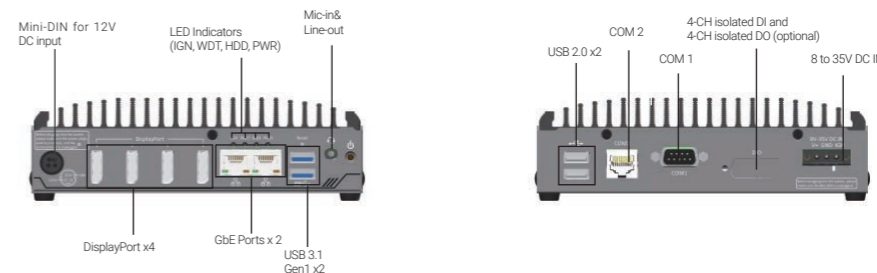

Dimensions

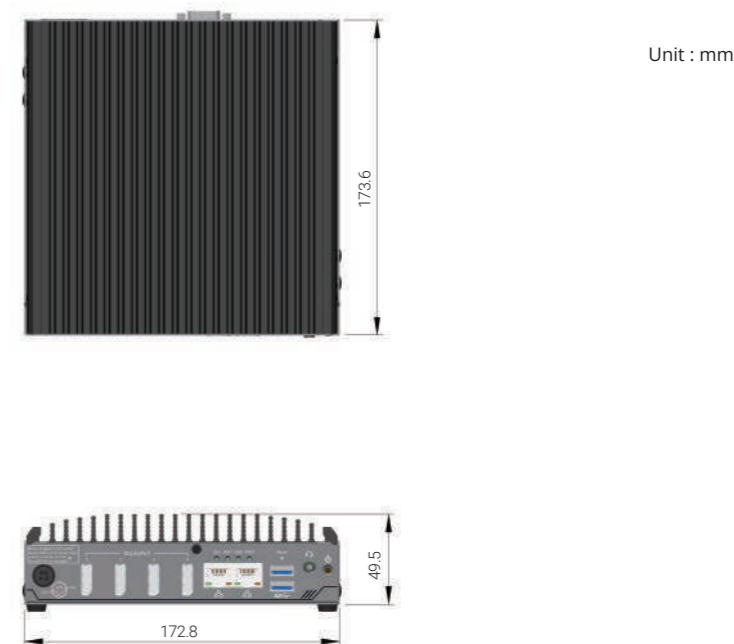

Ordering Information

Model No.	Product Description
Nuvo-2700DS	AMD Ryzen™ Embedded V1000 rugged 4x 4K interactive digital signage system
Nuvo-2700DS-1TU	AMD Ryzen™ Embedded V1000 rugged 4x 4K interactive digital signage system with 1x Google Edge TPU
Nuvo-2700DS-2TU	AMD Ryzen™ Embedded V1000 rugged 4x 4K interactive digital signage system with 2x Google Edge TPU

Optional Accessories

Wmkit-V-Nuvo2700DS	Wall mounting assembly for Nuvo-2700DS series, vertical type
Cbl-IDC216F-DB15M-4.5CM	DIO Flat Cable to DB15 male cable, for Nuvo-2700DS, Length: 4.5CM
PA-60W-OW	60W AC/DC power adapter 12V/5A; cord end terminals for terminal block, operating temperature: -30 to 60 °C.
PA-120W-OW	120W AC/DC power adapter 20V/6A; 18AWG/120cm; cord end terminals for terminal block, operating temperature: -30 to 70 °C.
PA-120W	120W AC/DC power adapter 12V/8.5A (max. output 120W); 18AWG/120cm; DIN 4PIN connector, operating Temperature: -30 to 70 °C.

POC-700 Series

Intel® Core™ i3-N305 Ultra-Compact Embedded Controller with 4x PoE+, 4x USB 3.2 and MezIO® Interface



Key Features

- Intel® Alder Lake Core™ i3-N305 processor 15W with 8 E-Cores
- Up to 16GB DDR5-4800 SODIMM
- -25 °C to 70 °C rugged wide temperature operation
- 4x GbE ports PoE+ / 4x USB3.2 Gen 2 with screw-lock
- M.2 2280 M key SATA socket
- Dual DP++ / HDMI 1.4b dual display outputs
- 4-CH isolated DI + 4-CH isolated DO
- Front I/O access DIN-mounting design
- MezIO® compatible



Preliminary

Introduction

POC-700 is Neosys' next-generation ultra-compact embedded controller utilizing the latest Intel® Alder Lake i3-N305 processor that is capable of delivering up to 1.3x the CPU performance when compared to previous POC-500 series.

Neosys POC-700 is powered by Intel's Alder Lake i3-N305, an 8-core/ 8-thread processor, coupled with Intel's UHD Graphics with 32EUs to support Intel® OpenVINO™ for AI inference capabilities. The system adopts DDR5-4800 to offer up to 1.8x the memory bandwidth over DDR4 to boost overall system performance. It also has four USB3.2 Gen2, and four GigE PoE+ ports with screw lock mechanisms to connect and secure industrial cameras for machine vision applications. Display output wise, there are HDMI and DP video outputs to support high-definition display devices. As for connections and expansions, POC-700 features isolated DIO for device monitoring/control, M.2 2280 M key for SATA SSD and a mini-PCIe socket for wireless WiFi, LTE/5G or CAN bus device.

Measuring just 64 x 116 x 176mm, the ultra-compact POC-700 can easily fit into restricted space and is a seamless upgrade from POC-500 series with identical footprint. Benefiting from the performance gains of the latest Intel® i3-N305 CPU, wide-temperature fanless design, and ample interfaces for industrial cameras and I/Os, POC-700 is perfect for machine vision and smart city applications.

Specifications

System Core		Power Supply	
Processor	Intel® Alder Lake Core™ i3-N305 processor (8C/8T, 1.8/3.8 GHz, 15W TDP)	DC Input	1x 3-pin pluggable terminal block for 8 to 35V DC input
Graphics	Integrated Intel® HD Graphics with 32EUs	Remote Ctrl. & LED Output	1x 3-pin pluggable terminal block for remote control and PWR LED output
Memory	Up to 16 GB DDR5-4800 SDRAM (one SODIMM socket)	Mechanical	
TPM	Supports TPM 2.0 (fTPM/ dTPM)	Dimension	64 (W) x 116 (D) x 176 (H) mm
Panel I/O Interface		Weight	1.2 kg
Ethernet	4x Gb Ethernet ports by Intel® I350-AM4	Mounting	DIN-rail mount (standard) or wall-mount (optional)
PoE+	IEEE 802.3at PoE+ on port #1-4, 100 W total power budget	Environmental	
Native Video Port	1x DP++, Supporting 4096 x 2160 resolution 1x HDMI1.4b, Supporting 3840 x 2160 30Hz resolution	Operating Temperature	-25°C ~ 70°C
Serial Port	1x Software-programmable RS-232/422/485 ports (COM1) 3x 3-wire RS-232 ports (COM2/3/4) or 1x RS-422/485 port (COM2)	Storage Temperature	-40°C ~ 85°C
USB	4x USB 3.2 Gen2 ports with screw-lock	Humidity	10%~90% , non-condensing
Isolated DIO	4-CH isolated DI and 4-CH isolated DO	Vibration	Operating, MIL-STD-810G, Method 514.6, Category 4
Storage Interface		Shock	Operating, MIL-STD-810G, Method 516.6, Procedure I, Table 516.6-II
M.2	1x M.2 2280 SATA interface	Safety	EN62368-1
Expansion Bus		EMC	CE/FCC Class A, according to EN 55032 & EN 55035
Mini-PCIe	1x full-size mini PCI Express socket with internal micro SIM socket		
Expandable I/O	1x MezIO® expansion interface for Neosys MezIO® modules		

Appearance

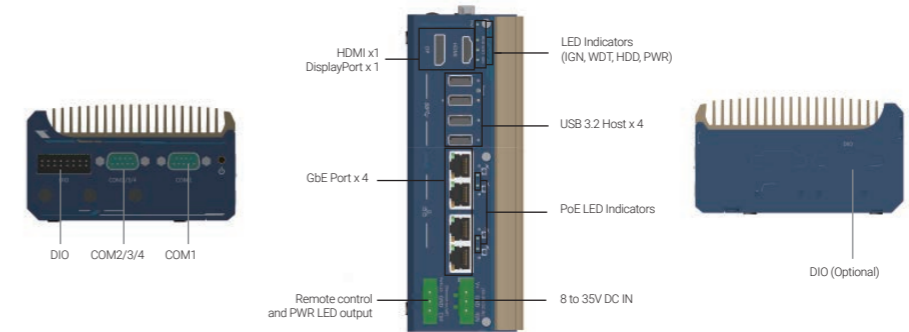

Dimensions

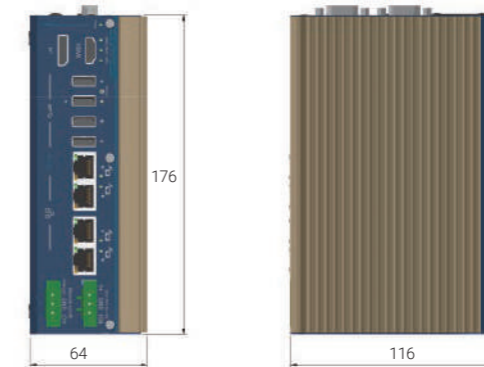

Ordering Information

Model No.	Product Description
POC-700	Intel® Core™ i3-N305 Ultra-Compact Embedded Controller with 4x PoE+, 4x USB 3.2 and MezIO® Interface

Optional Accessories

PA-60W-OW	60W AC/DC power adapter with 12V, 5A DC output, cord end terminals for terminal block. Operating temperature : -30 to 70°C
PA-120W-OW	120W AC/DC power adapter with 12V, 10A DC output, cord end terminals for terminal block. Operating temperature : -30 to 60°C
Wmkit-V-POC700	Wall-mount assembly for POC-700 series, vertical type
Wmkit-H-POC700	Wall-mount assembly for POC-700 series, horizontal type
Cbl-DB9F-3DB9M-15CM	1x DB9 (Female) to 3x DB9 (Male), length: 15CM
MezIO® Modules	
MezIO®-C180	MezIO® module with 4x RS-232/ 422/ 485 ports and 4x RS-232 ports
MezIO®-C181	MezIO® module with 4x RS-232/ 422/ 485 ports and 4x RS-422/ 485 ports
MezIO®-V20	MezIO® module with ignition power control function and 1x mini-PCIe socket for in-vehicle usage
MezIO®-U4	MezIO® module with 4x USB 3.1 ports
MezIO®-R11	MezIO® module with SATA port for 2.5" HDD/ SSD
MezIO®-R12	MezIO® module with SATA port for 2.5" HDD/ SSD, 4-CH isolated DI and 4-CH isolated DO

POC-500 Series

AMD Ryzen™ V1000 Ultra-compact Embedded Controller with 4x PoE+, 4x USB 3.1 and MezIO® Interface

Key Features

- AMD Ryzen™ embedded V1000 series quad-core 15W/ 45W CPU
- -25 °C to 70 °C rugged wide temperature operation
- Four Gigabit PoE+ ports with screw-lock
- Four USB 3.1 ports with screw-lock
- M.2 2280 M key NVMe (Gen3 x2) socket for fast storage access
- DP + VGA dual display outputs
- Front I/O access and DIN-rail mount design
- MezIO® compatible

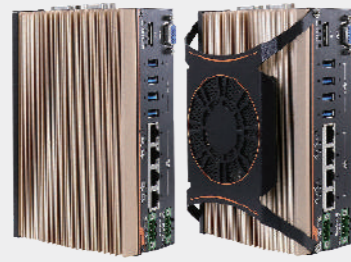

POC-515

POC-545



Introduction

POC-500 series is the next generation ultra-compact embedded controller offering performances never-seen-before in this form factor. Featuring AMD Ryzen™ Embedded V1000 4-core/ 8-thread processor, it delivers up to 3x times the CPU performance over previous POC series. GPU performance wise, it delivers an unheard of 3.6 TFLOPS in FP16 for an ultra-compact form factor embedded controller. Another amazing feat is that it manages to incorporate an M.2 2280 NVMe SSD (PCIe Gen3 x2) to support 2x times the disk read/ write speed over typical 2.5" SATA SSDs.

POC-500 series continues the POC series ingenious DIN-rail mount mechanical design and offers plenty of front-accessible I/Os. Measuring just 64 x 176 x 116 mm (2.5" x 6.9" x 4.6"), it has 4x PoE+ ports, 4x USB 3.1 ports and 4x COM ports. And best of all, all data ports come with screw-lock mechanism so you can be rest assured that cables are always secured. POC-500 series is available in two CPU variants, the V1807B (45W) variant is for high computing power demand and the V1605B (15W) variant is designed for rugged fanless operation.

The arrival of POC-500 series signifies a new breed of ultra-compact embedded controller; one with better I/O design, extraordinary ruggedness and significantly more CPU/ GPU oomph for versatile applications.

Specifications



	POC-515	POC-545
System Core		
Processor	AMD Ryzen™ V1605B CPU (4C/ 8T, 2M Cache, 2.0/ 3.6 GHz, 12W - 25W TDP)	AMD Ryzen™ V1807B CPU (4C/ 8T, 2M Cache, 3.35/ 3.8 GHz, 35W - 54W TDP)
Graphics	Vega GPU with 8 compute units	Vega GPU with 11 compute units
Memory	Up to 32 GB DDR4-2400 SDRAM by one SODIMM socket	Up to 32 GB DDR4-3200 SDRAM by one SODIMM socket
TPM	Supports TPM 2.0	
Panel I/O Interface		
Ethernet	4x Gb Ethernet ports by Intel® I350-AM4	
PoE+	IEEE 802.3at PoE+ on port #1~ 4 100 W total power budget	
USB 3.1	4x USB 3.1 Gen1 (5 Gbps) ports with screw-lock	
Video Port	1x VGA , supporting 1920 x 1200 resolution 1x DisplayPort, supporting 4096 x 2160 resolution	
Serial Port	1x software-programmable RS-232/ 422/ 485 ports (COM1) 3x 3-wire RS-232 ports (COM2/ 3/ 4) or 1x RS-422/ 485 port (COM2)	
Audio	1x 3.5mm jack for mic-in and speaker-out	
Internal I/O Interface		
Mini-PCIe	1x full-size mini PCI Express socket with internal SIM socket	
Expandable I/O	1x MezIO® expansion interface for Neousys MezIO® modules	
Storage Interface		
M.2 NVMe	1x M.2 2280 M key NVMe socket (PCIe Gen3 x2) for NVMe SSD installation	
Power Supply		
DC Input	1x 3-pin pluggable terminal block for 8 to 35V DC input	
Remote Ctrl.&LED Output	1x3-pin pluggable terminal block for remote control and PWR LED output	
Mechanical		
Dimension	64 (W) x 116 (D) x 176 (H) mm	82 (W) x 118 (D) x 176 (H) mm
Weight	1.2 kg	1.4 kg
Mounting	DIN-rail mount (standard) or Wall-mount (optional)	
Fan	-	External-accessible 80mm x 80mm fan for system heat dissipation
Environmental		
Operating Temperature	-25°C ~ 70°C*/**	
Storage Temperature	-40°C ~ 85°C	
Humidity	10%~90% , non-condensing	
Vibration	Operating, MIL-STD-810G, Method 514.6, Category 4	
Shock	Operating, MIL-STD-810G, Method 516.6, Procedure I, Table 516.6-II	
Safety	EN62368-1	
EMC	CE/ FCC Class A, according to EN 55032 & EN 55024	

* For sub-zero and over 60°C operating temperature, a wide temperature HDD or Solid State Disk (SSD) is required.
** For POC-545, operating temperature is up to 70°C only if external-accessible fan is installed.

Appearance

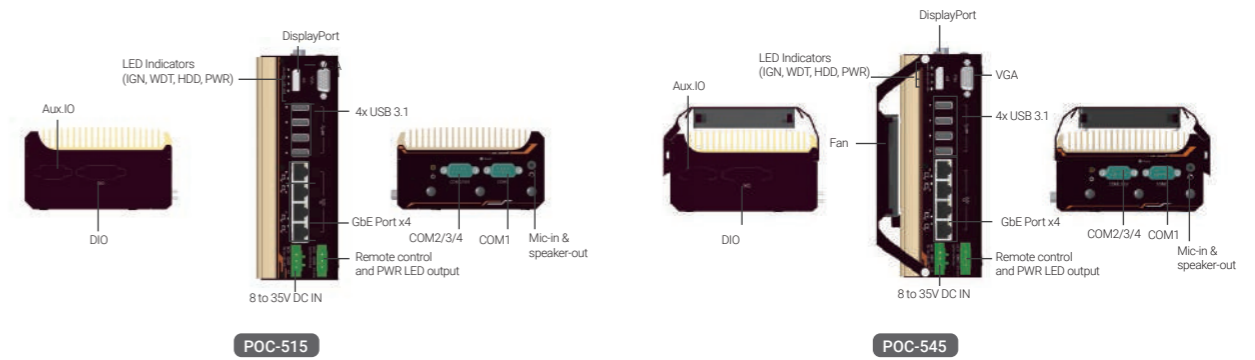

Dimensions

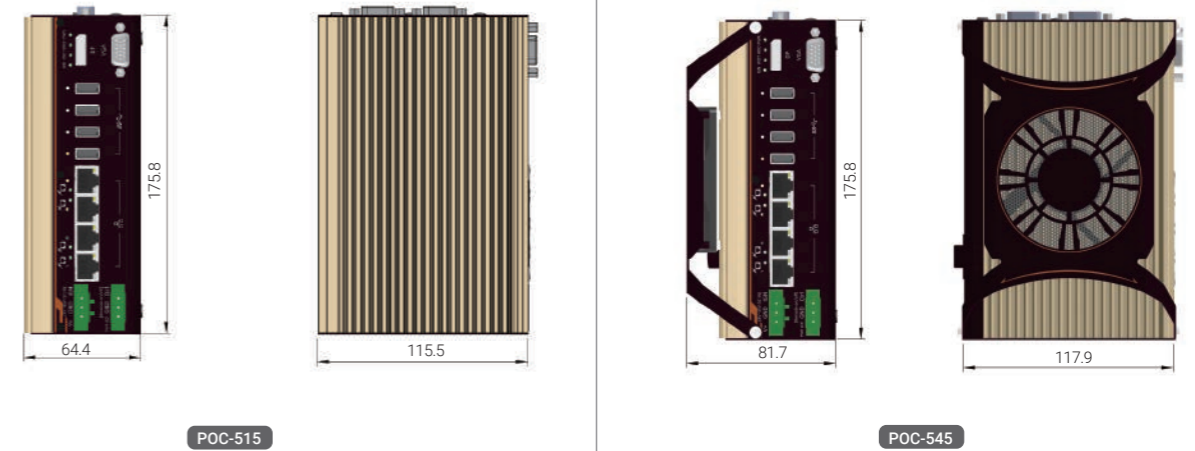

Ordering Information

Model No.	Product Description
POC-515	AMD Ryzen™ V1605B ultra-compact embedded controller with 4x PoE+ ports, 4x USB 3.1 ports and MezIO® interface
POC-516	AMD Ryzen™ V1605B ultra-compact embedded controller with 4x PoE+ ports, 4x USB 3.1 ports and MezIO®-R12
POC-545	AMD Ryzen™ V1807B ultra-compact embedded controller with 4x PoE+ ports, 4x USB 3.1 ports and MezIO® interface
POC-546	AMD Ryzen™ V1807B ultra-compact embedded controller with 4x PoE+ ports, 4x USB 3.1 ports and MezIO®-R12

Optional Accessories

PA-120W-OW	120W AC/DC power adapter 20V/6A; 18AWG/120cm; cord end terminals for terminal block, operating temperature : -30 to 70 °C.
PA-60W-OW	60W AC/DC power adapter with 12V, 5A DC output, cord end terminals for terminal block. operating temperature : -30 to 60 °C.
Cbl-DB9F-3DB9M-15CM	1x DB9 (Female) to 3x DB9 (Male), length: 15CM
MezIO® Modules	
MezIO®-C180	MezIO® module with 4x RS-232/ 422/ 485 ports and 4x RS-232 ports
MezIO®-C181	MezIO® module with 4x RS-232/ 422/ 485 ports and 4x RS-422/ 485 ports
MezIO®-D220	MezIO® module with 8-CH isolated digital input and 8-CH isolated digital output
MezIO®-D230	MezIO® module with 16-CH isolated digital input and 16-CH isolated digital output
MezIO®-V20	MezIO® module with ignition power control function and 1x mini-PCIe socket for in-vehicle usage
MezIO®-U4	MezIO® module with 4x USB 3.1 ports
MezIO®-G4	MezIO® module with 4x GigE ports
MezIO®-R11	MezIO® module with SATA port for 2.5" HDD/ SSD
MezIO®-R12	MezIO® module with SATA port for 2.5" HDD/ SSD, 4-CH isolated DI and 4-CH isolated DO

POC-400 Series

Intel® Elkhart Lake Atom® x6425E Ultra-compact Fanless Embedded Computer with 2.5GbE & PoE+

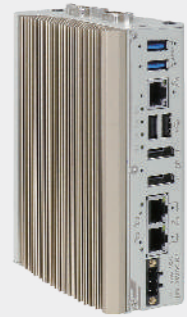

Key Features

- Intel® Elkhart Lake Atom® x6425E quad-core 2.0GHz/ 3.0GHz 12W processor
- Rugged -25 °C to 70 °C fanless operation
- 2x 2.5GbE PoE+ ports and 1x 2.5GbE port with screw-lock
- 2x USB 3.1 Gen1 and 2x USB 2.0 ports with screw-lock
- M.2 2280 M key SATA interface
- Dual DP display outputs supporting 4096 x 2160 resolution
- Front I/O access DIN-mounting design
- MeziO® compatible

Introduction

POC-400 is an ultra-compact fanless embedded computer for industrial applications. It utilizes the latest Intel® Elkhart Lake platform Atom® x6425E 4-core CPU that can deliver 1.8x CPU and 2x GPU performance improvement, compared to the previous generation.

In addition to the performance boost, POC-400 features an ultra-compact design measuring just 56 x 108 x 153 mm, which can easily fit into restricted spaces. The system comes with a DIN-rail mounting chassis and an abundance of front-access I/O interfaces. Featuring three 2.5GBASE-T Ethernet ports with IEEE 802.3 PoE+ capability, they provide higher data bandwidth for devices such as NBASE-T cameras and is backward-compatible with 1000/100/10 Mbps Ethernet. It also has two 4K DisplayPort, 2x USB3.1 Gen1, 2x USB 2.0 and COM ports for general industrial applications.

Supporting Neosys' proprietary MeziO® interface for function expansion, you can add functions such as isolated DIO, RS-232/422/485, ignition control and 4G/ 5G by installing a MeziO® module. Moreover, POC-400 comes with an internal M.2 E key socket for a Google TPU or an Intel® Movidius VPU module to transform it into a lightweight AI inference platform at the edge.

Combining the new 10nm Atom® CPU, 2.5G Ethernet ports, PoE+ and ultra-compact enclosure with function expansion capabilities, Neosys' POC-400 is a compact and yet versatile embedded computer that can fuel various industrial applications.

Specifications

System Core		Storage Interface	
Processor	Intel® Elkhart Lake Atom® x6425E quad-core 2.0GHz/3.0GHz 12W processor	M.2 M key	1x M.2 2280 SATA interface
Graphics	Integrated Intel® UHD Graphics	Power Supply	
Memory	Up to 32 GB DDR4-3200 SDRAM by one SODIMM socket	DC Input	1x 3-pin pluggable terminal block for 8 to 35V DC input
TPM	Supports fTPM 2.0	Mechanical	
Panel I/O Interface		Dimension	56 mm (W) x 108 mm (D) x 153 mm (H)
Ethernet	3x 2.5GBASE-T Ethernet ports by Intel® I225 GbE controllers	Weight	0.96 kg
PoE	Optional IEEE 802.3at PoE+ on port #2 and #3, 50 W total power budget	Mounting	DIN-rail mount (standard) or Wall-mount (optional)
Video Port	2x DisplayPort connector, supporting 4096 x 2160 resolution @ 60Hz	Environmental	
USB 3.1	2x USB 3.1 Gen1 (5 Gbps) ports	Operating Temperature	-25°C – 70°C*/**
USB 2.0	2x USB 2.0 ports	Storage Temperature	-40°C – 85°C
Serial Port	1x software-programmable RS-232/422/485 ports (COM1) 3x 3-wire RS-232 ports (COM2/3/4) or 1x RS-422/485 port (COM2)	Humidity	10%~90% , non-condensing
Audio	1x 3.5 mm jack for mic-in and speaker-out	Vibration	Operating, MIL-STD-810G, Method 514.7, Category 4
Internal Expansion Bus		Shock	Operating, MIL-STD-810G, Method 516.7, Procedure I
M.2 E key	1x M.2 2230 E key socket for WiFi, Google TPU or Movidius VPU module	EMC	CE/FCC Class A, according to EN 55032 & EN 55035
Expandable I/O	1x MeziO® expansion port for Neosys MeziO® modules	<small>* The 100% CPU/GPU loading for high temperature test is applied using Passmark® BurnInTest™ v8.0. For detail testing criteria, please contact Neosys Technology</small> <small>** For sub-zero operating temperature, a wide temperature HDD drive or Solid State Disk (SSD) is required.</small>	

Appearance

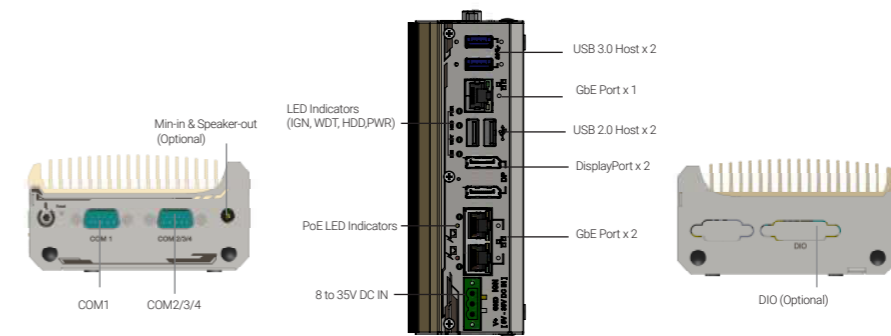

Dimensions

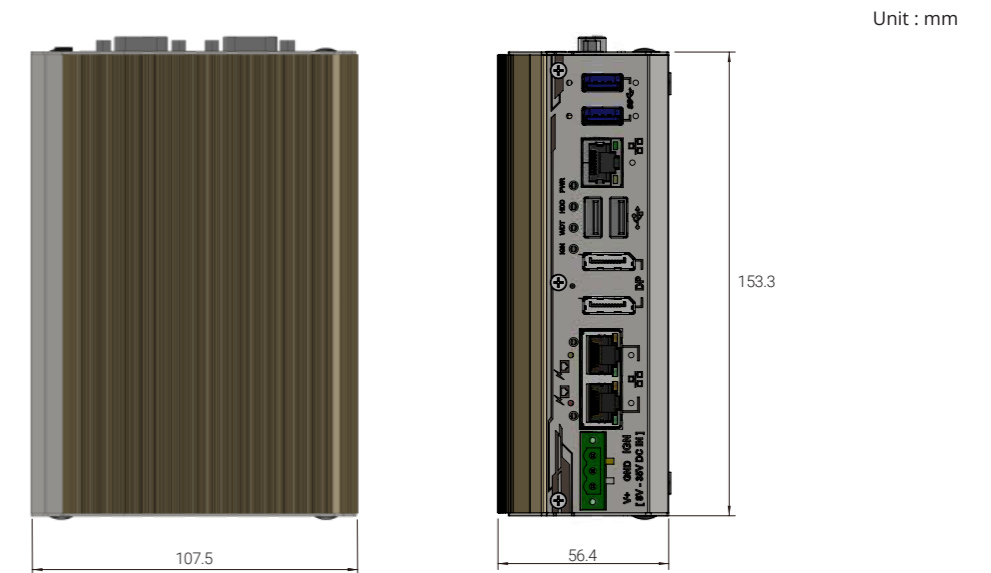

Ordering Information

Model No.	Product Description
POC-400	Intel® Elkhart Lake Atom® x6425E ultra-compact DIN-rail fanless rugged computer with 1x 2.5GbE, 2x 2.5G PoE+ and 2x USB 3.1 Gen1
POC-410	Intel® Elkhart Lake Atom® x6425E ultra-compact DIN-rail fanless rugged computer with 3x 2.5GbE and 2x USB 3.1 Gen1

Optional 1x 3.5 mm jack for mic-in and speaker-out

Optional Accessories

PA-60W-OW	60W AC/DC power adapter with 12V, 5A DC output, cord end terminals for terminal block. Operating temperature : -30 to 60 °C
Wmkit-V-POC400	Wall-mount assembly for POC-400 series, vertical type
Wmkit-H-POC400	Wall-mount assembly for POC-400 series, horizontal type
Cbl-DB9F-3DB9M-15CM	1x DB9 (Female) to 3x DB9 (Male), length: 15CM
MeziO® Modules	
MeziO®-C180	MeziO® module with 4x RS-232/ 422/ 485 ports and 4x RS-232 ports
MeziO®-C181	MeziO® module with 4x RS-232/ 422/ 485 ports and 4x RS-422/ 485 ports
MeziO®-D220	MeziO® module with 8-CH isolated digital input and 8-CH isolated digital output
MeziO®-D230	MeziO® module with 16-CH isolated digital input and 16-CH isolated digital output
MeziO®-V20	MeziO® module with ignition power control function and 1x mini-PCIe socket for in-vehicle usage
MeziO®-U4	MeziO® module with 4x USB 3.1 ports
MeziO®-R11	MeziO® module with SATA port for 2.5" HDD/ SSD
MeziO®-R12	MeziO® module with SATA port for 2.5" HDD/ SSD, 4-CH isolated DI and 4-CH isolated DO

POC-40

Intel® Elkhart Lake Atom® x6211E Extreme-compact Embedded Computer with 2x GbE and 2x USB 3.1



CE FC

Key Features

- Intel® Elkhart Lake Atom® x6211E dual-core processor
- 52 x 89 x 112 mm extremely compact form factor
- Rugged -25°C to 70°C fanless wide-temperature operation
- Two GigE ports, two USB 3.1 Gen1 ports and two USB2.0 ports
- M.2 2280 M key SATA storage interface
- One M.2 B key socket supporting 5G/ 4G 3042/ 3052 modules
- One M.2 E key socket for WiFi 5/ WiFi 6 modules
- One COM port with RS-232/ 422/ 485 modes and three RS-232 COM ports

Introduction

POC-40 is an extremely compact fanless computer with dimensions measuring just 52 x 89 x 112 mm. It features Elkhart Lake Atom® processor and is designed for space-restricted applications such as factory data collection, rugged edge computing and mobile gateway.

Utilizing Intel's 10nm process technology, the new Elkhart Lake Atom® x6211E dual-core processor can deliver up to 1.8 times the performance boost over its previous generation. In comparison to POC-200, POC-40 provides 1.9 times computing performance at only half the size. It features generic I/O functions, such as two Gigabit Ethernet ports, four USB 3.1 Gen1/ 2.0 ports, four COM ports and optional isolated digital I/Os for industrial communication and control. In addition, by adopting dedicated M.2 B key and E key slots, the POC-40 can fully harness the bandwidth of 5G and WiFi 6 wireless communications to provide wide-area coverage and real-time data transmission for industrial and mobile gateway applications.

With a similar footprint as a PICO-ITX motherboard, Neousys' POC-40 is perfect for projects that require above par performance in an extremely compact package. Ideal for both edge computing and gateway applications, it is a low power consumption and lightweight fanless computer that offers wide-temperature operation for harsh environments.

Specifications

System Core		Internal Expansion Bus	
Processor	Intel® Elkhart Lake Atom® x6211E dual-core 1.3GHz/ 3.0GHz 6W processor	M.2 B key	1x M.2 3042/ 3052 B key socket with internal SIM socket for 4G/ 5G module
Graphics	Integrated Intel® UHD Graphics	M.2 E key	1x M.2 2230 E key socket for WiFi 5/ WiFi 6 module
Memory	Up to 32 GB DDR4-3200 SDRAM (one SODIMM slot)	Power Supply	
TPM	Supports fTPM 2.0	DC Input	1x 4-pin pluggable terminal block for 12-20V DC input with optional ignition power control
Panel I/O Interface		Remote Control	1x 4-pin pluggable terminal block for remote control
Ethernet	2x Gigabit Ethernet ports by Intel® I210 GbE controllers	Mechanical	
USB 3.1	2x USB 3.1 Gen1 (5 Gbps) ports	Dimension	52 mm (W) x 89 mm (D) x 112 mm (H)
USB 2.0	2x USB 2.0 ports	Weight	0.6 kg
Video Port	1x DisplayPort connector, supporting 4096 x 2160 resolution @ 60Hz	Mounting	DIN-rail mount (standard) or Wall-mount (optional)
Serial Port	1x software-programmable RS-232/ 422/ 485 port (COM1) 3x 3-wire RS-232 ports (COM2/COM3/COM4)	Environmental	
Isolated Digital I/O	Optional 4-ch isolated digital input and 4-ch isolated digital output	Operating Temperature	-25°C ~ 70°C
Storage Interface		Storage Temperature	-40°C ~ 85°C
M.2	1x M.2 2280 M key SATA interface	Humidity	10%~90% , non-condensing
		Vibration	Operating, MIL-STD-810G, Method 514.6, Category 4
		Shock	Operating, MIL-STD-810G, Method 516.6, Procedure I, Table 516.6-II
		EMC	CE/FCC Class A, according to EN 55032 & EN 55024

Appearance

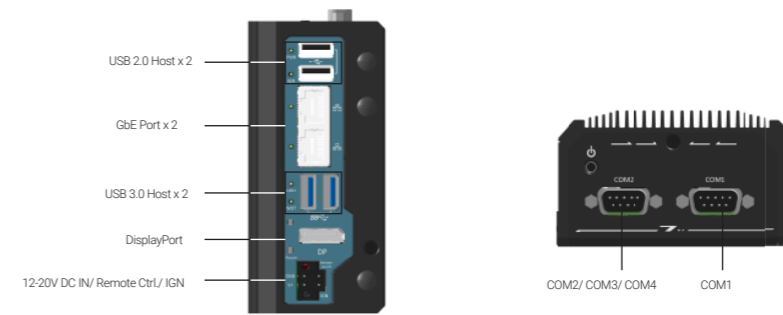

Dimensions

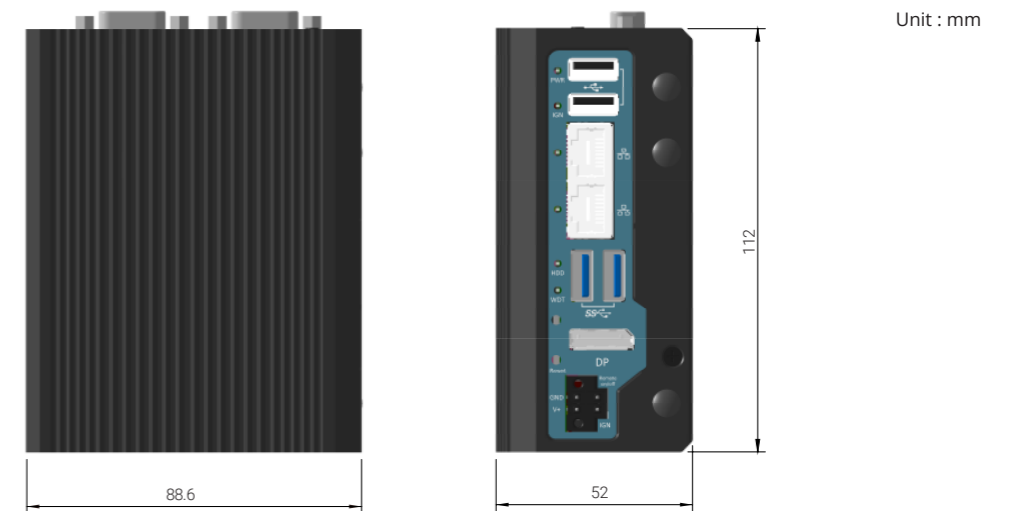

Ordering Information

Model No.	Product Description
POC-40	Intel® Elkhart Lake Atom® x6211E Extreme-compact Embedded Computer with 2x GbE and 2x USB 3.1
POC-40-DIO	Intel® Elkhart Lake Atom® x6211E Extreme-compact Embedded Controller with 2x GbE and 2x USB 3.1 and 8x isolated DIO
POC-40-IGN	Intel® Elkhart Lake Atom® x6211E Extreme-compact Embedded Controller with 2x GbE, 2x USB 3.1 and ignition power control

Optional Accessories

PA-60W-OW	60W AC/DC power adapter with 12V, 5A DC output, cord end terminals for terminal block. Operating temperature : -30 to 60 °C
Wmkit-V-POC40	Wall-mount assembly for POC-40 series, vertical type
Cbl-DB9F-3DB9M-15CM	1x DB9 (Female) to 3x DB9 (Male), length: 15CM

POC-465AWP

IP65 Waterproof Computer with Intel® Atom® x6425E, 2x 2.5GbE and Isolated COM Ports

Key Features

- IP65-rated waterproof and dustproof design
- Intel® Elkhart Lake Atom® x6425E quad-core 2.0GHz/ 3.0GHz 12W processor
- 2x 2.5GbE Ethernet ports via M12 X-coded connectors
- 1x isolated RS-232 and 1x isolated RS-422/485 via M12 A-coded connectors
- 2x USB 2.0 ports via M12 A-coded connectors
- 1x VGA port via M12 A-coded connector
- 8-35V DC input with ignition power control input via M12 A-coded connector



CE FC

Preliminary

Introduction

POC-465AWP is a new segment of Neousys fanless computers featuring an IP65 rating based on Intel® Elkhart Lake Atom. The acronym AWP stands for affordability, waterproof, and protection. In short, the POC-465AWP is designed to solve your everyday environmental challenges. With IP65 waterproof protection in a stainless steel and aluminum chassis, the air-tight system prevents internal PCBA corrosion in high salinity or humidity situations. Secondly, the hermetic enclosure can be deployed into grimy or dusty air-polluted environments such as a farm or mining site without being affected. The system also features -25°C to 70°C wide operating temperature capability and an efficient heat dissipation design to minimize thermal throttling.

Connection-wise, POC-465AWP comes with M12 connectors to ensure connection in demanding, shock, and vibration environments. The system has two 2.5G Ethernet ports, one isolated RS-232, and one isolated RS-422/485. The isolated design protects the motherboard from voltage spikes that may damage internal components. It also has a VGA, two USB2.0, an M.2 M key to support SATA SSD, and a mini-PCIe for wireless WiFi/ LTE, CAN bus, etc.

Combining IP65, M12 and great thermal design, POC-465AWP is reliable and highly tolerant to challenging conditions to fulfill versatile applications. Its ultra-compact size fits easily into confined spaces, and its waterproof capability makes it suitable for outdoor applications like wildfire detection, unmanned vehicle; or harsh environments like food / beverage manufacturing and pharmaceutical processing. The IP65 rating is an additional function that can enhance a product's value and quality, and such is the case with Neousys' POC-465AWP.

Specifications

System Core		Power Supply	
Processor	Intel® Elkhart Lake Atom® x6425E quad-core 2.0GHz/ 3.0GHz 12W processor	DC Input	8~35V DC input with ignition power control input via M12 A-coded, 5-pin connector
Graphics	Integrated Intel® HD Graphics	Mechanical	
Memory	Up to 32 GB DDR4-3200 SDRAM by one SODIMM socket	Dimension	106 mm (W) x 159.7 mm (D) x 79 mm (H)
TPM	Supports TPM 2.0 (fTPM/ dTPM)	Weight	1.45kg
I/O Interface		Mounting	Wall-mount (optional)
Ethernet	2x 2.5G Ethernet ports by Intel® I226-IT via M12 X-coded, 8-pin connector	Environmental	
Native Video Port	1x VGA connector, supporting 1920 x 1200 resolution, via M12 A-coded, 17-pin connector	Operating Temperature	-25°C ~ 70°C
Serial Port	1x isolated RS-232 port (COM1) and 1x isolated RS-422/485 ports (COM2) via M12 A-coded, 8-pin connector	Storage Temperature	-40°C ~ 85°C
USB	2x USB 2.0 ports via M12 A-coded, 8-pin connector	Humidity	10%~90% , non-condensing
Storage Interface		Vibration	Operating, MIL-STD-810G, Method 514.6, Category 4
M.2	1x M.2 2280 M key socket for SATA SSD	Shock	Operating, MIL-STD-810G, Method 516.6, Procedure I, Table 516.6-II
Internal Expansion Bus		EMC	CE/FCC Class A, according to EN 55032 & EN 55035
Mini-PCIe	1x full-size mini PCI Express socket with internal micro SIM socket		

Appearance

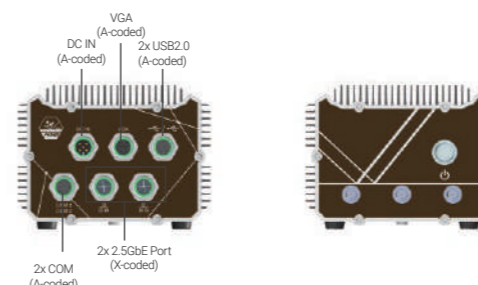

Dimensions

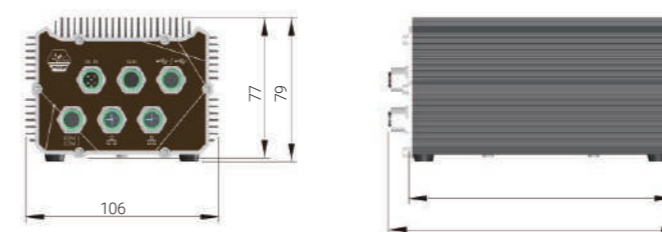

Unit : mm

Ordering Information

Model No.	Product Description
POC-465AWP	IP65 Waterproof Computer with Intel® Atom® x6425E, 2x 2.5GbE and Isolated COM Ports

Optional Accessories

PA-60W-OW	60W AC/DC power adapter with 12V, 5A DC output, cord end terminals for terminal block. Operating temperature : -30 to 60 °C
M12-Cable-Kit-POC-465AWP	2x LAN, 1x VGA, 2x USB2.0 (by Y-cable), 2x COM (by Y-cable) and DC power cables
Wmkit-POC465AWP	Wall-mount assembly for POC-465AWP

POC-300 Series

Intel® Apollo Lake Pentium® N4200 and Atom® E3950 Ultra-Compact DIN-rail Controller with GbE, PoE and USB 3.1



CE FC

Key Features

- Intel® Apollo Lake Pentium® N4200 and Atom® E3950 quad-core processor
- Fanless, rugged and wide temperature operation (-25 °C to 70 °C)
- One GbE port and two Gigabit PoE+ ports
- Two USB 3.1 and two USB 2.0 ports
- DVI + VGA dual display outputs
- Front-accessible I/O
- DIN-rail mount design
- MezIO® interface compatible

Introduction

POC-300 series features Pentium® N4200 and Atom® x7-E3950 quad-core processors, which offers up to 1.5 times of CPU performance and 3 times the GPU performance improvement compared to previous generation Atom® E3845 CPU.

POC-300 series have an ingenious mechanical design that combines DIN-rail mount chassis with front-accessible I/O in an ultra-compact enclosure. They have rich computer-like I/Os such as GbE, USB 3.1/ 2.0, COM ports and mSATA storage, in a compact footprint that measures just 5.6 x 15 x 11 cm. IEEE 802.3at PoE+ function is also available on 2 of the 3 GbE ports to power cameras for machine vision or surveillance applications. POC-300 series features Neosys' MezIO® interface for easy function expansion via versatile MezIO® modules.

With Neosys' proven fanless design heritage, the POC-300 series thrive in harsh environments. Featuring rich I/Os, advanced CPU and compact size, POC-300 series are compelling fanless controllers beneficial for various industrial applications.

Specifications

	POC-300	POC-310	POC-320	POC-330
System Core				
Processor	Intel® Atom® E3950 1.6/ 2.0 GHz quad-core processor		Intel® Pentium® N4200 1.1/ 2.5 GHz quad-core processor	
Graphics	Integrated Intel® HD Graphics 505			
Memory	Up to 8GB DDR3L-1866 (single SODIMM slot)			
Panel I/O Interface				
Ethernet	3x Gigabit Ethernet ports by Intel® I210 GbE controller			
PoE	IEEE 802.3at PoE+ on port #2 and #3, 50 W total power budget	-	IEEE 802.3at PoE+ on port #2 and #3, 50 W total power budget	-
Video Port	VGA and DVI dual display outputs via DVI-I			
USB 3.1	2x USB 3.1 Gen1 (5 Gbps) ports			
USB 2.0	2x USB 2.0 ports			
Serial Port	1x Software-programmable RS-232/ 422/ 485 ports (COM1) 3x 3-wire RS-232 ports (COM2/ 3/ 4) or 1x RS-422/ 485 port (COM2)			
Audio	1x mic-in and 1x speaker-out			
Internal I/O Interface				
Mini-PCIe	1x full-size mini PCI Express slot with USIM socket			
Expandable I/O	1x MezIO® expansion interface for Neosys MezIO® modules			
Storage Interface				
mSATA	1x half-size mSATA port			
Power Supply				
DC Input	1x 3-pin pluggable terminal block for 8 to 35V DC input			
Mechanical				
Dimension	56 mm (W) x 108 mm (D) x 153 mm (H)			
Weight	0.96 kg			
Mounting	DIN-rail mount (standard) or Wall-mount (optional)			

	POC-300	POC-310	POC-320	POC-330
Environmental				
Operating Temperature	-25°C ~ 70°C with SSD, 100% CPU loading */** -10°C ~ 50°C with HDD, 100% CPU loading */**			
Storage Temperature	-40°C ~ 85°C**			
Humidity	10%~90% , non-condensing			
Vibration	Operating, 5 Grms, 5-500 Hz, 3 Axes (w/ SSD, according to IEC60068-2-64)			
Shock	Operating, 50 Grms, Half-sine 11 ms Duration (w/ SSD, according to IEC60068-2-27)			
EMC	CE/FCC Class A, according to EN 55022, EN 55024 & EN 55032			

* The 100% CPU/GPU loading for high temperature test is applied using Passmark® BurnInTest™ v8.0. For detail testing criteria, please contact Neosys Technology
** For sub-zero operating temperature, a wide temperature HDD drive or Solid State Disk (SSD) is required.



▲ POC-300 with MezIO® - R11 and 2.5" HDD

Appearance

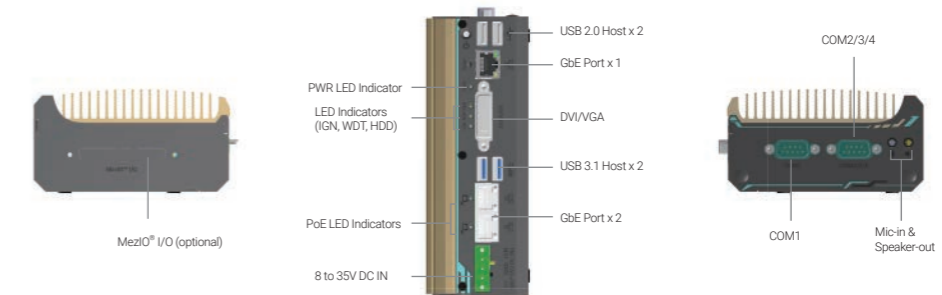

Dimensions

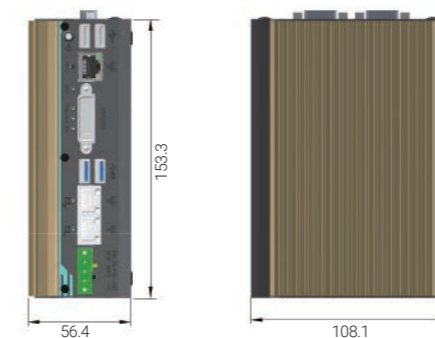

Unit : mm

Ordering Information

Model No.	Product Description
POC-300	Intel® Apollo Lake Atom® E3950 ultra-compact DIN-rail controller with 1xGbE, 2x PoE+ and 2x USB 3.1
POC-310	Intel® Apollo Lake Atom® E3950 ultra-compact DIN-rail Controller with 3xGbE and 2x USB 3.1
POC-320	Intel® Apollo Lake Pentium® N4200 ultra-compact DIN-rail controller with 1xGbE, 2x PoE+ and 2x USB 3.1
POC-330	Intel® Apollo Lake Pentium® N4200 ultra-compact DIN-rail controller with 3xGbE and 2x USB 3.1

Ordering Model Matrix

Pre-installed Controller	MezIO-R11	MezIO-R12
POC-300	POC-301	POC-302
POC-310	POC-311	POC-312
POC-320	POC-321	POC-322
POC-330	POC-331	POC-332

Optional Accessories

PA-60W-OW	60W AC/DC power adapter with 12V, 5A DC output, cord end terminals for terminal block. Operating temperature : -30 to 60 °C
Wmkit-V-POC300	Wall-mount assembly for POC-300 series, vertical type
Wmkit-H-POC300	Wall-mount assembly for POC-300 series, horizontal type
Cbl-DB9F-3DB9M-15CM	1x DB9 (Female) to 3x DB9 (Male), length: 15CM
MezIO® Modules	
MezIO®-C180	MezIO® module with 4x RS-232/ 422/ 485 ports and 4x RS-232 ports
MezIO®-C181	MezIO® module with 4x RS-232/ 422/ 485 ports and 4x RS-422/ 485 ports
MezIO®-D220	MezIO® module with 8-CH isolated digital input and 8-CH isolated digital output
MezIO®-D230	MezIO® module with 16-CH isolated digital input and 16-CH isolated digital output
MezIO®-V20	MezIO® module with ignition power control function and 1x mini-PCIe socket for in-vehicle usage
MezIO®-U4	MezIO® module with 4x USB 3.1 ports
MezIO®-R11	MezIO® module with SATA port for 2.5" HDD/ SSD
MezIO®-R12	MezIO® module with SATA port for 2.5" HDD/ SSD, 4-CH isolated DI and 4-CH isolated DO



INDUSTRIAL-GRADE INTELLIGENT SUPERCAPACITOR-BASED POWER BACKUP MODULE

Supercapacitor-based Power Backup Solution

Battery vs. Supercapacitor

For decades, battery has been the preferred form of energy storage as it has high energy density (10~100 Wh/kg). However, limited by operating temperature (typically 0°C~40°C) and cycle life (2 years or 500 charge-discharge cycles), battery is neither rugged nor durable enough for industrial applications. Supercapacitor, also called electric double-layer capacitor (EDLC), is an emerging category of capacitor offering 10~100 times more energy density than electrolytic capacitor (1~10 Wh/kg). In addition to its impressive energy density, supercapacitor also has a wide operating temperature range (-40°C~85°C) and long operating life (10 years or 500,000 charge-discharge cycles). These two traits help make it a reliable industrial power backup solution.

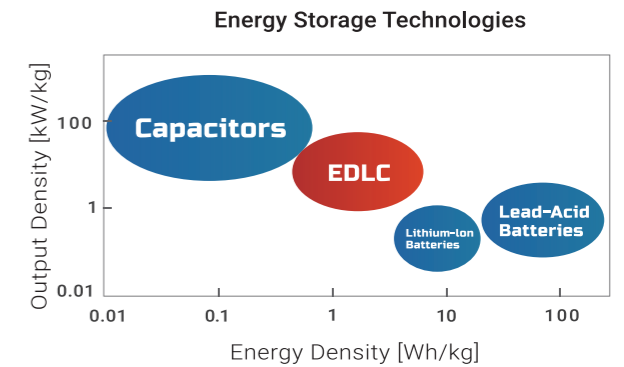

Neousys' Patented CAP Energy Management Technology

To design and create a reliable supercapacitor-based power backup system requires fundamental techniques such as charge/ discharge control, active load balance and DC/ DC regulation. But the real challenge is how to get the most out of the capacitor energy while ensuring the system shuts down safely during the blackout.

At Neousys Technology, we have patented an architecture (R.O.C. Patent No. I598820) that incorporates a microprocessor along with supercapacitor and charge/ discharge controller. The proprietary firmware embedded in the MCU not only monitors energy level continuously, it also automatically initiates soft-shutdown to prevent data loss/ corruption.

The patented architecture provides sophisticated features such as real-time energy monitoring, high/low voltage protection and auto/ manual shutdown control. Users can also extend the lifespan of ultracapacitors up to 4.8x via the parameter configuration utility.

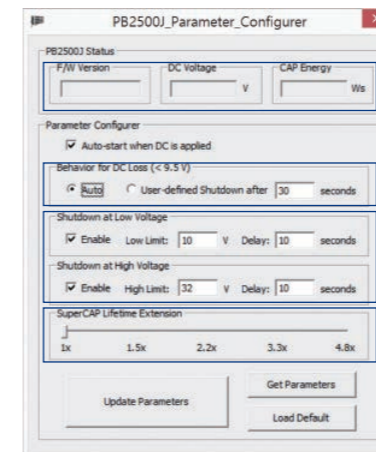
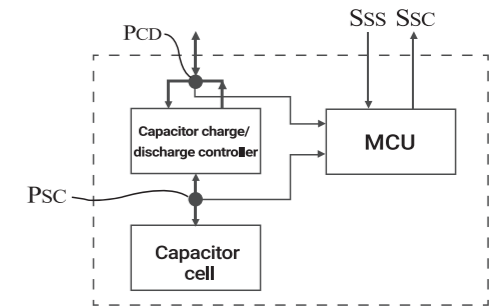

- Real-time input voltage & CAP energy monitoring
- Auto or user-configurable shutdown control
- High/ low voltage protection. Shutdown the system when input voltage exceeds or fall below thresholds
- Extend superCAP lifespan by reducing energy capacity

Supercapacitor-based Power Backup Solution vs. UPS

Combining supercapacitors and our patented architecture, Neousys introduces a revolutionary supercapacitor-based power backup solution for industrial applications. Compared to battery-based UPS, it has wider operating temperature, extended operating life, adequate backup time to secure your embedded controller against unforeseen power outages.

	PB-2500J	PB-9250J	Off-line UPS	Interactive UPS	On-line UPS
Energy storage technology	Supercapacitor	Supercapacitor	Battery	Battery	Battery
Backup time	1 ~ 3 mins	1 ~ 10 mins	> 30 mins	> 30 mins	> 30 mins
Operating temperature	-25°C ~ 65°C	-25°C ~ 65°C	0°C ~ 40°C	0°C ~ 40°C	0°C ~ 40°C
Lifespan	> 10 yrs	> 10 yrs	2 yrs @ 25°C	2 yrs @ 25°C	2 yrs @ 25°C
Regulated power output	Yes	Yes	No	No	Yes
Shutdown control	Automatic, plug and play	Automatic, plug and play	Via RS-232 and software	Via RS-232 and software	Via RS-232 and software

PB-9250J-110V

9250 w-s Standalone Supercapacitor-based UPS Module with 110V DC Input for Railway Application



Key Features

- Universal standalone power backup module compatible with all box-PCs
- Supports 43-160V wide-range DC input for railway application
- Supercapacitor-based, -40 to 70°C operation for EN 50155 OT4 class conformity
- 9250 watt-second energy capacity
- Maximum 120W output power for the connected back-end system
- Over 10 years lifespan, or 500,000 charge/ discharge cycles
- Patented CAP energy management technology*
 - Extending back-up time in the event of an unforeseen power outage
 - Monitoring energy and power consumption to extend operation time for safe system shutdown
- EN 50155 and EN 45545 certificate

*R.O.C Patent No. I598820

Introduction

Neosys' PB-9250J-110V is a newly designed SuperCAP UPS accepting 110V DC input for fast-growing railway applications. Composed with eight 370F supercapacitor, PB-9250J-110V provides 9250 watt-second stored energy to sustain back-end system from seconds to minutes during power loss. Different from traditional battery-based UPS systems, supercapacitor has a wide operating temperature range and long operating life up to 10 years. Neosys' PB-9250J-110V features -25 to 65°C operating temperature range and extremely high durability.

Thanks to Neosys' patented CAP energy management technology, PB-9250J-110V provides sophisticated features such as real-time energy/ power consumption monitoring, high/low voltage protection, and auto/ manual shutdown control. It automatically manages boot and shutdown to help your system thrive on trains with unstable power source. Additional digital output channels are incorporated for indicating system status such as charging/ discharging and power button control.

While computer systems are widely deployed in various railway applications, the rolling stock's electrical stability still remains a focal point and is crucial for system reliability. PB-9250J-110V can protect the computer or other equipment against power interruption when a train passes through a level crossing or a railroad switch. Furthermore, with its EN 50155 and EN 45545 certificate, PB-9250J-110V can be easily installed and implemented with existing computer/equipment or integrated with onboard power distribution system.



Specifications

Supercapacitor Configuration	
Composition	8x 370F, 3.0V supercapacitors
Capacity	9250 watt-second
Expected lifespan	>10 years*
Lifecycle	500,000 charging/ discharging cycles*
Power Specification	
Input Voltage	43-160 VDC
Input Connector	1x 3-pin pluggable terminal block (V+, GND)
Output Voltage	24 VDC
Output Power	Maximum 120W output
Output Connector	1x 3-pin pluggable terminal block (V+, GND)
I/O Interface	
COM Port	1x DB9 for 3-wire isolated RS-232
Isolated DIO	1x 10-pin pluggable terminal block for - ATX mode PWR_BTN# output (open-drain, pulse type) - AT mode PWR_BTN output (open-drain, level type) - DISCHARGING ALERT output (open-drain, level type) - SYS_STAT input

Mechanical	
Dimension	110(W) x 175.2mm(H) x 128.2mm(D)
Weight	2.33 kg
Mounting	DIN-rail mounting or optional wall-mounting
Environmental	
Operating Temperature	-40°C ~ 70°C EN50155 OT4 class
Storage Temperature	-40°C ~ 85°C
Vibration	Compliant with IEC61373:2010, Category 1, Class B Body mounted (part of EN50155)
Shock	Compliant with IEC61373:2010, Category 1, Class B Body mounted (part of EN50155)
EMC	EN 50155:2017, Clause 13.4.8 CE/FCC Class A, according to EN 55032 & EN 55035
EN50155	All mandatory sections of EN 50155:2017
EN45545	EN 45545-2 (Fire protection on railway vehicles)

* To achieve > 10 years lifespan under 24/7 at 70°C operation, please charge PB-9250J-SA to 6525J energy level using the 4.8x SuperCAP Lifetime Extension setting (please refer to the user manual for details). Once the rated lifetime or cycle life has been reached, the capacity of supercapacitor may decrease up to 30% and ESR may increase up to 100% from initial values.

** Backup time for uninterruptible operation may be reduced when sustaining a back-end system with high power consumption. Please consult with Neosys Technology if your computer accepts only constant-voltage input.

*** To ensure PB-9250J's power backup operation functions as intended, please contact Neosys Technology technical support if your connecting back-end system accepts only constant voltage input.

Appearance

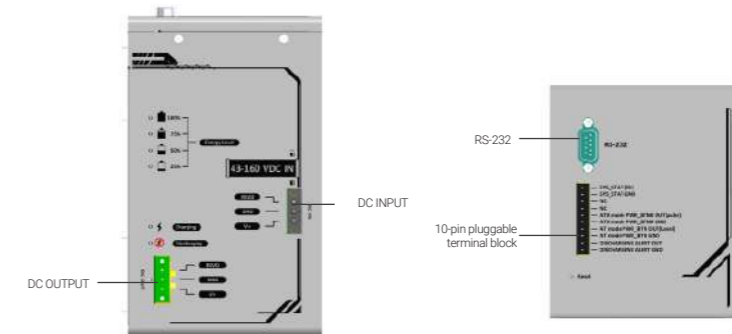

Dimensions

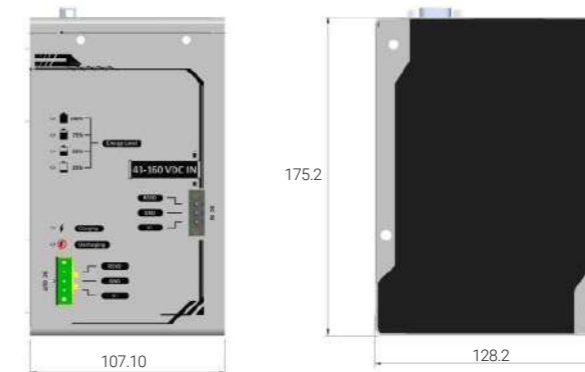

Unit : mm

Ordering Information

Model No.	Product Description
PB-9250J-110V	9250 w-s Standalone Supercapacitor-based UPS Module with 110V DC input for Railway Application

Optional Accessories

Wmkit-V-PB9250J-110V	Wall-mount assembly for PB-9250J-110V, vertical type
----------------------	--

PB-9250J-SA/ PB-4600J-SA/ PB-2580J-SA

Industrial-grade Standalone Intelligent Supercapacitor-based Uninterruptible Power Backup Module

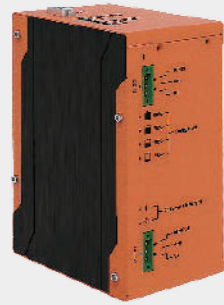

CE FC

Key Features

- Universal standalone power backup module compatible with all box-PCs
- Supercapacitor-based, -25 to 65°C wide temperature operation
- Up to 9250 watt-second energy capacity
- Maximum 180W output power for the connected back-end system
- Over 10 years lifespan, and 500,000 charging/ discharging cycles
- Patented CAP energy management technology*
- Extending back-up time in the event of an unforeseen power outage
- Monitoring energy and power consumption to extend operation time for safe system shutdown
- Versatile operating mode
 - Normal backup mode
 - Ignition control mode for standard box-PC and in-vehicle controller
- EN50155 certificate

*R.O.C Patent No. I598820

Introduction

The PB series is a standalone power backup module that can protect your box-PC against power outages. Utilizing state-of-the-art supercapacitor technology, it can operate in harsh environments from -25°C to 65°C and have extremely high durability lasting over 10 years.

PB-9250J-SA and PB-4600J-SA are composed of eight and four 370F/ 3.0V supercapacitors, respectively, while PB-2580J-SA is composed of eight 100F/ 2.7V supercapacitors. They each offer 9250, 4600 and 2580 watt-second energy to offer extra extended operation time to backup your system.

Thanks to Neosys' patented CAP energy management technology, It can reliably supply up to 180W of power to the back-end system and automatically manage boot and shutdown without installing additional drivers/ software. In addition to the UPS-like power backup mode, it also offers two advanced ignition control modes for in-vehicle usage.

PB-9250J-SA can work with either standard box-PC or in-vehicle controller to provide a stable power supply and execute user-configurable power-on/ power-off delay according to IGN signal input. Featuring various modes, automatic shutdown control and up to 180W output power, Neosys PB series can work with most off-the-shelf box-PCs. And with properties such as maintenance-free energy storage and uninterruptible power supply, the PB series can prevent the connected back-end system from data loss during a power outage in harsh industrial environments!



Specifications

	PB-9250J-SA	PB-4600J-SA	PB-2580J-SA
Supercapacitor Configuration			
Composition	8x 370F, 3.0V supercapacitors	4x 370F, 3.0V supercapacitors	8x 100F, 2.7V supercapacitors
Capacity	9250 watt-second	4600 watt-second	2580 watt-second
Expected lifespan	>10 years *		
Lifecycle	500,000 charging/ discharging cycles*		
Power Specification			
Input Voltage	12 to 35V DC input		
Input Connector	1x 3-pin pluggable terminal block (V+, GND, IGN_IN)		
Output Voltage	Charge mode: DC_IN bypass (DC_OUT = DC_IN) Discharge mode: 12 or 24V***		
Output Power	Maximum 180W output**	Maximum 100W output**	Maximum 70W output**
Output Connector	1x 3-pin pluggable terminal block (V+, GND, IGN_OUT)		
I/O Interface			
COM Port	1x DB9 for 3-wire RS-232		
Isolated DIO	1x 10-pin pluggable terminal block for - PWR_BTN# output - SYS_STAT input		

	PB-9250J-SA	PB-4600J-SA	PB-2580J-SA
Mechanical			
Dimension	82.5mm(W) x 175.2mm(H) x 128.2mm(D)		32.8mm(W) x 176.6mm(H) x 126mm(D)
Weight	1.7 kg	1.68 kg	0.93 kg
Mounting	DIN-rail mount (standard) or Wall-mount (optional)		
Environmental			
Operating Temperature	-25°C ~ 65°C -40°C ~ 85°C with reduced energy capacity		
Storage Temperature	-40°C ~ 85°C		
Vibration	Compliant with IEC61373:2010, Category 1, Class B Body mounted (part of EN50155)	Operating, MIL-STD-810G, Method 514.6, Category 4	
Shock	Compliant with IEC61373:2010, Category 1, Class B Body mounted (part of EN50155)	Operating, MIL-STD-810G, Method 516.6, Procedure I, Table 516.6-II	
EMC	Compliant with EN50155:2007, CE/FCC Class A, according to EN 55032 & EN 55035	CE/FCC Class A, according to EN 55032 & EN 55024	

* To achieve > 10 years lifespan under 24/7 at 65°C operation, please charge PB-9250J-SA to 6525J energy level using the 4.8x SuperCAP Lifetime Extension setting (please refer to the user manual for details). Once the rated lifetime or cycle life has been reached, the capacity of supercapacitor may decrease up to 30% and ESR may increase up to 100% from initial values.

** Backup time for uninterruptible operation may be reduced when sustaining a back-end system with high power consumption. Please consult with Neosys Technology if your computer accepts only constant-voltage input.

*** To ensure PB-9250J and PB-4600J's power backup operation functions as intended, please contact Neosys Technology technical support if your connecting back-end system accepts only constant voltage input.

Appearance

PB-9250J-SA/
PB-4600J-SA

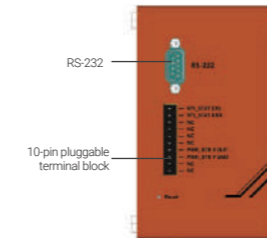
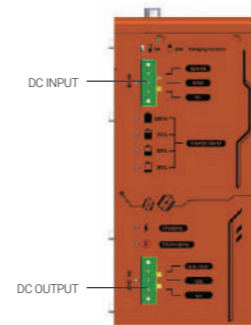

PB-2580J-SA

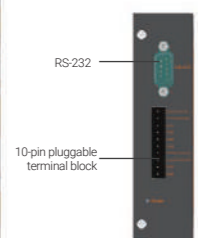
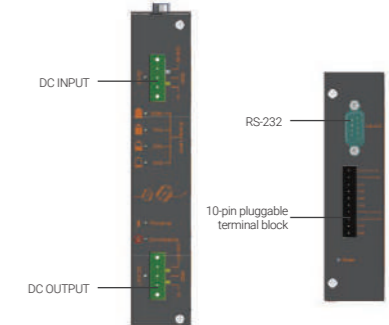

Dimensions

PB-9250J-SA/
PB-4600J-SA

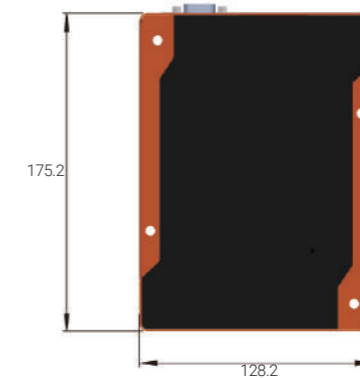
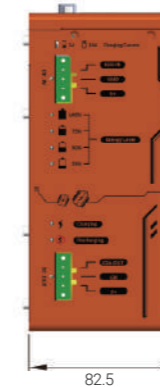

PB-2580J-SA

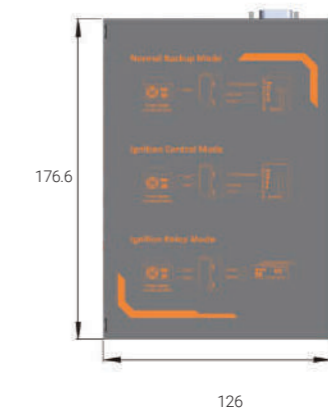

Unit : mm

Ordering Information

Model No.	Product Description
PB-9250J-SA	Standalone intelligent supercapacitor-base power backup module with 9250 W-s energy capacity
PB-4600J-SA	Standalone intelligent supercapacitor-base power backup module with 4600 W-s energy capacity
PB-2580J-SA	Standalone intelligent supercapacitor-base power backup module with 2580 W-s energy capacity

Optional Accessories

Wmkit-V-PB9250J	Wall-mount assembly for PB Series, vertical type
-----------------	--

PB-2500J Series

Industrial-grade Intelligent Supercapacitor-based Uninterruptible Power Backup Module



CE FC

Key Features

- Supercapacitor-based, -25 to 65°C wide temperature operation
- 2500 watt-second energy capacity
- Up to 10 years lifespan and 500,000 charging/ discharging cycles
- Patented CAP energy management technology*
 - Maximizes back-up time in an event of unforeseen power outage
 - Monitors energy consumed and estimates the time required for system shutdown
- User-configurable operating parameters
 - Auto/ manual shutdown control
 - High/ low voltage protection
 - UltraCAP energy/ lifespan configuration

*R.O.C Patent No. I598820



Introduction

Neousys' PB-2500J series is an innovative power backup solution for demanding industrial applications. Utilizing supercapacitor technology, it features -25°C to 65°C operating temperature range and extremely high durability. Compared to traditional battery-based UPS systems, PB-2500J series can sustain superb reliability in extreme temperature environments and eliminates the drawback of battery performance degradation over time.

PB-2500J series is composed of eight 100F supercapacitors to provide 2500 watt-second stored energy to sustain your computer during power outage and depending on your system's power consumption, it could be from seconds to minutes. But what makes PB-2500J novel is its patented CAP energy management technology, an on-board processor that constantly monitors power consumption and evolves with the system. During a power outage, it maximizes the system operation time by estimating the perfect time to initiate system shutdown to prevent data loss.

PB-2500J series is available in two form-factors; PB-2500J-PCIe is a plug-and-play PCIe card specifically designed for Neousys Nuvo-6000 (except Nuvo-6108GC/IGN) while PB-2500J-CSM is designed for Nuvo-5000E/P and Nuvo-7000E/P series.

When it comes to industrial embedded controllers, stability and data loss prevention during power outages are just as important. Neousys' PB-2500J series aims to redefine reliability and take it to another level. With PB-2500J series, unexpected power loss and unstable power lines are a thing in the past!

Specifications

	PB-2500J-PCIe	PB-2500J-CSM
Supercapacitor configuration	8x 100F, 3.0V ultracapacitors	
Capacity	2500 watt-second	
Expected lifespan	>10 years @ 25°C with 2500 w-s capacity* 76,000 hours @ 35°C with 2500 w-s capacity* 34,000 hours @ 45°C with 2500 w-s capacity* 15,000 hours @ 55°C with 2500 w-s capacity* 7,200 hours @ 65°C with 2500 w-s capacity* Expected lifespan is 2.2x when configured as 2100 watt-second energy capacity, or 4.8x when configured as 1750 watt-second energy capacity.	
Lifecycle	500,000 charging/ discharging cycles*	
Communication interface	3-wire RS-232	
Dimension	Half-length PCIe card 167 mm (W) x 111 mm (H)	-
Operating Temperature	-25°C ~ 65°C	
Storage Temperature	-40 °C~ 70°C	
EMC	CE/FCC Class A, according to EN 55022 & EN 55024	

*Once the rated lifespan or cycle life has been reached, the capacity of ultracapacitor may decrease up to 30% and ESR may increase up to 100% from initial values.

Ordering Information

Model No.	Product Description
PB-2500J-PCIe	Intelligent supercapacitor-based power backup PCIe card with 2500 w-s energy capacity
PB-2500J-CSM5	Intelligent supercapacitor-based power backup Cassette module with 2500 w-s energy capacity, for Nuvo-5000 series
PB-2500J-CSM7	Intelligent supercapacitor-based power backup Cassette module with 2500 w-s energy capacity, for Nuvo-7000 series

*Note: NOT compatible with Nuvo-6108GC, Nuvo-6108GC-IGN and Nuvo-8208GC



IGT-33V/ IGT-34C

TI Sitara™ AM3352 ARM-based Industrial IoT Gateway with Analog Inputs and Pre-installed Debian



CE FCC

Key Features

- Industrial grade ARM-based system with pre-installed Debian
- Built-in isolated analog input and DI/O channels
- Dual LAN and COM ports for expend
- 12 to 25V wide-range DC input and 802.3at PoE+ PD
- -25°C to 70°C wide temperature operation

Introduction

Neousys IGT-30 series, equipped with AM3352 from Texas Instrument's Sitara AM335x family, is an ARM-based Box PC aimed at Industrial Internet of Things (IIoT) Gateway and Industry 4.0 applications. As required by any industrial applications, IGT-30 series is shipped as a ready system pre-installed with Debian and in compliance with common industrial certifications such as CE/FCC, shock and vibration. It has a power input range of 12 to 25 VDC and a wide operating temperature from -25°C to 70°C to ensure IGT-30 series continues to function under harsh industrial conditions.

IGT-33V/ 34C have rich I/Os for users to connect to a variety of industrial sensors and devices. It features one USB 2.0 port, dual 10/100M LAN ports and two COM ports (one RS-485, one configurable RS-232/422/485). In addition, IGT-33V/ 34C also integrate analog and digital ports, such as eight 0-10V voltage inputs for IGT-33V and four 4-20mA current inputs for IGT-34C. There are also two built-in isolated digital inputs for button/switch and six digital outputs for actuators or modules controll. User can easily build their own private serial automation or IIoT system.

Communication wise, IGT-30 series has a mini PCIe slot and a USIM holder allowing it to transmit acquired data and system status via 3G, 4G or WiFi (mini PCIe WiFi module). There is an opening on top of IGT-30 series for users to mount the SMA connector of the wireless module. In terms of storage, IGT-30 series has dual microSDHC slots, one internal and one external. This design allows users to separate system/ user data and can expedite in OS deployment for mass production. Inherited from IGT-20, IGT-30 series provides six LED indicators and two function buttons that can be programmed by users. The function buttons can act as controls for IGT-30 series and exclude the need for external input devices, such as keyboard/ mouse.

Specifications

	IGT-33V	IGT-34C
System Core		
Processor	TI Sitara AM3352 1GHz processor	
Memory	1GB DDR3L SDRAM	
Front-panel I/O Interface		
Ethernet	2x 10/100 LAN, 1 with PoE PD	
USB 2.0	1x USB 2.0	
SD Card	1x external T-flash socket support miscro SDHC	
Function Buttons	2x user programmable buttons	
User LEDs	6x user programmable LEDs	
Isolated DIO	2x digital input 6x digital output	
Analog Input	8x 16 bit 0-10V/ ±5V/ ±10V Voltage Input	4x 16 bit 4-20mA/ 0-20mA Current Input
Top I/O Interface		
DC IN	1x DC Input connector	
Power Button	1x power button	
Reset Button	1x reset button	
Console	1x RS-232 as Console Port	
Serial Port	1x RS-232/422/485 1x RS-485	
Antenna Hole	2x antenna hole for WiFi and 3G/LTE	
Internal I/O Interface		
SD Card	1x internal T-flash socket support micro SDHC	
mPCIe	1x full size mPCIe	
SIM Card	1x internal SIM socket	
Software		
Operating System	Debian 9 pre-installed	
Power Supply		
DC Input Range	12 to 25V DC input	
PoE+ PD	IEEE 802.3at PoE+ PD	
Mechanical		
Dimension	43mm (W) x 77mm (D) x 104mm (H)	
Weight	0.5 Kg	
Mounting	DIN-rail mount	
Environmental		
Operating Temperature	-25°C~70°C *	
Storage Temperature	-40°C~85°C	
Humidity	5Grms	
Shock	50Grms	
EMC	CE/FCC Class A, according to EN55032 & EN55024	

* For sub-zero operating temperature, a wide temperature microSD module is required.

Appearance

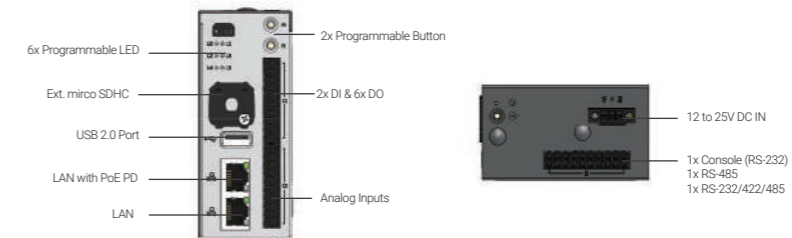

Dimensions

Unit : mm

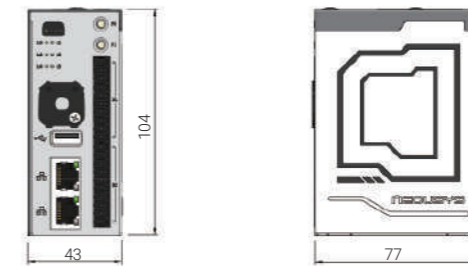

Ordering Information

Model No.	Product Description
IGT-33V	Industrial grade ARM-based IoT gateway with 0-10V analog inputs, dual LAN and PoE PD enable
IGT-34C	Industrial grade ARM-based IoT gateway with 4-20mA analog inputs, dual LAN and PoE PD enable

Optional Accessories

NSIO-LTE-7455	Cat. 6 LTE embedded socket modem
---------------	----------------------------------

IGT-30D/ IGT-31D

TI Sitara™ AM3352 ARM-based Industrial IoT Gateway with Dual LAN and Pre-installed Debian

Key Features



CE FCC

- Industrial grade ARM-based system with pre-installed Debian
- Microsoft Azure and AWS Greengrass Certified for IoT
- Field-ready isolated DI/O and RS-232/422/485
- 12 to 25V wide-range DC input and 802.3at PoE+ PD
- -25°C to 70°C wide temperature operation

Introduction

Neousys IGT-30 series, equipped with AM3352 from Texas Instrument's Sitara AM335x family, is an ARM-based Box PC aimed at Industrial Internet of Things (IIoT) Gateway and Industry 4.0 applications. As required by any industrial applications, IGT-30 series is shipped as a ready system pre-installed with Debian and in compliance with common industrial certifications such as CE/FCC, shock and vibration. It has a power input range of 12 to 25 VDC and a wide operating temperature from -25°C to 70°C to ensure IGT-30 continues to function under harsh industrial conditions.

IGT-30 series supports PoE Powered Device (PD) mode meaning it can be powered by a LAN cable from a PoE Power Sourcing Equipment (PSE), and at the same time transfer data via this cable as well. IGT-30 series has I/Os that are applicable to a range of industrial grade sensors. It features one USB 2.0 port, two 10/100M LAN ports, one configurable COM port (RS-232/ 422/ 485) and an optional CAN bus port (IGT-31D only). In addition to the ports mentioned, there are also 8 built-in isolated digital input channels that accept discrete signals from various sensors or buttons/ switches. There are also 2 built-in isolated digital output channels to control actuators and indicators.

Communication wise, IGT-30 series has a mini PCIe slot and a USIM holder allowing it to transmit acquired data and system status via 3G, 4G or WiFi (mini PCIe WiFi module). There are two openings on top of IGT-30 series for users to mount the SMA connector of the wireless module. In terms of storage, IGT-30 series has dual microSDHC slots, one internal and one external. This design allows users to separate system/ user data and can expedite in OS deployment for mass production. Inherited from IGT-20, IGT-30 series provides six LED indicators and two function buttons that can be programmed by users. The function buttons can act as controls for IGT-30 series and exclude the need for external input devices, such as keyboard/ mouse.

Specifications

System Core		Internal I/O Interface	
Processor	TI Sitara AM3352 1GHz processor	mPCIe	1x full size mPCIe
Memory	1GB DDR3L SDRAM	SD Card	1x internal T-flash socket support microSDHC
Front-panel I/O Interface		SIM Card	1x internal SIM socket
Ethernet	2x 10/100 LAN	Software	
SD Card	1x external T-flash socket support microSDHC	Operating System	Debian 9 pre-installed
USB	1x USB 2.0	Power Supply	
Isolated DIO	8-CH isolated DI and 2-CH isolated DO	DC input range	12 to 25V DC input
Serial Port	1x software configurable RS-232/422/485	PoE+ PD	IEEE 802.3at PoE+ PD
User LEDs	6x user programmable LEDs	Mechanical	
Function Buttons	2x user programmable buttons	Dimension	43mm(W) x 77mm(D) x 104mm(H)
CAN	1x isolated CAN bus 2.0 A/B (IGT-31D only)	Weight	0.5 Kg
Top I/O Interface		Mounting	DIN-rail mount
DC IN	1x DC INput connector	Environmental	
Power Button	1x power button	Operating Temperature	-25°C ~ 70°C *
Reset Button	1x reset button	Storage temperature	-40°C ~ 80°C *
Console	1x RS-232 as Console Port	Humidity	10%~90%, non-condensing
Antenna Hole	2x antenna hole for WiFi and 3G/ LTE	Vibration	5Grms
		Shock	50Grms
		EMC	CE/FCC Class A, according to EN55032 & EN55024

* For sub-zero operating temperature, a wide temperature microSD module is required.

Appearance

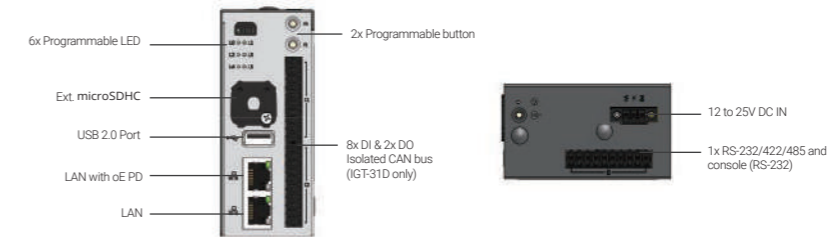

Dimensions

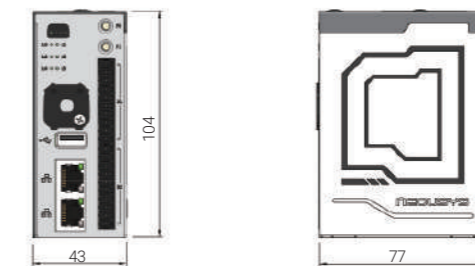

Ordering Information

Model No.	Product Description
IGT-30D	Industrial grade ARM-based IoT gateway with dual LAN and PoE PD enabled
IGT-31D	Industrial grade ARM-based IoT gateway with dual LAN, CAN bus and PoE PD enabled

Optional Accessories

NSIO-LTE-7455	Cat. 6 LTE embedded socket modem
---------------	----------------------------------

IGT-20/ IGT-21/ IGT-22

Industrial Grade ARM-based Smart Wireless IoT Gateway with ARM Cortex A8, Dual T-Flash (microSD), and Pre-installed Debian



CE FC

Key Features

- Industrial grade ARM-based system with pre-installed Debian
- Microsoft Azure and AWS Greengrass Certified for IoT
- Field-ready isolated DI/O and serial ports
- 8 to 25V wide-range DC input
- -25°C to 70°C wide temperature operation

Introduction

Neousys IGT-20 series, equipped with AM3352 from Texas Instrument's Sitara AM335x family, is an ARM-based Box PC aimed at Industrial Internet of Things (IIoT) Gateway and Industry 4.0 applications. As required by any industrial applications, IGT-20 series is shipped as a ready system preinstalled with Debian and is in compliance with common industrial certifications such as CE/FCC, shock and vibration. It has a power input range of 8 to 25 VDC and a wide operating temperature from -25°C to 70°C to ensure IGT-20 series continues to function under harsh industrial conditions.

IGT-20 series has I/Os that are applicable to a range of industrial grade sensors. It features one USB 2.0, one 10/100M LAN, COM ports and an optional CAN bus port (IGT-21 only). In addition to the ports mentioned, there are built-in isolated digital input channels that accept discrete signals from various sensors, buttons or switches. There are also built-in isolated digital output channels to control actuators and indicators.

Communication wise, IGT-20 series has a mini PCIe slot and an external USIM holder allowing it to transmit acquired data and system status via 3G, 4G or WiFi (mini PCIe WiFi module). There is an opening on top of IGT-20 series for users to mount the SMA connector of the wireless module. In terms of storage, IGT-20 series has dual microSDHC slots, one internal and one external. This design allows users to separate system/ user data and can expedite in OS deployment for mass production. IGT-20 series also provides six LED indicators and two function buttons that can be programmed by users. The function buttons can act as controls for IGT-20 series and exclude the need for external input devices, such as keyboard/ mouse.

Specifications

	IGT-20	IGT-21	IGT-22
System Core			
Processor	TI Sitara AM3352 1GHz processor		
Memory	1GB DDR3L SDRAM		
RTC	-	-	Yes
Front-panel I/O Interface			
Ethernet	1x 10/100M Ethernet		
SD Card	1x external T-flash socket support SDHC		
SIM Card	1x external SIM socket		
USB 2.0	1x USB 2.0		
Isolated DI/O	4-CH isolated DI and 4-CH isolated DO	8-CH isolated DI and 8-CH isolated DO	
Console	1x 3-wire RS-232 as Console Port		
User LEDs	6x user programmable LEDs		
User Buttons	2x user programmable buttons		
CAN	-	1x CAN bus 2.0 A/B	-
Top I/O Interface			
DC IN	1x DC Input connector		
Power Button	1x power button		
Reset Button	1x reset button		
Serial Port	2x software configurable RS-232/ 422/ 485	1xRS-232 and 1x RS-485	
Antenna Opening	1x antenna opening for WiFi and 3G/LTE		
Internal I/O Interface			
mPCIe	1x full size mPCIe with USB 2.0 only		
SD Card	1x internal T-flash socket support SDHC		
Software			
Operating System	Pre-installed Debian 8	Pre-installed Debian 9	
Power Supply			
DC input range	8 to 25V DC input		
Mechanical			
Dimension	41mm(W) x 77mm(D) x 104mm(H)		
Weight	0.4 Kg		
Mounting	DIN-rail mount		
Environmental			
Operating Temperature	-25°C ~ 70°C *		
Vibration	5Grms		
Shock	50Grms		
EMC	CE/FCC Class A, according to EN 55032		

* For sub-zero operating temperature, a wide temperature microSD module is required.

Appearance

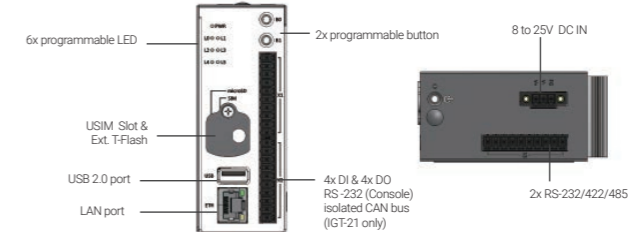

Dimensions

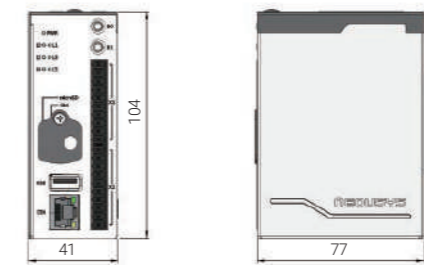

Unit : mm

Ordering Information

Model No.	Product Description
IGT-20	Industrial grade ARM-based IoT gateway with 4DI and 4DO
IGT-21	Industrial grade ARM-based IoT gateway with 4DI, 4DO and CAN bus
IGT-22	Industrial grade ARM-based IoT gateway with 8DI and 8DO

Optional Accessories

NSIO-LTE-7455	Cat. 6 LTE embedded socket modem
---------------	----------------------------------



Machine Vision



Nuvis-7306RT Series

Intel® 9th/ 8th-Gen Core™ i vision controller with vision-specific I/O, real-time controller and GPU-computing



CE FC

Key Features

- Intel® 9th/ 8th-Gen Core™ i7/i5 LGA1151 socket-type CPU
- Integrated vision-specific I/O
 - 4-CH CC/CV lighting controller
 - 4-CH camera trigger outputs
 - 1-CH quadrature encoder input
 - 8-CH isolated DI and 8-CH isolated DO
- Patented MCU-based, real-time I/O control by DTIO V2 and NuMCU
- Built-in camera interfaces
 - 4-CH IEEE 802.3at Gigabit PoE+ ports with screw-lock
 - 8-CH USB 3.1 ports with screw-lock
- Two x16 PCIe slots for NVIDIA 120W GPU and/or image capture card

Preliminary

*R.O.C Patent No. 1526834/ M534371 / M456527

Introduction

Nuvis-7306RT series is an all-in-one powerful vision controller incorporating every function needed for machine vision applications. Powered by Intel® 9th/ 8th-Gen Core™ i7/i5, Nuvis-7306RT brings tremendous computing power for image processing.

Nuvis-7306RT integrates constant-current lighting controller, isolated 12V camera trigger output, encoder input for position information and DIO to connect sensors/ actuators. Thanks to Neosys' patented MCU-based architecture and DTIO/ NuMCU firmware, Nuvis-7306RT is able to overcome latencies between sensor input and trigger output. It offers microsecond-scale real-time I/O control that guarantees in-time or in-position image capture.

For deep learning vision applications, Nuvis-7306RT can accommodate an NVIDIA® 120W TDP GPU to leverage state-of-the-art object detection/ classification neural network models. Built-in vision-oriented I/O along with remarkable performance makes Nuvis-7306RT the most exceptional vision controller that fits right into the modern vision industry.

Specifications

System Core		Storage Interface	
Processor	Supporting Intel® 9th/ 8th-Gen Coffee Lake CPU (LGA1151 socket, 65W/ 35W TDP) - Intel® Core™ i7-9700E/ i7-9700TE/ i7-8700/ i7-8700T - Intel® Core™ i5-9500E/ i5-9500TE/ i5-8500/ i5-8500T	SATA HDD/ SSD	2x internal SATA port for 2.5" HDD/ SSD installation, supporting RAID 0/ 1
Chipset	Intel® Q370 platform controller hub	M.2	1x M.2 2280 M key socket (PCIe Gen3 x4) for NVMe SSD or Intel® Optane™ memory installation
Graphics	Integrated Intel® UHD graphics 630	mSATA	1x full-size mSATA port (mux with mini-PCIe)
Memory	Up to 64 GB DDR4 2666/ 2400 SDRAM (two SODIMM slots)	Expansion Bus	
AMT	Supports AMT 12.0	PCI Express	2x PCIe x16 slot @ Gen3, 8-lane PCIe signals in Cassette, supporting - 120W NVIDIA® GPU card - COTS CameraLink and CoaXPress camera interface card
TPM	Supports TPM 2.0	Mini PCI-E	1x full-size mini PCI Express socket with internal SIM socket (mux with mSATA)
Vision-Specific I/O Interface		M.2	1x M.2 2242 B key socket with dual front-accessible SIM sockets, supporting dual SIM mode with selected M.2 LTE module
LED Lighting Controller	4-CH LED lighting controller output, supporting - Constant current mode (up to 2A per channel, 100 kHz dimming control) - Constant voltage mode (24 VDC, 100 kHz dimming control)	Power Supply	
Camera Trigger	4-CH camera trigger output (Isolated 12 VDC output)	DC Input	1x 3-pin pluggable terminal block for 8 to 35V DC input
Encoder Input	1-CH quadrature encoder input (A/B/Z)	Remote Ctrl. & Status Output	1x 3-pin pluggable terminal block for remote control and PWR LED output
Isolated Digital Output	4-CH isolated high-speed digital output (<2 us transient time, for strobe/PWM) 4-CH isolated high-current digital output (up to 500 mA rated current for actuator)	Mechanical	
Isolated Digital Input	8-CH isolated high-speed digital input (<2 us transient time)	Dimension	240 mm (W) x 225 mm (D) x 111 mm (H)
Real-time I/O Control	Patented MCU-based real-time I/O control with DTIO V2 or NuMCU firmware	Weight	3.7 kg
I/O Interface		Mounting	Wall-mount
Ethernet	6x Gigabit Ethernet ports by I219 and I210	Environmental	
PoE+	4x IEEE 802.3at (25.5W) Gigabit PoE+ ports by Intel® I210 with RJ45 connector	Operating Temperature	with 35W CPU and NVIDIA® 120W GPU -25°C ~ 60°C ** with 65W CPU and NVIDIA® 120W GPU -25°C ~ 60°C */ ** (configured as 35W TDP mode) -25°C ~ 50°C */ ** (configured as 65W TDP mode)
USB 3.1	4x USB 3.1 Gen2 (10 Gbps) ports 4x USB 3.1 Gen1 (5 Gbps) ports	Storage Temperature	-40°C ~ 85°C**
USB 2.0	1x USB 2.0 port (internal use)	Humidity	10%~90% , non-condensing
Video Port	1x VGA , supporting 1920 x 1200 resolution 1x DVI-D, supporting 1920 x 1200 resolution 1x DisplayPort, supporting 4096 x 2304 resolution	Vibration	Operating, MIL-STD-810G, Method 514.6, Category 4
Serial Port	2x software-programmable RS-232/422/485 ports (COM1/ COM2) 2x RS-232 ports (COM3/ COM4)	Shock	Operating, MIL-STD-810G, Method 516.6, Procedure I, Table 516.6-II
Audio	1x 3.5 mm jack for mic-in and speaker-out	EMC	CE/FCC Class A, according to EN 55032 & EN 55024

* For i7-9700E and i7-8700 running at 65W mode, the highest operating temperature shall be limited to 50°C and thermal throttling may occur when sustained full-loading applied. Users can configure CPU power in BIOS to obtain higher operating temperature.

** For sub-zero operating temperature, a wide temperature HDD or Solid State Disk (SSD) is required.

Appearance

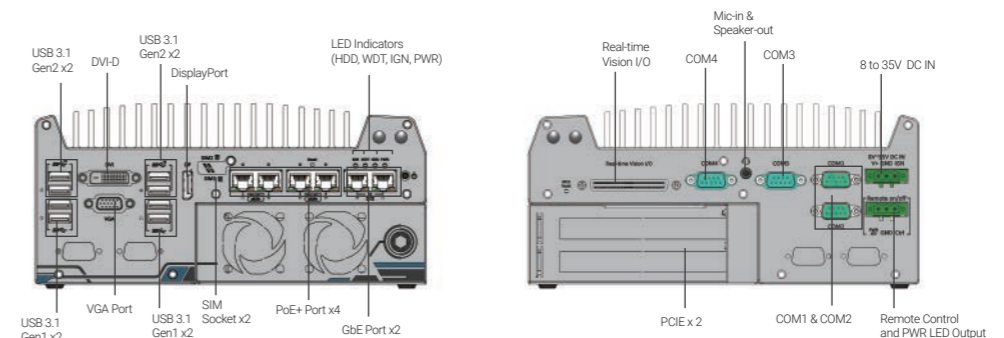

Dimensions

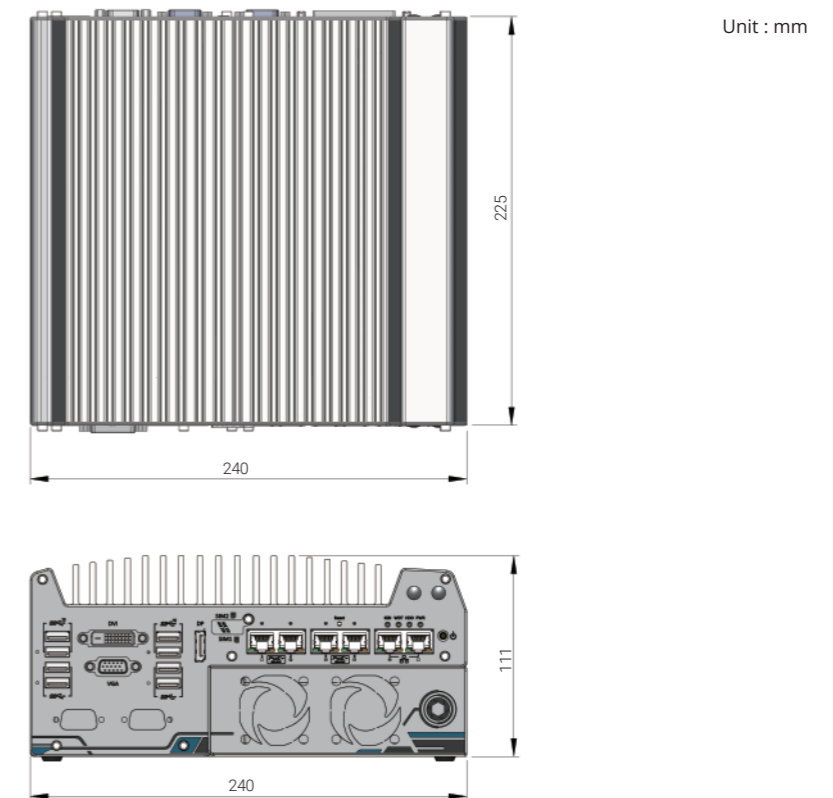

Ordering Information

Model No.	Product Description
Nuvis-7306RT-DTIO	Intel® 9th/ 8th-Gen Core™ i machine vision controller with vision-specific I/O, real-time controller by patented DTIO V2 and GPU-computing
Nuvis-7306RT-NuMCU	Intel® 9th/ 8th-Gen Core™ i machine vision controller with vision-specific I/O, real-time controller by patented NuMCU and GPU-computing

Optional Accessories

PA-280W-ET2	280W AC/DC power adapter 24V/11.67A; 16AWG/100cm; cord end terminals for terminal block, operating temperature : -30°C to 60°C.
PA-480W-DIN	480W AC/ DC power adapter DIN-rail mount, 24V 20A, 90-264VAC/ 127-370VDC, terminal block, -20°C to 70°C

Nuvis-5306RT Series

Intel® 6th-Gen Core™ i7/ i5 Vision Controller with Vision-Specific I/O, Real-time Control and GPU Computing

Key Features

- Intel® 6th-Gen Core™ i7/ i5 65W/ 35W CPU, up to 32 GB DDR4
- Integrated vision-specific I/O
 - 4-CH CC/ CV lighting controller
 - 4-CH camera trigger outputs
 - 1-CH quadrature encoder input
 - 8-CH isolated DI and 8-CH isolated DO
- Patented MCU-based, real-time I/O control by DTIO V2* and NuMCU
- Built-in camera interfaces
 - 4-CH IEEE 802.3at Gigabit PoE+ ports
 - 4-CH USB 3.1 ports
- Supports NVIDIA® GPU with up to 75W TDP GPU-accelerated machine vision
- Patented graphics card ventilation*

*R.O.C Patent No. I526834/ M534371 / M456527



CE FC

Introduction

As one of the most powerful vision controllers ever created, Nuvis-5306RT integrates every single function you need for machine vision applications in a compact footprint, including exceptional computing power, built-in camera interfaces and real-time vision-specific I/O control.

To ensure high quality images, a machine vision (MV) system requires accurate interaction between light, camera, actuator and sensor devices. Nuvis-5306RT integrates LED controller, camera trigger, encoder input, PWM output and digital I/O to connect and control all vision devices. All vision-specific I/Os are managed by Neousys' patented MCU-based architecture and DTIO V2/ NuMCU firmware to guarantee microsecond-scale real-time I/O control.

Computing power is another crucial requirement for a vision system. In addition to the remarkable performance brought by Intel® 6th-Gen Core™ i7/ i5 CPU, Nuvis-5306RT can also accommodate a 75W NVIDIA® GPU to leverage CPU-accelerated vision library or deep-learning vision software. Combining built-in PoE+ and USB 3.1 interfaces and the expandability for CameraLink and CoaXPRESS, Nuvis-5306RT is the ideal platform for demanding MV applications.

Specifications

System Core		Storage Interface	
Processor	Supports Intel® 6th-Gen Core™ LGA1151 CPU - Intel® Core™ i7-6700 (8M Cache, 3.4/ 4.0 GHz, 65W TDP) - Intel® Core™ i5-6500 (6M Cache, 3.2/ 3.6 GHz, 65W TDP) - Intel® Core™ i7-6700TE (8M Cache, 2.4/ 3.4 GHz, 35W TDP) - Intel® Core™ i5-6500TE (6M Cache, 2.3/ 3.3 GHz, 35W TDP)	SATA HDD	2x internal SATA port for 2.5" HDD/ SSD installation, supporting RAID 0/1
Chipset	Intel® Q170 platform controller hub	mSATA	1x full-size mSATA port (mux with mini-PCIe)
Graphics	Integrated Intel® HD graphics 530	Expansion Bus	
Memory	Up to 32 GB DDR4-2133 SDRAM by two SODIMM sockets	PCI/PCI Express	1x PCIe x16 slot @ Gen3, 8-lanes PCIe signals in Cassette, supporting - 75W NVIDIA® GPU card - COTS CameraLink and CoaXPRESS camera interface card
AMT	Supports AMT 11.0	Mini PCI-E	1x internal mini PCI Express socket with front-accessible SIM socket 1x internal mini PCI Express socket with internal SIM socket (mux with mSATA)
TPM	Supports TPM 2.0	Power Supply	
Vision-Specific I/O Interface		DC Input	1x 3-pin pluggable terminal block for 8 to 35V DC input
LED Lighting Controller	4-CH LED lighting controller output, supporting - Constant current mode (up to 2A per channel, 100 kHz dimming control) - Constant voltage mode (24V DC, 100 kHz dimming control)	Remote Ctrl. & Status Output	1x 10-pin (2x5) wafer connector for remote on/off control and status LED output
Camera Trigger	4-CH camera trigger output (12V DC output)	Mechanical	
Encoder Input	1-CH quadrature encoder input (A/ B/ Z)	Dimension	240 mm (W) x 225 mm (D) x 111 mm (H)
Isolated Digital Output	4-CH isolated high-speed DO (<2 us transient time, for strobe/PWM) 4-CH isolated high-current DO (up to 500 mA rated current)	Weight	4.5 kg
Isolated Digital Input	8-CH isolated high-speed digital input (<2 us transient time)	Mounting	Wall-mount
Real-time I/O Control	Patented MCU-based real-time I/O control with DTIO V2 or NuMCU firmware	Environmental	
General I/O Interface		Operating Temperature	with i7-6700TE, i5-6500TE (35W TDP) -25°C ~ 60°C ** with i7-6700, i5-6500 (65W TDP) -25°C ~ 60°C **/** (configured as 35W CPU mode) -25°C ~ 50°C **/** (configured as 65W CPU mode)
Ethernet port	6x Gigabit Ethernet ports by Intel® 1x I219 and 5x I210	Storage Temperature	-40°C ~ 85°C**
PoE+	IEEE 802.3at PoE+ PSE on GigE Port 3 ~ Port 6, 80 W total power budget	Humidity	10%~90%, non-condensing
USB 3.1	4x USB 3.1 ports via native xHCI controller, 1000 MB/s total bandwidth	Vibration	Operating, 5 Grms, 5-500 Hz, 3 Axes (w/ SSD, according to IEC60068-2-64)
USB 2.0	4x USB 2.0 ports	Shock	Operating, 50 Grms, Half-sine 11 ms duration (w/ SSD, according to IEC60068-2-27)
Video Port	1x stacked VGA + DVI-D 2x DisplayPorts, supporting 4K2K resolution	EMC	CE/ FCC Class A, according to EN 55022, EN55032 & EN 55024
Serial Port	2x software-programmable RS-232/422/485 port (COM1 & COM3) 1x RS-232 port (COM2)	* For i7-6700 running at 65W mode, the highest operating temperature shall be limited to 50°C and thermal throttling may occur when sustained full-loading applied. Users can configure CPU power in BIOS to obtain higher operating temperature. ** For sub-zero operating temperature, a wide temperature HDD drive or Solid State Disk (SSD) is required.	
Audio	1x mic-in and 1x speaker-out		

* For i7-6700 running at 65W mode, the highest operating temperature shall be limited to 50°C and thermal throttling may occur when sustained full-loading applied. Users can configure CPU power in BIOS to obtain higher operating temperature.
** For sub-zero operating temperature, a wide temperature HDD drive or Solid State Disk (SSD) is required.

Appearance

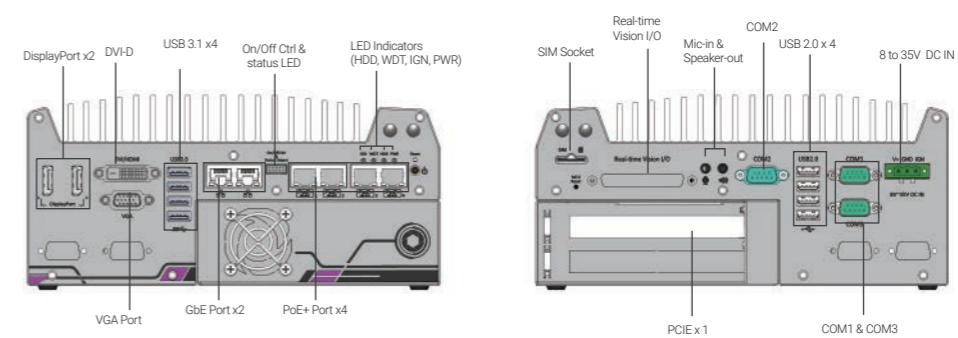

Dimensions

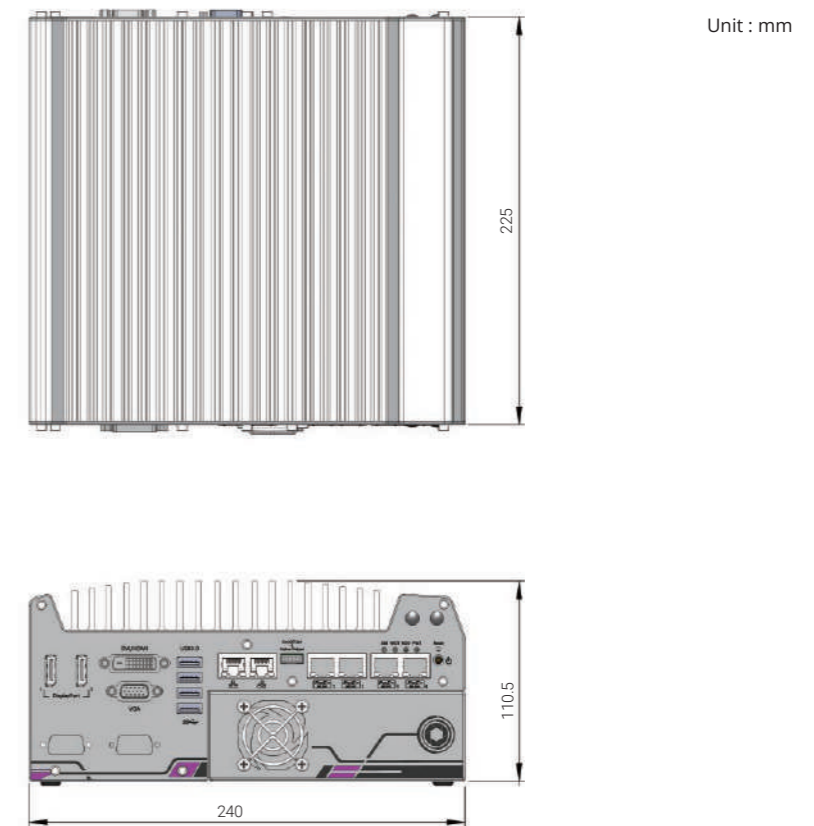

Ordering Information

Model No.	Product Description
Nuvis-5306RT-DTIO	Intel® 6th-Gen Core™ vision controller with vision-specific I/O, real-time control by DTIO V2 and GPU-computing
Nuvis-5306RT-NuMCU	Intel® 6th-Gen Core™ vision controller with vision-specific I/O, real-time control by NuMCU and GPU-computing

Optional Accessories

PA-160W-OW	160W AC/DC power adapter 20V/8A; 18AWGx4C/120cm, cord end terminals for terminal block, operating temperature: -30 to 70 °C.
Fankit-40	Fan assembly for 2-slot Cassette, 40x40x10 mm

Nuvis-534RT Series

AMD Ryzen™ V1000 Ultra-compact Vision Controller with Vision-specific I/O and real-time control



CE FC

Key Features

- AMD Ryzen™ Embedded V1807B quad-core 45W CPU
- Integrated vision-specific I/O
 - 4-CH CC/ CV lighting controller
 - 4-CH camera trigger outputs
 - 1-CH quadrature encoder input
 - 8-CH isolated DI and 8-CH isolated DO
- Patented MCU-based, real-time I/O control by DTIO V2* and NuMCU
- Built-in camera interfaces
 - Four Gigabit PoE+ ports with screw-lock
 - Four USB 3.1 ports with screw-lock
- M.2 2280 M key NVMe (Gen3 x2) socket for fast storage access

Preliminary

*R.O.C Patent No. 1526834

Introduction

Nuvis-534RT is a high-performance, ultra-compact vision controller with integrated camera interfaces, vision-specific I/Os and real-time control for machine vision applications. Powered by AMD Ryzen™ Embedded V1807B 4-core/ 8-thread processor, it provides superb performances equivalent to mainstream desktop CPUs while retaining a compact 8.2 cm x 11.8 cm x 17.6 cm (3.4" x 4.6" x 6.9") dimensions.

Nuvis-534RT offers unique vision-oriented I/O configurations, including constant-current lighting controller to directly drive LED lights, isolated 12V trigger output to activate cameras, encoder input to acquire position information and DIO to connect to sensors/ actuators. All of the above vision-oriented I/Os can be managed by Neousys' patented DTIO V2 or NuMCU technology to guarantee real-time trigger/ response in micro-second scale. The combination of high performance and small footprint gives Nuvis-534RT a distinctive 1-2 punch advantage where the vision system can be easily deployed with USB 3.1 and GigE cameras and without space restrictions.

Specifications

System Core		Storage Interface	
Processor	AMD Ryzen™ V1807B CPU (4C/ 8T, 2M Cache, 3.35/ 3.8 GHz, 35W - 54W TDP)	M.2	1x M.2 2280 M key NVMe socket (PCIe Gen3 x2) for NVMe SSD
Graphics	Vega GPU with 11 compute units	Power Supply	
Memory	Up to 32 GB DDR4-3200 SDRAM by one SODIMM socket	DC Input	1x 3-pin pluggable terminal block for 8 to 35V DC input
TPM	Supports TPM 2.0	Remote Ctrl. & Status Output	1x3-pin pluggable terminal block for remote control and PWR LED output
Vision-Specific I/O Interface		Mechanical	
LED Lighting Controller	4-CH LED lighting controller output, supporting <ul style="list-style-type: none"> - Constant current mode (up to 2 A per channel, 100 kHz dimming control) - Constant voltage mode (24 VDC, 100 kHz dimming control) 	Dimension	82 mm (W) x 118 mm (D) x 176 mm (H)
Camera Trigger	4-CH camera trigger output (isolated 12 VDC output)	Weight	1.5 kg
Encoder Input	1-CH quadrature encoder input (A/ B/ Z)	Mounting	DIN-rail mount (standard) or Wall-mount (optional)
Isolated Digital Output	4-CH isolated high-speed DO (<2 us transient time, for strobe/PWM) 4-CH isolated high-current DO (up to 500 mA rated current for actuator)	Fan	External-accessible 80mm x 80mm fan for system heat dissipation
Isolated Digital Input	8-CH isolated high-speed digital input (<2 us transient time)	Environmental	
Real-time I/O Control	Patented MCU-based real-time I/O control with DTIO V2 or NuMCU firmware	Operating Temperature	-25°C ~ 70°C */**
General I/O Interface		Storage Temperature	-40°C ~ 85°C
Ethernet port	4x Gigabit Ethernet ports by Intel® I350-AM4 controller	Humidity	10%~90%, non-condensing
PoE+	IEEE 802.3at PoE+ PSE, 80 W total power budget	Vibration	Operating, MIL-STD-810G, Method 514.6, Category 4
USB 3.1	4x USB 3.1 Gen1 (5 Gbps) ports	Shock	Operating, MIL-STD-810G, Method 516.6, Procedure I, Table 516.6-II
Video Port	1x VGA, supporting 1920 x 1200 resolution 1x DP connector, supporting 4k2k resolution	EMC	CE/FCC Class A, according to EN 55032 & EN 55024
Serial Port	1x Software-programmable RS-232/422/485 ports (COM1) 3x 3-wire RS-232 ports (COM2/3/4) or 1x RS-422/485 port (COM2)	<small>* For sub-zero and over 60°C operating temperature, a wide temperature HDD or Solid State Disk (SSD) is required.</small> <small>** Operating temperature is up to 70°C only if external-accessible fan is installed.</small>	
Audio	1x 3.5 mm jack for mic-in and speaker-out		

Appearance

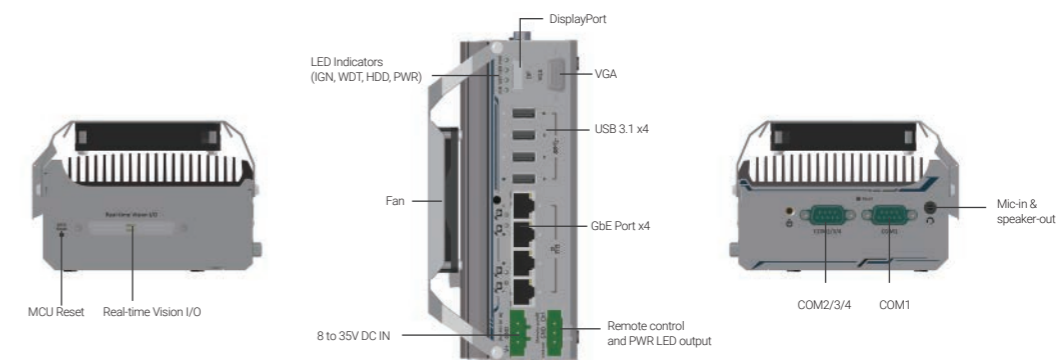

Dimensions

Unit : mm

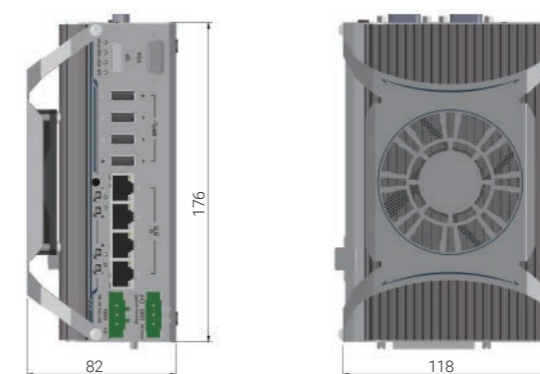

Ordering Information

Model No.	Product Description
Nuvis-534RT-DTIO	AMD Ryzen™ V1807B ultra-compact vision controller with vision-specific I/O and real-time control by DTIO
Nuvis-534RT-NuMCU	AMD Ryzen™ V1807B ultra-compact vision controller with vision-specific I/O and real-time control by NuMCU

LTN-450 Series

4-CH/ 2-CH constant-current LED controller supporting 10A overdriving



Key Features

- Constant current LED lighting control
- 4-CH/ 2-CH LED outputs
 - Up to 2A continuous output, max 180 W rated
 - Up to 10A overdriving output, max 500 W peak
- 4-CH/ 2-CH isolated trigger inputs
- Support versatile operating modes: continuous, pulsed, overdriving and switched
- Support RS-232 and Ethernet interface
- 12 to 35V wide-range DC input



Preliminary

Introduction

LTN-450 series is a constant-current LED lighting controller with overdriving capability. Driving LED light with constant current output offers precise control of light intensity in mA scale and generates stable illumination for machine vision applications.

LTN-450 series provides up to four LED control channels capable of delivering up to 2A current continuously with a total of 180W power budget. It also has four isolated trigger inputs to accept strobe signals from cameras or proximity sensors. In addition, LTN-450 supports 10A overdriving output to strobe the LED with up to 10x brightness for a very short period of time. This gives a burst of 500W peak energy to LED lights and benefits applications such as line scan imaging and high-speed image capture. LTN-450 imposes a patent-pending, MCU-based scheme to rigidly regulate strobe pulse width and overall duty cycle to protect LED lights against burning-out.

The operating mode, output current, trigger source, trigger delay and pulse width can be easily configured via RS-232 or Ethernet interface. A simple GUI utility and cross-platform driver API make it easy to manipulate and control in various applications. LTN-450 series provides a cost-effective way to control the LED where precise and stable illumination matters.

Specifications

	LTN-454	LTN-452
Communication Interface	1x RS-232 COM port 1x Ethernet port	
LED Lighting Controller	4-CH constant current outputs	2-CH LED constant current outputs
Output voltage	Continuous: 5V to 24V Overdriving: 5V to 40V	
Supply voltage	1x 3-pin pluggable terminal block for 12 to 35V DC input	
Output current	Up to 2A in 2.5 mA increments Up to 10A for overdriving in 10 mA increments	
Output power	Up to 180W rated power output for continuous mode Up to 500W peak power output for overdriving mode	
Operating modes	Continuous, pulsed, overdriving and switched modes	
Trigger input	4-CH isolated trigger inputs Logic low: 0V ~ 1.5V Logic high: 5V ~ 24V	2-CH isolated trigger inputs Logic low: 0V ~ 1.5V Logic high: 5V ~ 24V
Pulse width	For overdriving mode: minimum 50 μs in 1 μs increments, maximum 30 ms according to 100% to 1000% overdriving scale For other modes: minimum 400 μs in 1 μs increments	
Pulse Delay	Minimum 0s μs in 1 μs increments	
Operating Temperature	0°C ~ 60°C *	
Dimension	47 mm(W) x 108 mm(D) x 150 mm (H)	
Mounting	DIN-rail mount	
Weight	0.9 kg	
EMC	CE/FCC according to EN61000-6-4&EN61000-6-2	

* Due to various operating modes and current output discrepancies, active cooling may be required.

Appearance

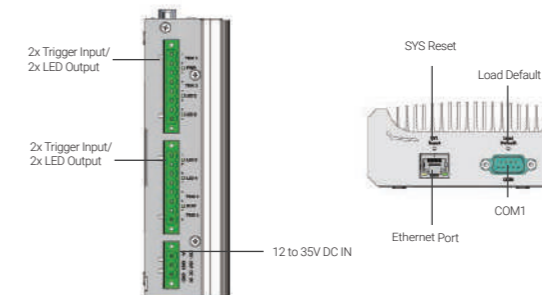

Dimensions

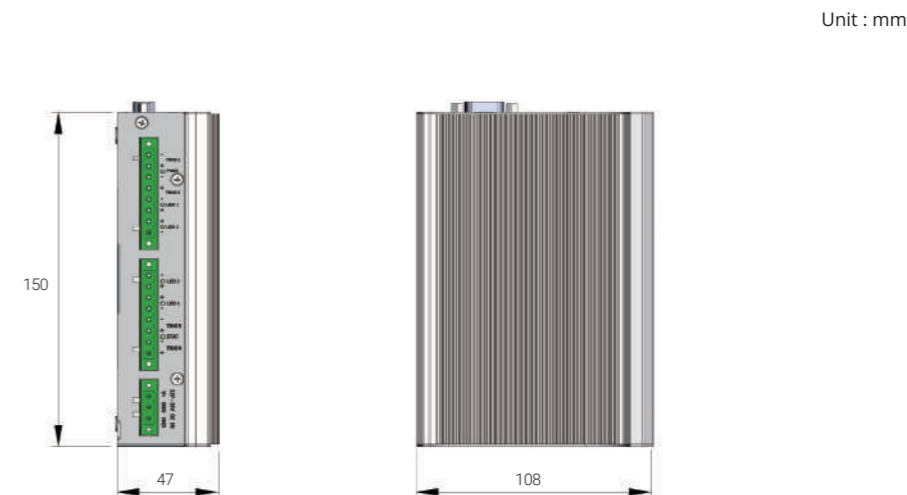

Ordering Information

Model No.	Product Description
LTN-454	4-CH constant-current LED controller supporting 10A overdriving output and 4x trigger inputs
LTN-452	2-CH constant-current LED controller supporting 10A overdriving output and 2x trigger inputs

Optional Accessories

PA-280W-ET2	280W AC/ DC power adapter 24V/ 11.67A; 16AWG/ 100cm; cord end terminals for terminal block, operating temperature : -30°C to 60°C.
PA-480W-DIN	480W AC/ DC power adapter DIN-rail mount, 24V 20A, 90~264VAC/ 127~370VDC, terminal block, -20 to70°C

PCIe-PoE454 Series

4-port 5GBASE-T Ethernet 802.3at PoE+ Frame Grabber Card



CE FC

Key Features

- 4x IEEE 802.3bz 5GBASE-T Ethernet ports by four Marvel AQC111C controllers
- Compliant with IEEE 802.3at to deliver up to 25.5 W for each port
- Supports 5G/ 2.5G/ 1G/ 100M link speed
- x4, Gen3 PCI Express interface offering 4GB/s total bandwidth
- Per-port PoE+ power on/ off control
- Compatible with COTS NBASE-T industrial cameras

Introduction

PCIe-PoE454at is an industrial-grade 4-port 5GBASE-T frame grabber card with 802.3at PoE+ capability for advanced machine vision applications. It leverages Marvel AQC111C 5GBASE-T Ethernet controller to offer dedicated 5 Gb/s Ethernet bandwidth for each port. Furthermore, it is backward compatible with 2.5G, 1G, 100M link speeds to support legacy Ethernet devices and can transmit data utilizing economical Cat 5e Ethernet cables up to 100 meters without bandwidth degradation.

5GBASE-T, or NBASE-T, is an emerging technology, especially for the machine vision market. Cameras with a 5GBASE-T Ethernet interface have up to 5 times the Ethernet bandwidth compared to Gigabit Ethernet, thus supporting higher resolution and frame rate. PCIe-PoE454at provides high port density to provide four 5GbE ports in a standard half-size PCIe card form factor. In addition, it comes with IEEE 802.3at PoE+ PSE function so you can simply power the NBASE-T camera using a single Ethernet cable.

For machine vision systems requiring multiple high-resolution 5GBASE-T cameras, PCIe-PoE454at is the ideal frame grabber that provides high port density, 24/7 reliable operation, and excellent throughput performance without frame loss.

Specifications

	PCIe-PoE454at	PCIe-N452
Bus Interface	4-lanes, Gen3 PCI Express interface, compliant with PCI Express Base Specification Revision 3.0	
# of 5G Port	4x 5GBASE-T Ethernet ports by four Marvel AQC111C 5G controllers, supporting 5G, 2.5G, 1G, 100M link speed	2x 5GBASE-T Ethernet ports by four Marvel AQC111C 5G controllers, supporting 5G, 2.5G, 1G, 100M link speed
PoE Capability	In compliance with IEEE 802.3at-2009 (PoE+), each port delivers up to 25.5 W of power	-
Ethernet Connector	4x RJ-45 connectors	2x RJ-45 connectors
Cable Requirement	CAT-5e or CAT-6 cable, 100 meters maximum	
Power Requirement	Maximum 5.5 A@12V (66W) from PCIe gold finger connector Maximum 8.5 A@12V (102W) with onboard 6-pin PCIe power connector connected	
EMC	CE Class A, according to EN 55032/55035 FCC Class A, according to FCC Part 15, Subpart B	
Operating Temperature	0°C ~ 55°C with airflow	
Dimension	167.7 mm (W) x 111.2 mm (H)	

Ordering Information

Model No.	Product Description
PCIe-PoE454at	4-port 5GBASE-T Ethernet 802.3at PoE+ Machine Vision Frame Grabber Card
PCIe-N452	2-port 5GBASE-T Ethernet Machine Vision Frame Grabber card

PCIe-PoE550X

2-port 10GbE Network Adapter with IEEE 802.3at PoE+



CE FC

Key Features

- Two 10 GbE ports by Intel® X550-AT2 10 GigE controller
- Gen3 PCI Express x4 interface
- Supports 10GbE with CAT-6/ 6a cable (Max. 100 meters)
- Supports 802.3at PoE+ with CAT 6a cable
- Supports NBASE-T and 1000BASE-T with CAT-5/ 5e cable
- Compliant with IEEE 802.3at to deliver 25.5W each port
- Supports 15.5 KB jumbo frame, NIC teaming and IEEE 1588
- Per-port PoE+ power on/off control via API

Introduction

Introducing the world's first 10Gbit Ethernet NIC incorporating IEEE 802.3at PoE+ capability, featuring Intel® X550-AT2, Neosys Technology's PCIe-PoE550X offers cost-effective 10GBASE-T solution for growing 10GbE applications.

PCIe-PoE550X features 10GbE NIC incorporating Power over Ethernet (PoE+) capability. It features Neosys' proven 802.3at PoE+ technology and refined power design to ensure optimal signal integrity over 10G PHY and maximal bandwidth. The combination of 10GbE and PoE opens the door to new applications such as high-performance WiFi access points and high-speed/ high-definition industrial cameras over single Ethernet cable.

10GBASE-T leverages twisted-pair copper cable and RJ45 connector that dramatically reduces the deployment cost of 10G network. PCIe-PoE550X provides 10Gbit/s connections over a distance of up to 100 meters with CAT 6a cable or 55 meters with CAT 6 cable. It also supports upcoming NBASE-T standard as well as backward compatibility with existing 1000BASE-T GbE network so you can easily implement it into your current network infrastructure.

Specifications

Bus Interface	Gen3 PCI Express x4
# of 10 GbE Port	2x 10 GbE ports by Intel® X550-AT2 controller, supporting 15.5 KB Jumbo frame, teaming and IEEE 1588
Network Protocol Support	IEEE 802.3 Ethernet interface for 10GBASE-T (IEEE 802.3an), NBASE-T (IEEE 802.3bz) and 1000BASE-T (IEEE 802.3ab)
PoE Capability	Optional IEEE 802.3at-2009 (PoE+), up to 25.5W per port
Cable Requirement	For 10GBASE-T: CAT 6a (100 meters) or CAT 6 (55 meters) For 5 Gbps NBASE-T: CAT 6 (100 meters) For 2.5 Gbps NBASE-T: CAT 5e (100 meters)
Power Requirement	Maximum 11.5W for 2x 10 GbE operation Maximum 51W for powering PoE+ devices
EMC	CE Class A, according to EN 55024/ 55032 FCC Class A, according to FCC Part 15, Subpart B
EMS	IEC 61000-4-x Class/ Level 3
Operating Temperature	0°C ~ 60°C with air flow
Dimension	168 mm (W) x 111.2 mm (H)

Ordering Information

Model No.	Product Description
PCIe-PoE550X	2-port 10GbE Network Adapter with IEEE 802.3at PoE+
PCIe-10G550X	2-port 10GbE Network Adapter

PCIe-PoE334LP

Low-profile 4-port Server-grade Gigabit PoE+ Card with 1 kV Surge Protection

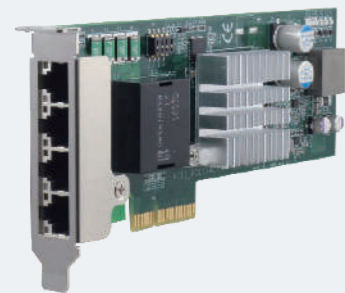

CE FC

Key Features

- Low-profile form-factor
- 4x ports via Intel® I350-AM4 server-grade GigE controller
- Compliant with IEEE 802.3at to deliver 25.5 W each port
- IEC 61000-4-5 Class 2 surge immunity
- Supports 9.5 kB jumbo frame, teaming and IEEE 1588
- Per-port PoE+ power on/ off control via software API

Introduction

PCIe-PoE334LP is the latest member of Neosys' PoE NIC card family. It is the world's first PoE card to integrate 4-port server-grade GigE controller and 802.3at PoE+ into a low-profile PCIe card. The low-profile form-factor makes PCIe-PoE334LP the perfect solution for commercial off-the-shelf 2U server computers.

PCIe-PoE334LP is designed with Intel® I350-AM4 GigE controller to offer extraordinary Ethernet performance. It inherits Neosys' proven PoE technology to power your machine vision cameras and surveillance IP cameras. In addition, PCIe-PoE334LP features solid surge protection design compliant with IEC 61000-4-5 Class 2. It is capable of withstanding 1 kV surge and 8 kV ESD on signal lines. This is particularly valuable for outdoor surveillance system or factory automation equipment where power surge may damage the system through the Ethernet connection.

Incorporating low-profile form-factor and robust surge protection, PCIe-PoE334LP defines a new category of PoE card - a compact and yet solid PoE card for servers and rugged industrial applications.

Specifications

Bus Interface	x4, Gen2 PCI Express
Gigabit Ethernet Port	4x GigE ports by Intel® I350-AM4 controller, supporting 9.5 kB jumbo frame, teaming and IEEE 1588
PoE Capability	In compliance with IEEE 802.3at-2009 (PoE+), each port delivers up to 25.5 W of power 75W total power budget (limited by PCI Express bus)
Cable Requirement	CAT-5e or CAT-6 cable, 100 meters maximal
Power Requirement	Maximum 1.2 A @ 3.3 V from PCI Express bus Maximum 6.2A @ 12 V from PCI Express bus
EMC	CE Class A, according to EN 55022/ 55024/ 55032 FCC Class A, according to FCC Part 15, Subpart B
EMS	IEC 61000-4-x Class/ Level 2
Operating Temperature	0°C ~ 55°C with air flow
Dimension	168 mm (W) x 69 mm (H)

Ordering Information

Model No.	Product Description
PCIe-PoE334LP	Low-profile 4-port server-grade Gigabit 802.3at PoE+ card with 1 kV surge protection

PCIe-PoE354at/PoE352at

4-Port / 2-Port Server-grade Gigabit 802.3at PoE+ Frame Grabber Card

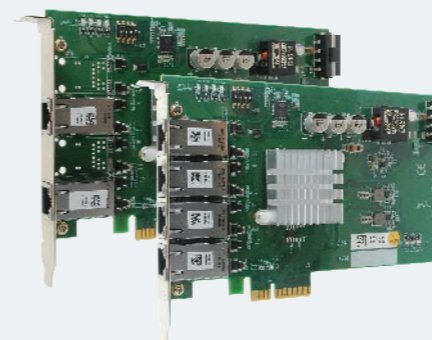

CE FC

Key Features

- x4, Gen2 PCI Express interface (2GB/s total bandwidth)
- Intel® I350 server-grade Gigabit Ethernet controller
- Supports four (354at) or two (352at) independent GigE ports
- Compliant with IEEE 802.3at to deliver 25.5 W each port
- Supports 9.5 kB jumbo frame, teaming and IEEE 1588
- Per-port PoE+ power on/ off control

Introduction

PCIe-PoE354at is world's first PoE frame grabber card combining server-grade GigE controller and 802.3at PoE+ capability. Inheriting Neosys' expertise on PoE technology, PCIe-PoE354at further incorporates the updated 802.3at-2009 standard and offers up to 25.5W of power each port.

PCIe-PoE354at is designed with Intel® I350 Gigabit Ethernet controller. This server-grade GigE controller incorporates advanced features such as checksum offloading, segmentation offloading and intelligent interrupt generation/ moderation to increase overall Ethernet performance and reduce CPU utilization. In addition, its single-bus, multi-port topology minimizes compatibility issues with off-the-shelf motherboards when installing multiple cards.

Machine vision applications can be benefited by PCIe-PoE354at's server-grade network performance. Its 25.5W PoE+ can now power PTZ (pan-tilt-zoom) cameras for surveillance applications. With an excellent cost-per-performance ratio, PCIe-PoE354at is your ideal Power over Ethernet solution.

Specifications

	PCIe-PoE354at	PCIe-PoE352at
Bus Interface	x4, Gen2 PCI Express	
Gigabit Ethernet Port	4x GigE ports by Intel® I350-AM4 controller, supporting 9.5 kB jumbo frame, teaming and IEEE 1588	2x GigE ports by Intel® I350-AM2 controller, supporting 9.5 kB jumbo frame, teaming and IEEE 1588
PoE Capability	In compliance with IEEE 802.3at-2009 (PoE+), each port delivers up to 25.5 W of power	
Cable Requirement	CAT-5e or CAT-6 cable, 100 meters maximum	
Power Requirement	Maximum 1.2A @ 3.3V from PCI Express bus Maximum 5.5A @ 12V from PCI Express bus or on-board 4-pin power connector*	Maximum 0.9A @ 3.3V from PCI Express bus Maximum 4.8A @ 12V from PCI Express bus**
Operating Temperature	0°C ~ 55°C	
Dimension	168 mm (W) x 111 mm (H)	

* PCIe-PoE354at is designed to obtain 12 VDC for PoE devices from either PCI Express bus or on-board 4-pin power connector according to a user-configurable jumper.
** PCIe-PoE352at is designed to obtain 12 VDC for PoE devices directly from PCI Express bus. No external 12 VDC is needed.

Ordering Information

Model No.	Product Description
PCIe-PoE354at	4-Port Intel® I350-AM4 server-grade Gigabit 802.3at PoE+ frame grabber card
PCIe-PoE352at	2-Port Intel® I350-AM2 server-grade Gigabit 802.3at PoE+ frame grabber card

PCIe-USB381F

8-Port USB 3.1 Gen1 Frame Grabber Card with 4x Independent USB Controllers

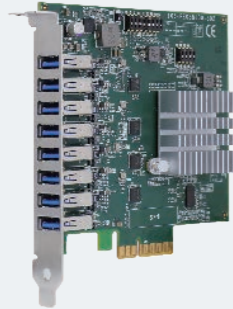

CE FC

Key Features

- x4 PCI Express® Gen2 interface (2GB/s total bandwidth)
- 8x USB 3.1 Gen1 ports by 4x Fresco FL1100SX xHCI controllers
- Onboard 5VDC regulated power supply, no external power needed
- User-configurable 900mA and 1800mA current limit
- Software-programmable per-port power on/off control*
- Supports Windows 7/10 operating systems

Introduction

Neousys PCIe-USB381F is an industrial-grade 8-port USB 3.1 Gen1 (formerly USB 3.0) frame grabber card for machine vision applications. Featuring x4 PCI Express Gen2 interface and four Fresco FL1100SX xHCI controllers, PCIe-USB381F can provide up to 400MB/s sustained data transfer rate per port with four USB3 cameras operating simultaneously, or provide a total bandwidth of 1600MB/s when eight cameras are plugged in.

All eight USB ports of PCIe-USB381F are accessible on the faceplate for easy cabling. Each port can deliver standard 900mA regulated 5V output to power USB3 cameras or user-configurable 1800mA output via onboard jumpers for devices that require higher power consumption. It also supports software-programmable per-port power on/off control to reset cameras or other devices for fault recovery.

The steady 400 MB/s data throughput satisfies the bandwidth requirement of most off-the-shelf industrial USB3 cameras. Pairing reliable 5 VDC power output and per-port on/off control, PCIe-USB381F can benefit a variety of vision-related applications such as machine vision, factory automation and medical imaging.

Specifications

USB Ports	8x USB 3.1 Gen1 ports, compatible with USB 2.0/ 1.1/ 1.0
USB Connectors	8x panel-accessible Type-A USB3 connectors
Bus Interface	4-lanes, Gen2 PCI Express interface, compliant with PCI Express Base Specification Revision 2.0
USB3 Host Controller	4x Fresco FL1100SX host controllers, compliant with Intel® xHCI Specification Revision 1.0
Per-Port Current Limit	User-configurable 900mA/ 1800mA per-port current limit
Power Requirement	Maximal 2.0 A@3.3V from PCI Express bus Maximal 5.5 A@12V from PCI Express bus for all connected USB devices
Operating Temperature	0 ~ 60°C with ambient airflow
Dimension	117.7 mm (W) x 111.2 mm (H)

Ordering Information

Model No.	Product Description
PCIe-USB381F	8-Port USB 3.1 Gen1 frame grabber card with 4x independent USB3 controllers

* Support software-programmable per-port power on/ off control for port 0/ 2/ 3/ 4/ 5/ 6/ 7



In-vehicle Computing



Nuvo-7200VTC Series

Intel® 9th/ 8th-Gen Core™ In-vehicle Controller with 4x or 8x PoE+ Ports, Single-slot PCIe Cassette



Key Features

- Supports Intel® 9th/ 8th-Core™ i7/ i5/ i3 LGA1151 socket-type CPU
- Patented Cassette for PCIe add-on card accommodation*
- 4x or 8x 802.3at Gigabit PoE+ ports via M12 or RJ45 connectors
- Onboard isolated CAN bus for in-vehicle communication
- 4-CH isolated DI and 4-CH isolated DO
- 2x hot-swappable SATA HDD trays, supporting RAID 0/1
- 2x M.2 B key and 3x full-size mini-PCIe sockets
- 8 to 35V wide-range DC input with built-in ignition power control
- E-Mark and EN 50155/ EN 45545 certificate



*R.O.C Patent No. M456527

Introduction

Nuvo-7200VTC is the latest rugged in-vehicle controller featuring purpose-built set and effortless connectivity, powered by Intel® 9th/ 8th-Gen Core™ processors with up to 6-core/ 8-core architecture and 64GB DDR4 memory that gets a significant performance increase over previous generations.

Nuvo-7200VTC provides flexibility to support a range of peripherals and connections. It has four or eight 802.3at PoE+ ports to supply 25W power to connected devices via M12 or RJ-45 connectors. Screw-lock mechanisms on GbE and USB 3.1 ports guarantee extreme rugged connectivity in shock/ vibration environments. Wireless connectivity is essential for modern in-vehicle applications and you can simultaneously utilize two M.2 and three mini-PCIe sockets with corresponding 3G/ 4G, WIFI, GPS, and CAN module for this purpose. Additionally, Neosys provides an option of 4G cellular module certified to work with renowned US telecom company to minimize implementation time and cost.

Thanks to Neosys' patented Cassette design, it has one additional PCIe slot in the Cassette module for an add-on card installation, making it that much more flexible. Nuvo-7200VTC also features two hot-swappable HDD trays, isolated CAN bus, isolated DIO, 8 to 35V wide-range DC input with ignition power control and is in compliance with E-Mark and EN 50155/ EN45545. The Nuvo-7200VTC is the perfect solution with extraordinary reliability for various in-vehicle application needs.

Specifications

System Core		Expansion Bus	
Processor	Supporting Intel® 9th/ 8th-Gen Core™ CPU (LGA1151 socket, 35W TDP) - Intel® Core™ i7-9700TE/ i7-8700T - Intel® Core™ i5-9500TE/ i5-8500T - Intel® Core™ i3-9100TE/ i3-8100T	PCI Express	1x PCIe x16 slot@Gen3, 16-lanes PCIe signals in Cassette
Chipset	Intel® Q370 platform controller hub	Mini PCI-E	1x full-size mini PCI Express socket with internal SIM socket (mux with mSATA) 2x full-size mini-PCIe sockets (USB signals only) with internal SIM sockets
Graphics	Integrated Intel® UHD Graphics 630	M.2	2x M.2 2242 B key socket, one with dual front-accessible SIM sockets, supporting dual SIM mode with selected M.2 LTE module
Memory	Up to 64 GB DDR4 2666/ 2400 SDRAM (two SODIMM slots)	Power Supply	
AMT	Supports AMT 12.0	DC Input	1x 3-pin pluggable terminal block for 8 to 35V DC input (IGN/ GND/ V+)
TPM	Supports TPM 2.0	Remote Ctrl. & Status Output	1x 3-pin pluggable terminal block for remote control and PWR LED output
I/O Interface		Mechanical	
Ethernet	2x Gigabit Ethernet ports by Intel® I219 and I210	Dimension	240 mm (W) x 225 mm (D) x 103mm (H)
PoE+	4x IEEE 802.3at (25.5W) Gigabit PoE+ ports by Intel® I210 - M12 x-coded connector (Nuvo-7200VTC); - RJ45 connector (Nuvo-7204VTC) 8x IEEE 802.3at (25.5W) Gigabit PoE+ ports by Intel® I210 - RJ45 connector (Nuvo-7208VTC)	Weight	3.7 kg
CAN	1x isolated CAN 2.0 port	Mounting	Wall-mount with damping brackets (Standard) or DIN-rail mount (optional)
Isolated DIO	4x isolated DI and 4x isolated DO	Environmental	
USB 3.1	4x USB 3.1 Gen2 (10 Gbps) ports 4x USB 3.1 Gen1 (5 Gbps) ports	Operating Temperature	-40°C ~ 70°C **/***
Video Port	1x VGA, supporting 1920 x 1200 resolution 1x DVI-D, supporting 1920 x 1200 resolution 1x DisplayPort, supporting 4096 x 2304 resolution	Storage Temperature	-40°C ~ 85°C
Serial Port	2x software-programmable RS-232/422/485 ports (COM1/ COM2) 2x RS-232 ports (COM3/ COM4)	Humidity	10%~90% , non-condensing
Audio	1x mic-in and 1x speaker-out	Vibration	IEC61373:2010, Category 1, Class B Body mounted (part of EN50155)
Storage Interface		Shock	IEC61373:2010, Category 1, Class B Body mounted (part of EN50155)
SATA HDD	2x hot-swappable HDD tray for 2.5" HDD/ SSD installation, supporting RAID 0/1	EMC	EN 50155, E-Mark CE/FCC Class A, according to EN 55032 & EN 55024
mSATA	1x full-size mSATA port (mux with mini-PCIe)	** For i7-9700E and i7-8700 running at 65W mode, the highest operating temperature shall be limited to 50°C and thermal throttling may occur when sustained full-loading applied. Users can configure CPU power in BIOS to obtain higher operating temperature.	
M.2	1x M.2 2280 M key socket (PCIe Gen3 x4) for NVMe SSD or Intel® Optane™ memory installation	*** For sub-zero operating temperature, a wide temperature HDD or Solid State Disk (SSD) is required.	

Appearance

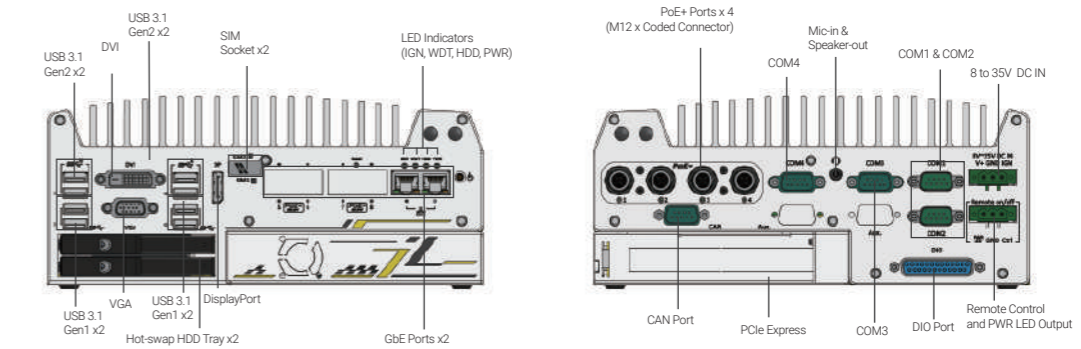

Dimensions

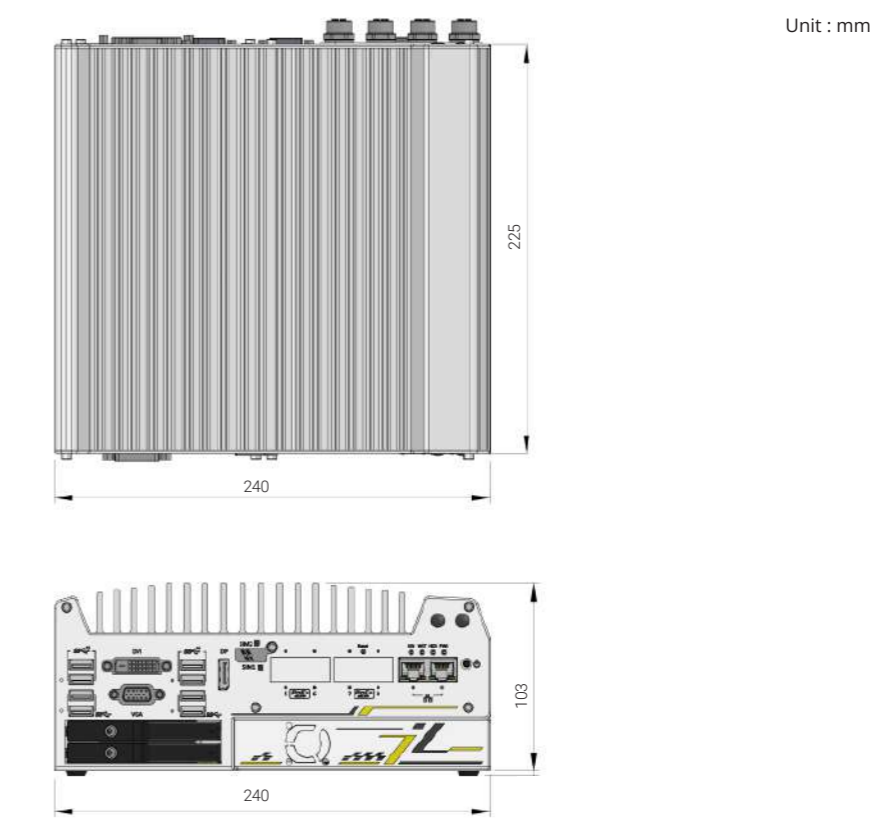

Ordering Information

Model No.	Product Description
Nuvo-7200VTC	Intel® 9th/8th-Gen Core™ in-vehicle controller with 4x M12 PoE+ ports, DIO, CAN bus and RAID, single-slot PCI Express Cassette
Nuvo-7204VTC	Intel® 9th/8th-Gen Core™ in-vehicle controller with 4x RJ45 PoE+ ports, DIO, CAN bus and RAID, single-slot PCI Express Cassette
Nuvo-7208VTC	Intel® 9th/8th-Gen Core™ in-vehicle controller with 8x RJ45 PoE+ ports, DIO, CAN bus and RAID, single-slot PCI Express Cassette

Optional Accessories

Cbl-M12X8M-RJ45-500CM	M12 (8-pole-X-coded) to RJ45, CAT6, length : 500CM
Cbl-M12X8M-RJ45-1000CM	M12 (8-pole-X-coded) to RJ45, CAT6, length : 1000CM
PA-120W-OW	120W AC/DC power adapter 20V/6A; 18AWG/120cm; cord end terminals for terminal block, operating temperature : -30°C to 70 °C.

Optional Cellular Module

NSIO-LTE-7455	Cat. 6 LTE embedded socket modem
----------------------	----------------------------------

Nuvo-7250VTC Series

Intel® 9th/ 8th-Gen Core™ In-vehicle Controller with 4x or 8x PoE+ Ports, Supercapacitor-based Power Backup Module



CE FC E13 10R-0615583

Key Features

- Supports Intel® 9th/ 8th-Gen Core™ i7/ i5/ i3 LGA1151 socket-type CPU
- Patented supercapacitor-based uninterruptible power backup*
- 4x or 8x 802.3at Gigabit PoE+ ports via M12 or RJ45 connectors
- Onboard isolated CAN bus for in-vehicle communication
- 4-CH isolated DI and 4-CH isolated DO
- 2x hot-swappable SATA HDD trays, supporting RAID 0/ 1
- 2x M.2 B key and 3x full-size mini-PCIe sockets
- 8 to 35V wide-range DC input with built-in ignition power control
- E-Mark and EN 50155/ EN 45545 certificate

*R.O.C Patent No. M456527/ I598820

Introduction

Nuvo-7250VTC is a rugged in-vehicle controller that utilizes Neosys' innovative supercapacitor-based power backup solution. Powered by Intel® 9th/ 8th-Gen Core™ processors with up to 6-core/ 8-core and 64GB DDR4 memory, it offers over 50% performance increase over previous generations. Nuvo-7250VTC is equipped with supercapacitor technology to provide 2500 watt-second stored energy to sustain the system to safely shutdown during unforeseen power outages.

Nuvo-7250VTC offers a variety of peripherals and connections. It has four or eight 802.3at PoE+ ports to supply 25W power to connected devices via M12 or RJ-45 connectors. Screw-lock mechanisms on GbE and USB 3.1 ports guarantee extreme rugged connectivity in shock/ vibration environments. Internal expansion wise, it has two M.2 and three mini-PCIe sockets for corresponding modules such as 3G/ 4G, WIFI, GPS, and CAN module. Additionally, Neosys provides an option of 4G cellular module certified to work with renowned US telecom company to minimize implementation time and cost.

To top it off, Nuvo-7250VTC also features two hot-swappable HDD trays, isolated CAN bus, isolated DIO, 8 to 35V wide-range DC input with ignition power control and is in compliance with E-Mark and EN 50155/ EN45545. Coupled with supercapacitor power backup technology, the Nuvo-7250VTC offers data protection and is the perfect solution for various in-vehicle applications.

Specifications

System Core		Expansion Bus	
Processor	Supporting Intel® 9th/ 8th-Gen Core™ CPU (LGA1151 socket, 35W TDP) - Intel® Core™ i7-9700TE/ i7-8700T - Intel® Core™ i5-9500TE/ i5-8500T - Intel® Core™ i3-9100TE/ i3-8100T	Mini PCI-E	1x full-size mini PCI Express socket with internal SIM socket (mux with mSATA) 2x full-size mini-PCIe sockets (USB signals only) with internal SIM sockets
Chipset	Intel® Q370 platform controller hub	M.2	2x M.2 2242 B key socket, one with dual front-accessible SIM sockets, supporting dual SIM mode with selected M.2 LTE module
Graphics	Integrated Intel® UHD Graphics 630	Power Supply	
Memory	Up to 64 GB DDR4 2666/ 2400 SDRAM (two SODIMM slots)	DC Input	1x 3-pin pluggable terminal block for 8 to 35V DC input (IGN/ GND/ V+)
AMT	Supports AMT 12.0	Remote Ctrl. & Status Output	1x 3-pin pluggable terminal block for remote control and PWR LED output
TPM	Supports TPM 2.0	Power Backup	
I/O Interface		Capacity	2500 watt-second
Ethernet	2x Gigabit Ethernet ports by Intel® I219 and I210	Mechanical	
PoE+	4x IEEE 802.3at (25.5W) Gigabit PoE+ ports by Intel® I210 - M12 x-coded connector (Nuvo-7250VTC); - RJ45 connector (Nuvo-7254VTC) 8x IEEE 802.3at (25.5W) Gigabit PoE+ ports by Intel® I210 - RJ45 connector (Nuvo-7258VTC)	Dimension	240 mm (W) x 225 mm (D) x 103mm (H)
CAN	1x isolated CAN 2.0 port	Weight	4.1 kg
Isolated DIO	4x isolated DI and 4x isolated DO	Mounting	Wall-mount with damping brackets (Standard) or DIN-rail mount (optional)
USB 3.1	4x USB 3.1 Gen2 (10 Gbps) ports 4x USB 3.1 Gen1 (5 Gbps) ports	Environmental	
Video Port	1x VGA, supporting 1920 x 1200 resolution 1x DVI-D, supporting 1920 x 1200 resolution 1x DisplayPort, supporting 4096 x 2304 resolution	Operating Temperature	-40°C ~ 70°C **/**
Serial Port	2x software-programmable RS-232/422/485 ports (COM1/ COM2) 2x RS-232 ports (COM3/ COM4)	Storage Temperature	-40°C ~ 85°C
Audio	1x mic-in and 1x speaker-out	Humidity	10%~90%, non-condensing
Storage Interface		Vibration	IEC61373:2010, Category 1, Class B Body mounted (part of EN50155)
SATA HDD	2x hot-swappable HDD tray for 2.5" HDD/ SSD installation, supporting RAID 0/ 1	Shock	IEC61373:2010, Category 1, Class B Body mounted (part of EN50155)
mSATA	1x full-size mSATA port (mux with mini-PCIe)	EMC	E-Mark, EN 50155, EN45545(Nuvo-7258VTC), CE/FCC Class A, according to EN 55032 & EN 55024
M.2	1x M.2 2280 M key socket (PCIe Gen3 x4) for NVMe SSD or Intel® Optane™ memory installation	** For i7-9700E and i7-8700 running at 65W mode, the highest operating temperature shall be limited to 50°C and thermal throttling may occur when sustained full-loading applied. Users can configure CPU power in BIOS to obtain higher operating temperature. *** For sub-zero operating temperature, a wide temperature HDD or Solid State Disk (SSD) is required.	

Appearance

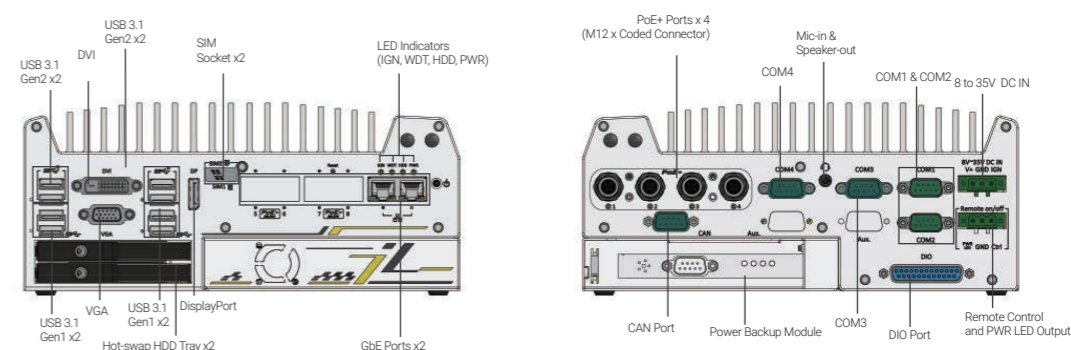

Dimensions

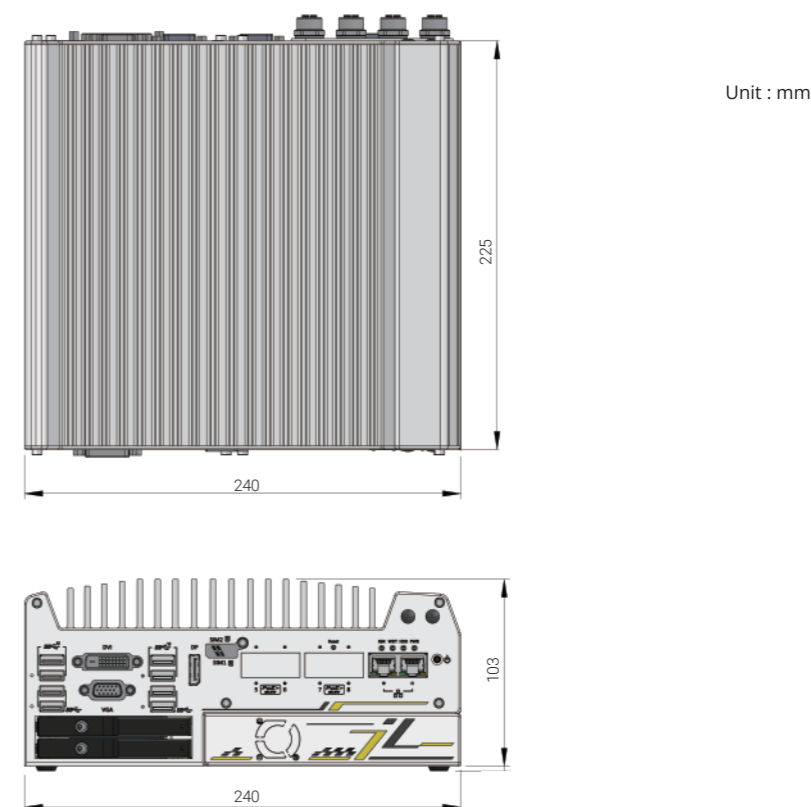

Ordering Information

Model No.	Product Description
Nuvo-7250VTC	Intel® 9th/ 8th-Gen Core™ in-vehicle controller with 4x M12 PoE+ ports, ultracapacitor-based power backup module
Nuvo-7254VTC	Intel® 9th/ 8th-Gen Core™ in-vehicle controller with 4x RJ45 PoE+ ports, ultracapacitor-based power backup module
Nuvo-7258VTC	Intel® 9th/ 8th-Gen Core™ in-vehicle controller with 8x RJ45 PoE+ ports, ultracapacitor-based power backup module

Optional Accessories

Cbl-M12X8M-RJ45-500CM	M12 (8-pole-X-coded) to RJ45, CAT6, length : 500CM
Cbl-M12X8M-RJ45-1000CM	M12 (8-pole-X-coded) to RJ45, CAT6, length : 1000CM
PA-120W-OW	120W AC/DC power adapter 20V/6A; 18AWG/120cm; cord end terminals for terminal block, operating temperature : -30 to 70 °C.

Optional Cellular Module

NSIO-LTE-7455	Cat. 6 LTE embedded socket modem
---------------	----------------------------------

Nuvo-7100VTC Series

Intel® 9th/ 8th-Gen Core™ i7/i5/i3 In-vehicle Controller with 4x or 8x PoE+ Ports, DIO, CAN bus and RAID

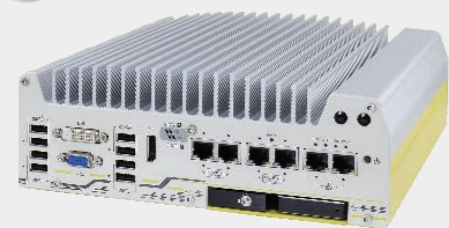

Key Features

- Supports Intel® 9th/8th-Gen Core™ i7/i5/i3 LGA1151 socket-type CPU
- 4x or 8x 802.3at Gigabit PoE+ ports via M12 or RJ45 connectors
- Onboard isolated CAN bus for in-vehicle communication
- 4-CH isolated DI and 4-CH isolated DO
- 2x SATA ports with one hot-swappable HDD tray, supporting RAID 0/ 1
- 2x M.2 B key and 3x full-size mini-PCIe sockets
- 8 to 35V wide-range DC input with built-in ignition power control
- E-Mark and EN 50155/ EN 45545 certificate

Introduction

Nuvo-7100VTC is a rugged in-vehicle controller featuring purpose-built set and effortless connectivity. Powered by Intel® 9th/ 8th-Gen Core™ processors with up to 6-core/ 8-core and 64GB DDR4 memory, it provides significant performance increases over previous generations.

Nuvo-7100VTC provides flexibility to support a range of peripherals and connections. It has four or eight 802.3at PoE+ ports to supply 25W power to connected devices via M12 or RJ-45 connectors. Screw-lock mechanisms on GbE and USB 3.1 ports guarantee extreme rugged connectivity in shock/ vibration environments. Wireless connectivity is essential for modern day in-vehicle applications and you can simultaneously utilize two M.2 and three mini-PCIe sockets with corresponding 3G/ 4G, WIFI, GPS, and CAN module for this purpose. Additionally, Neousys provides an option of 4G cellular module certified to work with renowned US telecom company to minimize implementation time and cost.

On top of all that, Nuvo-7100VTC also features isolated CAN bus, isolated DIO, 8 to 35V wide-range DC input with ignition power control and is in compliance with E-Mark and EN 50155. The Nuvo-7100VTC is the perfect solution with extraordinary reliability for various in-vehicle applications.

Specifications

System Core		Expansion Bus	
Processor	Supporting Intel® 9th/ 8th-Gen Core™ CPU (LGA1151 socket, 35W TDP) - Intel® Core™ i7-9700TE/ i7-8700T - Intel® Core™ i5-9500TE/ i5-8500T - Intel® Core™ i3-9100TE/ i3-8100T	Mini PCI-E	1x full-size mini PCI Express socket with internal SIM socket (mux with mSATA) 2x full-size mini-PCIe sockets (USB signals only) with internal SIM sockets
Chipset	Intel® Q370 platform controller hub	M.2	2x M.2 2242 B key socket, one with dual front-accessible SIM sockets, supporting dual SIM mode with selected M.2 LTE module
Graphics	Integrated Intel® HD Graphics 630	Power Supply	
Memory	Up to 64 GB DDR4 2666/ 2400 SDRAM (two SODIMM slots)	DC Input	1x 3-pin pluggable terminal block for 8 to 35V DC input (IGN/ GND/ V+)
AMT	Supports AMT 12.0	Remote Ctrl. & Status Output	1x 3-pin pluggable terminal block for remote control and PWR LED output
TPM	Supports TPM 2.0	Mechanical	
I/O Interface		Dimension	240 mm (W) x 225 mm (D) x 84 mm (H)
Ethernet	2x Gigabit Ethernet ports by Intel® I219 and I210	Weight	3.5 kg
PoE+	4x IEEE 802.3at (25.5W) Gigabit PoE+ ports by Intel® I210 - M12 x-coded connector (Nuvo-7100VTC); - RJ45 connector (Nuvo-7104VTC) 8x IEEE 802.3at (25.5W) Gigabit PoE+ ports by Intel® I210 - RJ45 connector (Nuvo-7108VTC)	Mounting	Wall-mount with damping brackets (Standard) or DIN-rail mount (optional)
CAN	1x isolated CAN 2.0 port	Environmental	
Isolated DIO	4x isolated DI and 4x isolated DO	Operating Temperature	-40°C ~ 70°C */**
USB 3.1	4x USB 3.1 Gen2 (10 Gbps) ports 4x USB 3.1 Gen1 (5 Gbps) ports	Storage Temperature	-40°C ~ 85°C
Video Port	1x VGA, supporting 1920 x 1200 resolution 1x DVI-D, supporting 1920 x 1200 resolution 1x DisplayPort, supporting 4096 x 2304 resolution	Humidity	10%~90% , non-condensing
Serial Port	2x software-programmable RS-232/422/485 ports (COM1/ COM2) 2x RS-232 ports (COM3/ COM4)	Vibration	IEC61373:2010, Category 1, Class B Body mounted (part of EN50155)
Audio	1x mic-in and 1x speaker-out	Shock	IEC61373:2010, Category 1, Class B Body mounted (part of EN50155)
Storage Interface		EMC	EN 50155, E-Mark CE/FCC Class A, according to EN 55022 & EN 55024
SATA HDD	1x hot-swappable HDD tray for 2.5" HDD/ SSD installation 1x Internal SATA port for 2.5" HDD/ SSD installation, supporting RAID 0/ 1	* For i7-9700E and i7-8700 running at 65W mode, the highest operating temperature shall be limited to 50°C and thermal throttling may occur when sustained full-loading applied. Users can configure CPU power in BIOS to obtain higher operating temperature. ** For sub-zero operating temperature, a wide temperature HDD or Solid State Disk (SSD) is required.	
mSATA	1x full-size mSATA port (mux with mini-PCIe)		
M.2	1x M.2 2280 M key socket (PCIe Gen3 x4) for NVMe SSD or Intel® Optane™ memory installation		

Appearance

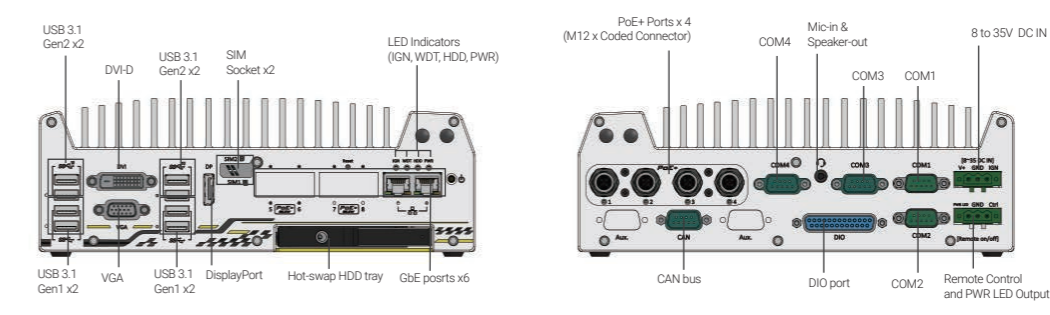

Dimensions

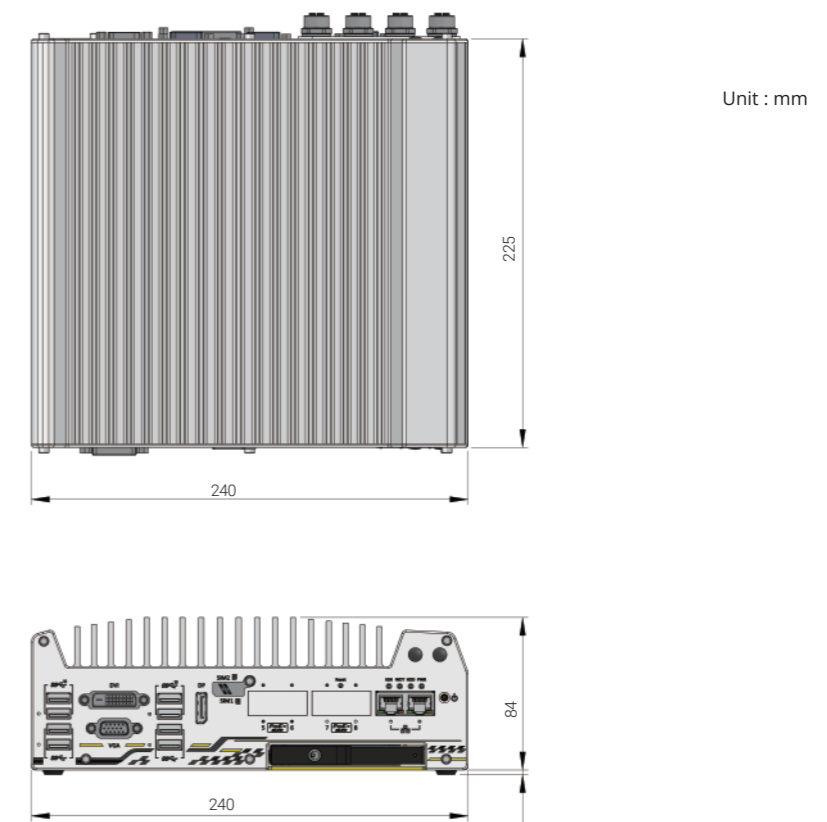

Ordering Information

Model No.	Product Description
Nuvo-7100VTC	Intel® 9th/ 8th-Gen Core™ in-vehicle controller with 4x M12 PoE+ Ports, DIO, CAN bus and RAID
Nuvo-7104VTC	Intel® 9th/ 8th-Gen Core™ in-vehicle controller with 4x RJ45 PoE+ Ports, DIO, CAN bus and RAID
Nuvo-7108VTC	Intel® 9th/ 8th-Gen Core™ in-vehicle controller with 8x RJ45 PoE+ Ports, DIO, CAN bus and RAID

Optional Accessories

Cbl-M12X8M-RJ45-500CM	M12 (8-pole-X-coded) to RJ45, CAT6, length : 500CM
Cbl-M12X8M-RJ45-1000CM	M12 (8-pole-X-coded) to RJ45, CAT6, length : 1000CM
PA-120W-OW	120W AC/DC power adapter 20V/6A; 18AWG/120cm; cord end terminals for terminal block, operating temperature : -30 to 70 °C.

Optional Cellular Module

NSIO-LTE-7455	Cat. 6 LTE embedded socket modem
----------------------	----------------------------------

Nuvo-5100VTC Series

Intel® 6th-Gen Core™ i7/i5/i3 In-vehicle Controller with 4x or 8x PoE+ Ports, DIO, CAN bus and RAID



CE FC E13 10R-0514321

Key Features

- Supports Intel® 6th-Gen Core™ i7/ i5/ i3 LGA1151 socket-type CPU
- 4x or 8x 802.3at Gigabit PoE+ ports via M12 or RJ45 connectors
- On-board CAN bus for in-vehicle communication
- 4-CH isolated DI and 4-CH isolated DO
- 2x SATA ports with one hot-swappable HDD tray, supporting RAID 0/ 1
- 4x full-size mini-PCIe sockets with SIM support
- 8 to 35V wide-range DC input with built-in ignition power control
- E-Mark and EN 50155/ EN 45545 certificate

Introduction

Nuvo-5100VTC is an in-vehicle controller in compliant with E-Mark and EN 50155/ EN 45545 certificate. Featuring Intel® 6th-Gen Core™ CPU, it exhibits superb CPU and GPU performance for various in-vehicle applications.

Nuvo-5100VTC offers four or eight 802.3at PoE+ ports to supply 25W power to the connected device. They are implemented using RJ45 or M12 (x-coded connectors), which guarantee extremely rugged connection in shock/ vibration environments. Two more Gigabit Ethernet ports by RJ45 are available for data communication. You can also utilize four internal mini-PCIe sockets with corresponding modules for 3G/ 4G/ WIFI/ GPS communication.

In addition, Nuvo-5100VTC integrates CAN bus for in-vehicle communication, and isolated DIO for sensor/ actuator control. Combining ignition power control and dual-drive RAID storage, Nuvo-5100VTC is the perfect solution for all your in-vehicle application needs.

Specifications

System Core		Storage Interface	
Processor	Supports Intel® 6th-Gen Core™ i7/ i5/ i3 LGA1151 CPU - Intel® Core™ i7-6700TE (8M Cache, 2.4/ 3.4 GHz, 35W TDP) - Intel® Core™ i5-6500TE (6M Cache, 2.3/ 3.3 GHz, 35W TDP) - Intel® Core™ i3-6100TE (4M Cache, 2.7 GHz, 35W TDP)	mSATA	1x full-size mSATA port (mux with mini-PCIe)
Chipset	Intel® Q170 platform controller hub	Expansion Bus	
Graphics	Integrated Intel® HD graphics 530	Mini PCI-E	1x full-size mini-PCIe socket with panel-accessible SIM socket 1x full-size mini-PCIe socket with internal SIM socket (mux. with mSATA) 2x full-size mini-PCIe sockets (USB signals only) with internal SIM sockets
Memory	Up to 32 GB DDR4-2133 SDRAM (two SODIMM slots)	Power Supply	
AMT	Supports AMT 11.0	DC Input	1x 3-pin pluggable terminal block for 8 to 35V DC input
TPM	Supports TPM 2.0	Remote Ctrl. & Status Output	1x 10-pin (2x5) wafer connector for remote on/ off control and status LED output
I/O Interface		Mechanical	
Ethernet	2x Gigabit Ethernet ports by Intel® I219 and I210	Dimension	240 mm (W) x 225 mm (D) x 79 mm (H)
PoE+	4x IEEE 802.3at (25.5W) Gigabit PoE+ ports by Intel® I210 - M12 x-coded connector (Nuvo-5100VTC); - RJ45 connector (Nuvo-5104VTC) 8x IEEE 802.3at (25.5W) Gigabit PoE+ ports by Intel® I210 - RJ45 connector (Nuvo-5108VTC)	Weight	3.3 kg
CAN	1x CAN 2.0 port	Mounting	Wall-mount with damping brackets (Standard) or DIN-rail mount (optional)
Isolated DIO	4x isolated DI and 4x isolated DO	Environmental	
USB 3.1	4x USB 3.1 ports via native xHCI controller	Operating Temperature	-40°C ~ 70°C */**
USB 2.0	4x USB 2.0 ports	Storage Temperature	-40°C ~ 85°C
Video Port	1x stacked VGA + DVI-D 2x DisplayPorts, supporting 4K2K resolution	Humidity	10%~90% , non-condensing
Serial Port	2x software-programmable RS-232/422/485 port (COM1 & COM3) 1x RS-232 port (COM2)	Vibration	IEC61373:2010, Category 1, Class B Body mounted (part of EN50155)
Audio	1x mic-in and 1x speaker-out	Shock	IEC61373:2010, Category 1, Class B Body mounted (part of EN50155)
Storage Interface		Certification	EN 50155/ EN45545 E-Mark (Nuvo-5108VTC) CE/ FCC Class A, according to EN 55022, EN 55024 & EN 55032
SATA HDD	1x hot-swappable HDD tray for 2.5" HDD/ SSD installation 1x Internal SATA port for 2.5" HDD/ SSD installation, supporting RAID 0/ 1		

* For i7-6700 running at 65W mode, the highest operating temperature shall be limited to 50°C and thermal throttling may occur when sustained full-loading applied. Users can configure CPU power in BIOS to obtain higher operating temperature.
** For sub-zero operating temperature, a wide temperature HDD drive or Solid State Disk (SSD) is required.

Appearance

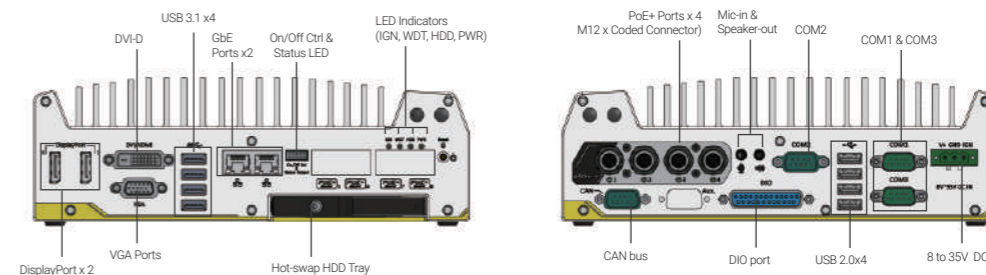

Dimensions

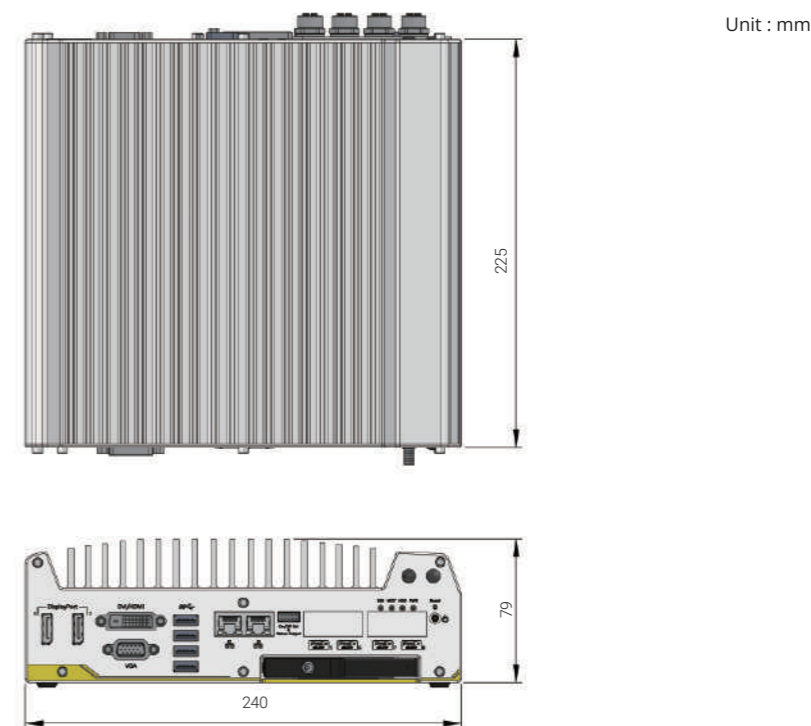

Ordering Information

Model No.	Product Description
Nuvo-5100VTC	Intel® 6th-Gen Core™ in-vehicle controller with 4x M12 PoE+ Ports, DIO, CAN bus and RAID
Nuvo-5104VTC	Intel® 6th-Gen Core™ in-vehicle controller with 4x RJ45 PoE+ Ports, DIO, CAN bus and RAID
Nuvo-5108VTC	Intel® 6th-Gen Core™ in-vehicle controller with 8x RJ45 PoE+ Ports, DIO, CAN bus and RAID

Optional Accessories

Cbl-M12X8M-RJ45-500CM	M12 (8-pole-X-coded) to RJ45, CAT6, length : 500CM
Cbl-M12X8M-RJ45-1000CM	M12 (8-pole-X-coded) to RJ45, CAT6, length : 1000CM
DINRAIL-O	DIN-rail mount assembly for Nuvo-5100VTC series
PA-120W-OW	120W AC/DC power adapter 20V/6A; 18AWG/120cm; cord end terminals for terminal block, operating temperature : -30 to 70 °C.

Nuvo-2610VTC Series

Intel® Elkhart Lake Atom® x6425E In-Vehicle Computer with 4x M12 PoE+ ports and 15mm 2.5" HDD/SSD support

Key Features

- Intel® Elkhart Lake Atom® x6425E quad-core 2.0GHz/ 3.0GHz 12W processor
- Rugged -40°C to 70°C fanless operation, compliant with EN 50155 Class OT4
- 4x PoE+ GbE ports via M12 x-coded connectors
- 1x front-accessible 2.5" 15mm HDD tray and 1x M.2 2280 SATA SSD
- 1x M.2 3042/3052 B Key for 4G/5G mobile broadband
- 2x full-size mini-PCIe sockets for WIFI/CAN/GNSS modules
- 8-35V wide-range DC input with built-in ignition power control



Introduction

The Nuvo-2610VTC series is a rugged Intel® Atom®-based in-vehicle computer that incorporates four M12 Gigabit PoE+ connectors and one front-accessible 2.5" HDD tray, supporting up to 15mm height HDD/SSD. It is designed to fulfill multi-purpose applications such as on-road, off-highway, or railway applications from mobile gateways, data loggers, to network video recorders (NVR).

Powered by Intel® Elkhart Lake Atom® x6425E quad-core CPU, the Nuvo-2610VTC series delivers 1.8x the CPU performance when compared with the previous generation, Nuvo-2510VTC. To provide robust Ethernet connectivity, the Nuvo-2610VTC series offers four Gigabit PoE+ ports via M12 x-coded connectors and one USB 3.1 with the screw-lock mechanism. In addition to the internal M.2 2280 SATA SSD for system storage, Nuvo-2610VTC also has one front-accessible 2.5" HDD tray accommodating a 2.5" SATA HDD/SSD with up to 15mm height and 5TB capacity. For internal expansion, it provides two mini-PCIe sockets for WiFi, GNSS, and CAN modules plus one M.2 3042/3052 B Key socket for 4G/5G mobile broadband module.

To meet versatile in-vehicle deployment conditions, the Nuvo-2610VTC series comes in three variants. In addition to Nuvo-2610VTC, the Nuvo-2611VTC is equipped with an embedded SuperCAP UPS to withstand power interruptions or voltage fluctuations on the train and can sustain the system for a proper shutdown when the power is cut-off. The Nuvo-2612VTC has a Cassette module for an additional Gen3 x2 PCIe slot that can accommodate an AI accelerator module with a tailor-made thermal solution. With the AI accelerator, it becomes a fanless GPU computer for intelligent video analytics or a data logger with perception capability.

By integrating an Intel Atom® quad-core x6425E, -40°C to 70°C fanless operations, wide-range DC input with ignition control, and 4G LTE / 5G NR mobile broadband connectivity, the Nuvo-2610VTC series is an ideal rugged, multi-purpose, in-vehicle computer for aftermarket on-road in-vehicle applications. With rugged M12 PoE+ connectivity and built-in SuperCAP UPS, the Nuvo-2610VTC series can withstand harsh and unstable electrical environments for off-highway applications such as trucks, cargo vehicles, and rolling stock.

Specifications

System Core		Power Supply	
Processor	Intel® Elkhart Lake Atom® x6425E quad-core 2.0GHz/3.0GHz 12W processor	DC Input	1x 3-pin pluggable terminal block for 8V to 35V DC input with built-in ignition power control (IGN/GND/V+)
Graphics	Integrated Intel® UHD Graphics	Remote Ctrl. & LED Output	1x 3-pin pluggable terminal block for remote control and PWR LED output
Memory	Up to 32 GB DDR4-3200 SDRAM by one SODIMM socket	Power Backup	
Panel I/O Interface		Capacity	2500 watt-second (Nuvo-2611VTC only)
PoE	4x IEEE 802.3at (25.5W) Gigabit PoE+ ports by Intel® I210 via M12 x-coded connectors	Mechanical	
Video Port	VGA and DVI dual display outputs via DVI-I connector	Dimension	205 mm (W) x 155 mm (D) x 58 mm (H) (Nuvo-2610VTC) 205 mm (W) x 155 mm (D) x 86 mm (H) (Nuvo-2611VTC, Nuvo-2612VTC)
USB 3.1	1x USB 3.1 gen1 ports with screw-lock	Weight	1.9 kg (Nuvo-2610VTC) 2.5 kg (Nuvo-2611VTC) / 2.3 kg (Nuvo-2612VTC)
USB 2.0	2x USB 2.0 port with screw-lock	Mounting	Damping bracket (default) Wall-mount (optional)
Serial Port	1x isolated RS-485 port with 15 kV ESD protection (COM1) 3x 3-wire RS-232 ports (COM2/3/4) or 1x RS-422/485 (COM2)	Environmental	
Audio	1x 3.5 mm jack for mic-in and speaker-out	Operating Temperature	-40°C ~ 70°C*
Isolated DIO	4-CH isolated DI and 4-CH isolated DO	Storage Temperature	-40°C ~ 85°C
Expansion Bus		Humidity	10%~90% , non-condensing
PCI Express	1x PCIe x4 slot @Gen3, 2-lane PCIe signal in Cassette (Nuvo-2612VTC only)	Vibration	Operating, MIL-STD-810G, Method 514.7, Category 4 IEC61373:2010, Category 1, Class B Body Mounted (part of EN50155)
Mini-PCIe	1x full-size mini PCI Express socket with PCIe and USB 2.0 signal 1x full-size mini PCI Express socket with USB 2.0 signal	Shock	Operating, MIL-STD-810G, Method 516.7, Procedure I IEC61373:2010, Category 1, Class B Body Mounted (part of EN50155)
M.2 B key	1x M.2 3042/3052 B key (USB 3.1 + USB 2.0) for 4G/5G module with dual internal micro SIM socket	EMC	EN 50155:2017, Clause 13.4.8 CE/FCC Class A, according to EN 55032 & EN 55035
Storage Interface		** For sub-zero operating temperature, a wide temperature HDD drive or Solid State Disk (SSD) is required.	
M.2 SATA	1x M.2 2280 M key (SATA interface only) socket for SATA SSD installation		
SATA HDD	1x front-accessible HDD tray for 2.5" HDD/SSD installation (up to 15mm height)		

Appearance

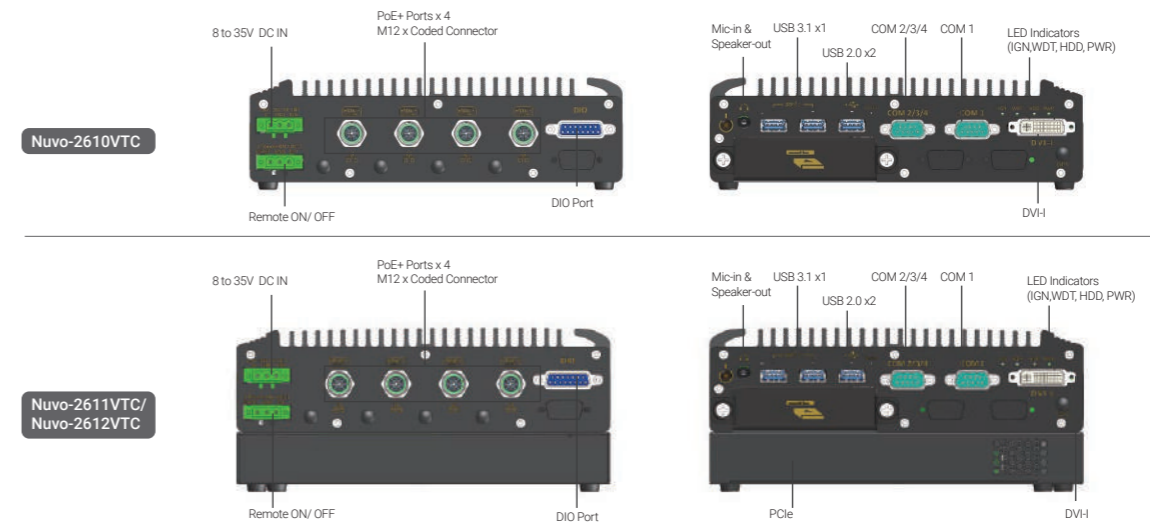

Dimensions

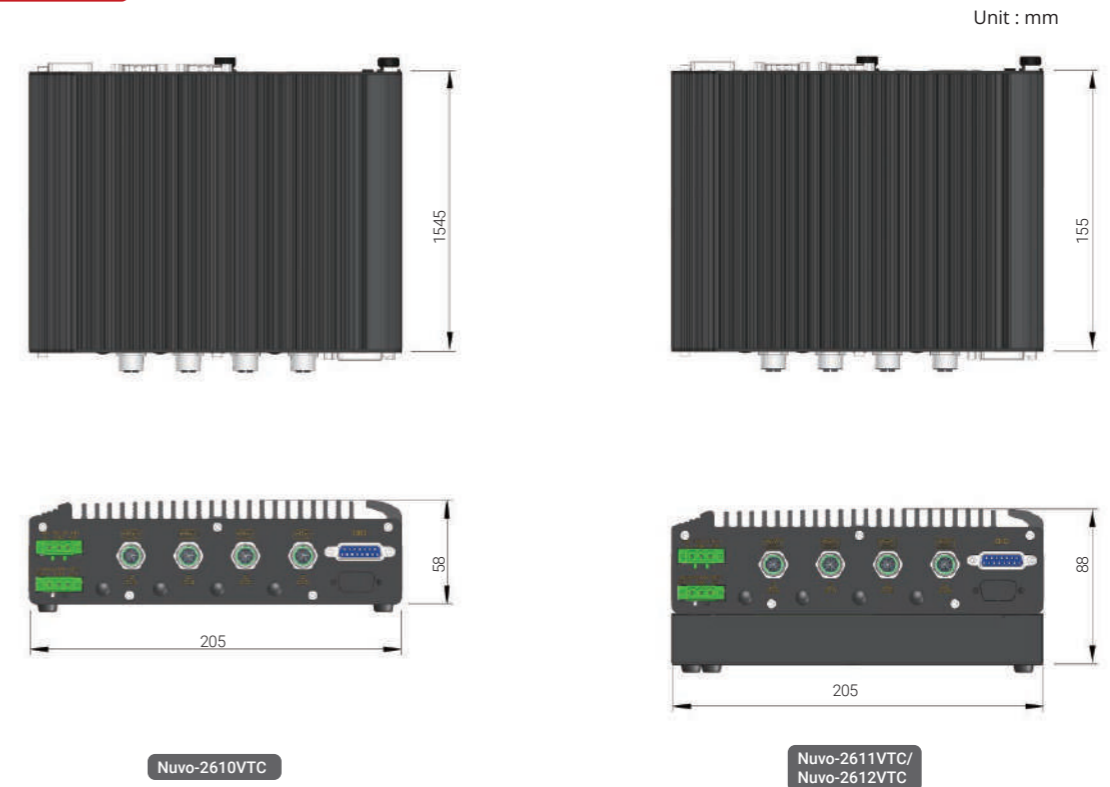

Ordering Information

Model No.	Product Description
Nuvo-2610VTC	Intel® Elkhart Lake Atom® x6425E in-vehicle fanless computer with M12 PoE+ and 15mm 2.5" HDD/SSD support
Nuvo-2611VTC	Intel® Elkhart Lake Atom® x6425E in-vehicle fanless computer with M12 PoE+, 15mm 2.5" HDD and built-in SuperCAP UPS
Nuvo-2612VTC	Intel® Elkhart Lake Atom® x6425E in-vehicle fanless computer with M12 PoE+, 15mm 2.5" HDD and single-slot PCIe Cassette

Optional Accessories

PA-120W-OW	120W AC/DC power adapter 20V/6A; 18AWG/120cm; cord end terminals for terminal block, operating temperature: -30 to 70°C.
PA-160W-OW	160W AC-DC power adapter 20V/8A; 18AWG/120cm; cord end terminals for terminal block, operating temperature: -30 to 70°C.
Wmkit-Nuvo-2600	Wall mounting kit for Nuvo-2600 and Nuvo-2610VTC series, including wall mounting brackets and screws

Nuvo-2615RL Series

EN50155 & EN45545 Intel® Elkhart Lake Atom® x6425E Railway Computer Supporting 110 VDC Input and 4x M12 PoE+

Key Features

- Compliant with EN 50155 mandatory tests and EN 45545-2
- Rugged -40°C to 70°C fanless operations, compliant with EN 50155 Class OT4
- 43V to 160V isolated wide-range DC input
- Intel® Elkhart Lake Atom® x6425E quad-core 2.0GHz/ 3.0GHz 12W processor
- 4x PoE+ GbE ports via M12 x-coded connectors
- Built-in SuperCAP UPS for power interruptions > 30 seconds
- 1x front-accessible 2.5" 15mm HDD tray and 1x M.2 2280 SATA SSD
- 2x full-size mini-PCIe sockets and 1x M.2 3042/3052 B Key



Preliminary

Introduction

The Nuvo-2615RL series is an EN50155 and EN45545-compliant, fanless Intel® Atom®-based railway computer for video-based rolling stock applications such as NVR (network video recorder) and video analytics.

Nuvo-2615RL has a dedicated thermal design to meet EN50155 OT4 class (-40°C to 70°C) fanless operation with max CPU performance and up to 50W PoE+ delivery. To overcome the challenging railway conditions, from voltage fluctuations to power outage interruptions, Nuvo-2615RL is equipped with an isolated wide 43V to 160V DC input design and a built-in SuperCAP UPS to sustain more than 30 seconds of operation time without power supply. If power outage time exceed the sustainable duration, the internal microcontroller (MCU) will trigger a software shutdown before running out of SuperCAP energy to protect the hardware, data, and minimize maintenance costs.

Powered by Intel® Elkhart Lake Atom® x6425E quad-core CPU, the Nuvo-2615RL series delivers 1.8x the CPU performance compared with Intel's previous Atom generation, Apollo Lake. The Nuvo-2615RL series features 4x PoE+ GbE ports with up to 50W total power budget for IP camera connectivity. In addition to the internal M.2 2280 SATA SSD for system storage, Nuvo-2615RL has one front-accessible 2.5" HDD tray accommodating a 2.5" SATA HDD/SSD up to 15mm in height and 5TB in capacity. For internal expansion, it provides two mini-PCIe sockets for WiFi, GNSS, and CAN modules. There is also an M.2 3042/3052 B Key socket for 4G/5G mobile broadband modules.

Integrating an Intel Atom® quad-core x6425E, -40°C to 70°C fanless operations, M12 PoE+ connectivity, up to 5TB data storage capacity, 2500 watt-second SuperCAP UPS, 43V to 160V wide-range DC input, and EN50155 and EN45545 compliance, the Nuvo-2615RL series is the ideal rugged transportation computer for vision-based rolling stock applications.

Specifications

System Core		Power Supply	
Processor	Intel® Elkhart Lake Atom® x6425E quad-core 2.0GHz/ 3.0GHz 12W processor	DC Input	1x 3-pin pluggable terminal block for isolated 43V to 160V DC input
Graphics	Integrated Intel® UHD Graphics	Power Backup	
Memory	Up to 32 GB DDR4-3200 SDRAM by one SODIMM socket	Capacity	2500 watt-second
Panel I/O Interface		Mechanical	
Power over Ethernet	4x IEEE 802.3at Gigabit PoE+ ports by Intel® I210 via M12 x-coded connectors Total PoE+ power budget: 50W (Nuvo-2615RL-H)	Dimension	205 mm (W) x 156 mm (D) x 86 mm (H)
Video Port	VGA and DVI dual display outputs via DVI-I connector	Weight	2.7 kg
USB 3.1	1x USB 3.1 Gen1 ports with screw-lock	Mounting	Damping Bracket (standard) Wall-mount (optional)
USB 2.0	2x USB 2.0 port with screw-lock	Environmental	
Serial Port	1x isolated RS-485 port with 15 kV ESD protection (COM1) 3x 3-wire RS-232 ports (COM2/3/4) or 1x RS-422/485 (COM2)	Operating Temperature	-40°C to 70°C*, compliant with EN50155 Class OT4
Isolated DIO	4-CH isolated DI and 4-CH isolated DO	Storage Temperature	-40°C ~85°C
Audio	1x 3.5 mm jack for mic-in and speaker-out	Humidity	10%~90% , non-condensing
Expansion Bus		Vibration	IEC61373:2010, Category 1, Class B Body Mounted (part of EN 50155) (pending)
Mini-PCIe Express	1x full-size mini PCI Express socket with PCIe and USB 2.0 signal 1x full-size mini PCI Express socket with USB 2.0 signal	Shock	IEC61373:2010, Category 1, Class B Body Mounted (part of EN 50155) (pending)
M.2 B key	1x M.2 3042/3052 B key (USB 3.1 + USB 2.0) for 4G/5G module with dual internal micro SIM socket	EMC	EN 50155:2017, Clause 13.4.8 CE/FCC Class A, according to EN 55032 & EN 55035
Storage Interface		EN50155	All mandatory sections of EN 50155:2017 Exceeds EN 50155 Class S3 (30 sec holdup time by internal SuperCAP UPS)
M.2 SATA	1x M.2 2280 M key (SATA interface only) socket for SATA SSD installation	EN45545	EN 45545-2 (Fire protection on railway vehicles)
SATA HDD	1x front-accessible HDD tray for 2.5" HDD/ SSD installation (up to 15mm height)	** For sub-zero operating temperature, a wide temperature HDD drive or Solid State Disk (SSD) is required.	

Appearance

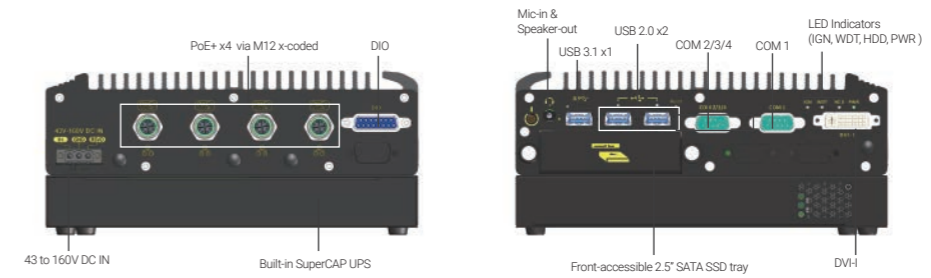

Dimensions

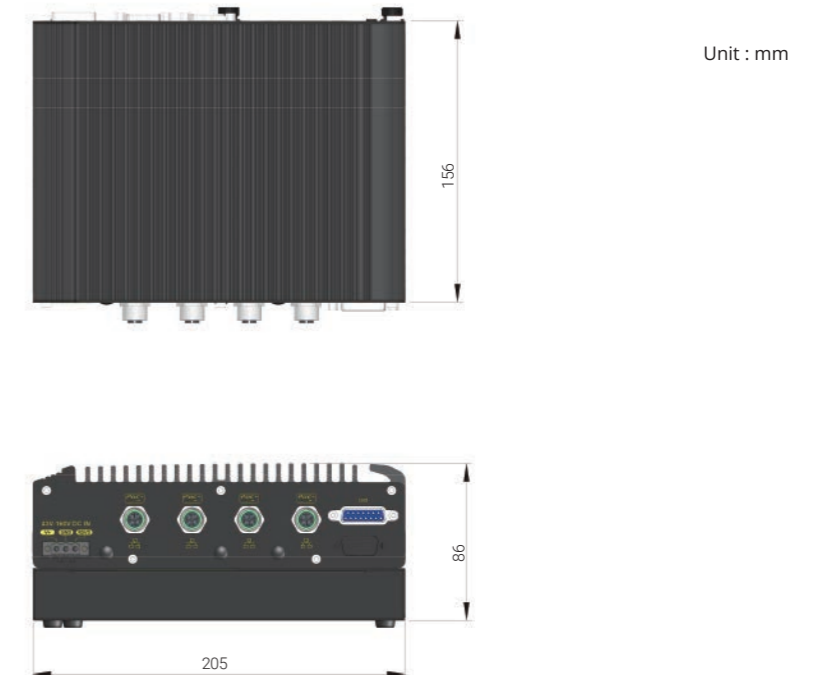

Ordering Information

Model No.	Product Description
Nuvo-2615RL-H	EN50155 & EN45545 Intel® Elkhart Lake Atom® x6425E Railway Fanless Computer with 4x M12 PoE+ and 43V to 160V ultra-wide-range DC input

POC-551VTC

AMD Ryzen™ V1000 Ultra-compact In-vehicle Controller with PoE+, DIO and Isolated CAN bus



Key Features

- AMD Ryzen™ embedded V1000 series quad-core 15W CPU
- -40°C to 70°C rugged wide temperature fanless operation
- Four IEEE 802.3at PoE+ ports with screw-lock
- One isolated CAN bus port for in-vehicle communication
- One M.2 socket and three mPCIe sockets
- M.2 2280 M key NVMe (Gen3 x2) socket for fast storage access
- 4-CH isolated DI and 4-CH isolated DO
- 8 to 35V DC input with built-in ignition power control
- E-Mark and EN 50155/ EN 45545 certificate

Introduction

POC-551VTC is the next generation ultra-compact, fanless in-vehicle controller offering performances never-seen-before in this form factor. Featuring AMD Ryzen™ Embedded V1000 4-core/ 8-thread processor, POC-551VTC delivers up to 3x times the CPU performance compared to previous generation, POC-351VTC. It combines finesse performance, extraordinary reliability and affordability for versatile in-vehicle applications.

POC-551VTC offers four 802.3at PoE+ ports to supply 25W power to device such as IP cameras. As wireless connectivity is essential for modern in-vehicle application, POC-551VTC with built-in one M.2 and three mini-PCIe are more applicable for in-vehicle use nowadays. It also integrates CAN bus for in-vehicle communication, and isolated DIO for sensor/ actuator control.

Combining ignition power control and wide-range DC input along with superior performance, POC-551VTC is the perfect solution for all your in-vehicle application needs in an extremely compact size!

Specifications

System Core		Power Supply	
Processor	AMD Ryzen™ V1605B CPU (4C/ 8T, 2M Cache, 2.0/ 3.6 GHz, 12W - 25W TDP)	DC Input	1x 3-pin pluggable terminal block for 8V to 35V DC input with built-in ignition power control (IGN/GND/V+)
Graphics	Vega GPU with 6 compute units	Remote Ctrl.&LED Output	1x3-pin pluggable terminal block for remote control and PWR LED output
Memory	Up to 16 GB DDR4-2400 SDRAM by one SODIMM sockets	Mechanical	
TPM	Supports TPM 2.0	Dimension	64 mm (W) x 116 mm (D) x 176 mm (H)
Panel I/O Interface		Weight	1.3 kg
Ethernet port	4x Gigabit Ethernet ports by Intel® I350-AM4 controller	Mounting	Wall-mount (standard) or DIN-rail mount (optional)
PoE+	4xIEEE 802.3at Gigabit PoE+ ports by Intel® I350-AM4	Environmental	
CAN	1x CAN 2.0 port	Operating Temperature	-40°C ~ 70°C*/**/**
Isolated DIO	4x Isolated DI and 4x Isolated DO	Storage Temperature	-40°C ~ 85°C
USB 3.1	4x USB 3.1 Gen1 ports with screw-lock	Humidity	10%~90% , non-condensing
Video Port	1x VGA, supporting 1920 x 1200 resolution 1x DisplayPort, supporting 4096 x 2160 resolution	Vibration	IEC61373:2010, Category 1, Class B Body mounted (part of EN50155)
Serial Port	1x software-programmable RS-232/ 422/ 485 ports (COM1) 3x 3-wire RS-232 ports (COM2/ 3/ 4) or 1x RS-422/ 485 port (COM2)	Shock	IEC61373:2010, Category 1, Class B Body mounted (part of EN50155)
Audio	1x 3.5 mm jack for mic-in and speaker-out	EMC	EN 50155, EN45545, E-Mark for in-vehicle applications CE/FCC Class A, according to EN 55032 & EN 55024
Storage Interface		* For wide temperature use condition, a wide temperature/industrial mSATA module is required. ** For full function use condition (mini-PCIe, M.2, and mSATA are all adopted), the recommended operating temperature is -25°C ~ 60°C *** For extreme wide temperature -40°C ~ 70°C, it is optional with 100% screening, please contact Neousys Technology	
M.2	1x M.2 2280 M key NVMe socket (PCIe Gen3/ x2) installation		
mSATA	1x full-size mSATA port		
Expansion Bus			
Mini PCIe	3x full-size mini PCI Express socket with internal SIM socket		
M.2	1x M.2 2242 B key socket for 3G/ 4G option with USIM support		

Appearance

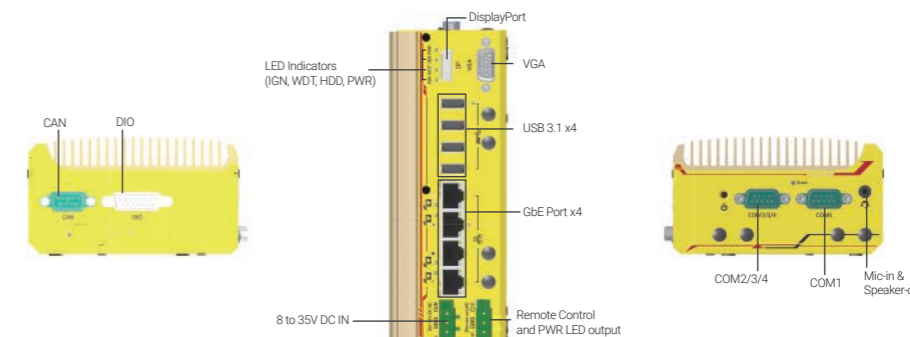

Dimensions

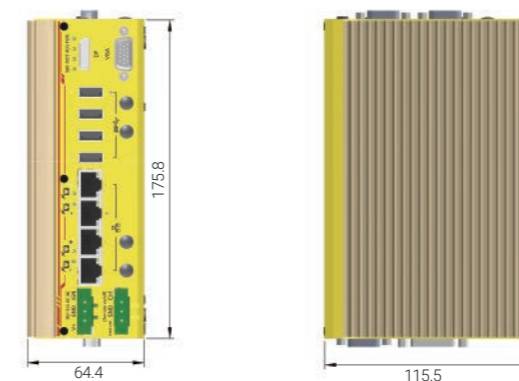

Unit : mm

Ordering Information

Model No.	Product Description
POC-551VTC	AMD Ryzen™ V1605B ultra-compact In-vehicle controller with PoE+, DIO and isolated CAN bus

Optional Accessories

PA-120W-OW	120W AC/DC power adapter 20W/6A; 18AWG/120cm; cord end terminals for terminal block, operating temperature : -30 to 70 °C.
PA-60W-OW	60W AC/DC power adapter with 12V, 5A DC output, cord end terminals for terminal block. operating temperature : -30 to 60 °C.

Optional Cellular Module

NSIO-LTE-7455	Cat. 6 LTE embedded socket modem
---------------	----------------------------------

POC-451VTC Series

Intel® Elkhart Lake Atom® x6425E Ultra-compact In-vehicle Computer with 3x 2.5G, PoE+ and M.2/mPCIe for WIFI/4G/5G Modules

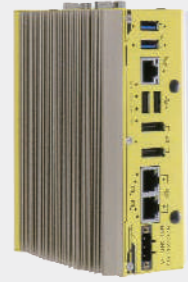

Key Features

- Intel® Atom® x6425E quad-core processor
- Rugged -25°C to 70°C fanless operation
- 2x 2.5GbE PoE+ ports and 1x 2.5GbE port
- 1x M.2 2242/ 3052 B key for 4G/5G module
- 2x M.2 2230 E key for WIFI and edge TPU module
- Conduction-cooled heatsink for M.2/ mPCIe modules
- Dual M.2 2280 M key for SATA SSD
- 8~35V DC input with built-in ignition power control



Introduction

POC-451VTC is an ultra-compact in-vehicle computer with E-Mark certificate for in-vehicle applications, such as mobile gateway, mobile surveillance and passenger information system. It leverages the latest Intel® Elkhart Lake Atom® x6425E CPU, delivering 1.8x and 2x performance improvement for the CPU and GPU respectively, compared to the previous generation, POC-351VTC.

POC-451VTC provides multiple M.2 and mPCIe slots for installation of 4G/5G, WIFI5/6, CAN bus and edge TPU module for modern in-vehicle applications. It can therefore extend WIFI and broadband wireless communication as well as AI inference functionality inside a compact footprint. More than that, POC-451VTC introduces a dedicated conduction-cooled heat spreader to bring out and dissipate heat generated by M.2/mPCIe modules to maintains optimal system performance at high temperature environment.

POC-451VTC further offers three 2.5GBASE-T Ethernet ports with PoE+ capability for powering PoE PD devices, such as IP camera and GigE camera. They are backward-compatible with 1000/100 Mbps Ethernet to work with most existing Ethernet devices. It also provides isolated DIO for sensor/ actuator control and 8V-35V wide range DC input with ignition power control for in-vehicle deployment.

Combining significant performance boost, 2.5G PoE+ ports, superior thermal reliability for communication and inference, POC-451VTC is a AI-capable, mobile gateway solution to explore more possibility of versatile in-vehicle applications.

Specifications

System Core		Power Supply	
Processor	Intel® Elkhart Lake Atom® x6425E quad-core 2.0GHz/3.0GHz 12W processor	DC Input	1x 3-pin pluggable terminal block for 8V to 35V DC input with built-in ignition power control (IGN/GND/V+)
Graphics	Integrated Intel® UHD Graphics	Mechanical	
Memory	Up to 32 GB DDR4-3200 SDRAM by one SODIMM socket	Dimension	153 mm (W) x 108 mm (D) x 72 mm (H)
TPM	Supports fTPM 2.0	Weight	1.4 kg
Panel I/O Interface		Mounting	Vertical-type wall-mount (standard) DIN-rail mount (optional)
Ethernet	3x 2.5GBASE-T Ethernet ports by Intel® I225 GbE controllers	Storage Interface	
PoE	IEEE 802.3at PoE+ on port #2 and #3	M.2 M key	2x M.2 2280 M key sockets for SATA SSD
Video Port	2x DisplayPort connector, supporting 4096 x 2160 resolution @ 60Hz	Environmental	
USB 3.1	2x USB 3.1 Gen1 (5 Gbps) ports	Operating Temperature	-25°C ~ 70°C*/**
USB 2.0	2x USB 2.0 ports	Storage Temperature	-40°C ~ 85°C
Serial Port	1x software-programmable RS-232/422/485 ports (COM1) 3x 3-wire RS-232 ports (COM2/3/4) or 1x RS-422/485 port (COM2)	Humidity	10%~90% , non-condensing
Audio	Optional 1x 3.5 mm jack for mic-in and speaker-out	Vibration	Operating, MIL-STD-810G, Method 514.6, Category 4
Isolated DIO	4x isolated DI and 4x isolated DO	Shock	Operating, MIL-STD-810G, Method 516.6, Procedure I, Table 516.6-II
Internal Expansion Bus		EMC	E-Mark CE/FCC Class A, according to EN 55032 & EN 55035
M.2 E key	2x M.2 2230 E key socket for WIFI or Google edge TPU	* For wide temperature use condition, a wide temperature/industrial M.2 M key SATA SSD module is required. ** For full function use condition (mini-PCIe and M.2 are all adopted), the operating temperature may be constrained by mini-PCIe and M.2 modules. Please contact Neousys Technology.	
M.2 B key	1x M.2 2242/ 3052 B key socket for 4G/5G module with dual SIM support		
Mini-PCIe	1x full-size mini-PCIe socket (USB2 signal only)		

Appearance

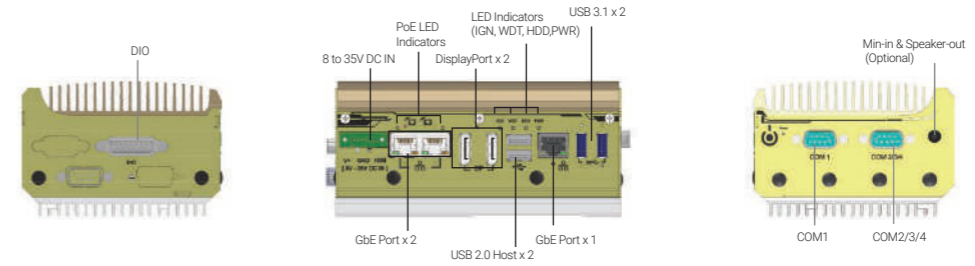

Dimensions

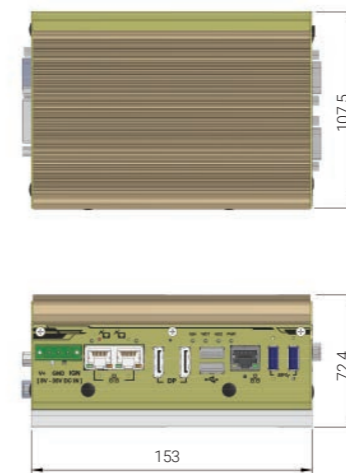

Unit : mm

Ordering Information

Model No.	Product Description
POC-451VTC	Intel® Elkhart Lake Atom® x6425E ultra-compact in-vehicle computer with 3x 2.5G, PoE+ and M.2/mPCIe for WIFI/4G/5G modules

Optional Accessories

PA-60W-OW	60W AC/DC power adapter with 12V, 5A DC output, cord end terminals for terminal block. Operating temperature : -30 to 60 °C
PA-120W-OW	120W AC/DC power adapter 20V/6A; 18AWG/120cm; cord end terminals for terminal block, operating temperature : -30 to 70 °C
Cbl-DB9F-3DB9M-15CM	1x DB9 (Female) to 3x DB9 (Male), length: 15CM

POC-351VTC Series

Intel® Apollo Lake Atom™ E3950 Ultra-compact In-vehicle Controller with GbE, PoE+ and Isolated CAN bus

Key Features

- Intel® Apollo Lake Atom™ E3950 quad-core processor
- Rugged, -25 °C to 70 °C fanless operation
- Two IEEE 802.3at PoE+ ports and one GbE port
- One isolated CAN bus port for in-vehicle communication
- One M.2 socket and three mPCIe sockets
- Aluminum heat-spreader for M.2/ mPCIe modules
- 4-CH isolated DI and 4-CH isolated DO
- 8 to 35V DC input with built-in ignition power control



Introduction

POC-351VTC is an ultra-compact, fanless in-vehicle controller powered by Intel® Apollo Lake Atom™ E3950 quad-core processor. It combines finesse performance, extraordinary reliability and affordability for versatile in-vehicle applications.

POC-351VTC offers two PoE+ ports to power devices such as IP cameras, and one additional GbE port for data communication. It also features isolated CAN bus 2.0 port and RS-232/ 422/ 485 ports for communicating with other automotive devices. Wide-range DC input and ignition power control make POC-351VTC fit for various vehicle types.

Wireless and internet access is essential for modern day in-vehicle applications and POC-351VTC has a total of four M.2/ mPCIe sockets and six antenna holes to accommodate a variety of 4G, 3G, WIFI and GPS modules. An aluminum heat-spreader is thoughtfully designed to dissipate the heat generated by modules to maintain superior operating stability, for the system and communication modules.

Specifications

System Core		Power Supply	
Processor	Intel® Atom™ E3950 1.6/ 2.0 GHz quad-core processor	DC Input	1x 3-pin pluggable terminal block for 8V to 35V DC input with built-in ignition power control (IGN/GND/V+)
Graphics	Integrated Intel® HD graphics 505	Input Connector	3-pin pluggable terminal block for DC input (IGN/ GND/ V+)
Memory	Up to 8GB DDR3L-1866 (single SODIMM slot)	Mechanical	
Panel I/O Interface		Dimension	153 mm (W) x 108 mm (D) x 56 mm (H) (POC-351VTC) 153 mm (W) x 108 mm (D) x 68 mm (H) (POC-351VTC-70)
Ethernet	3x Gigabit Ethernet ports by Intel® I210 GbE controller	Weight	1.0 kg (POC-351VTC) 1.1 kg (POC-351VTC-70)
PoE	IEEE 802.3at PoE+ on port #2 and #3	Mounting	Horizontal Wall-mount (standard) or Vertical Wall-mount (optional)
Video Port	VGA and DVI dual display outputs via DVI-I	Environmental	
USB 3.1	2x USB 3.1 ports	Operating Temperature	-25°C ~ 70°C */** -40°C ~ 70°C (optional) */***
USB 2.0	2x USB 2.0 ports	Storage Temperature	-40°C ~ 85°C**
Serial Port	• 1x software-programmable RS-232/ 422/ 485 ports (COM1) • 3x 3-wire RS-232 ports (COM2/ COM3/ COM4) • 1x RS-422/485 port (COM2)	Humidity	10%~90% , non-condensing
Audio	1x mic-in and 1x speaker-out	Vibration	Operating, 5 Grms, 5-500 Hz, 3 Axes (w/ mSATA, according to IEC60068-2-64)
CAN bus	1x isolated CAN 2.0 port	Shock	Operating, 50 Grms, Half-sine 11 ms Duration (w/ mSATA, according to IEC60068-2-27)
Isolated DIO	4x isolated DI and 4x isolated DO	EMC	E-Mark for in-vehicle applications CE/ FCC Class A, according to EN 55032 & EN 55024
Internal I/O Interface		* For wide temperature use condition, a wide temperature/industrial mSATA module is required. ** For full function use condition (mini-PCIe, M.2, and mSATA are all adopted), the recommended operating temperature is -25°C ~ 60°C *** For extreme wide temperature -40°C ~ 70°C, it is optional with 100% screening, please contact Neousys Technology	
M.2	1x M.2 B key socket for 3G/ 4G option with USIM support		
Mini-PCIe	3x full-size mini PCI Express sockets with USIM support		
Storage Interface			
mSATA	1x half-size mSATA port 1x full-size mSATA port		

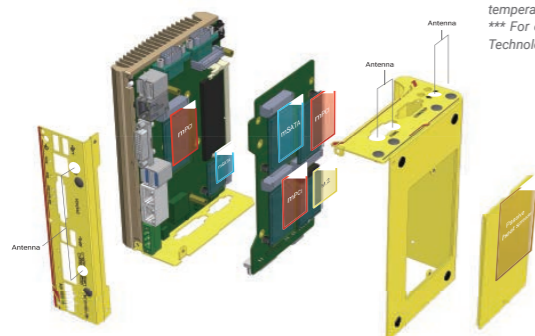

- mPCI x3
- mSATA x2
- M.2 x1
- Antenna x6
- Passive heat spreader for M.2 and mPCIe modules

Appearance

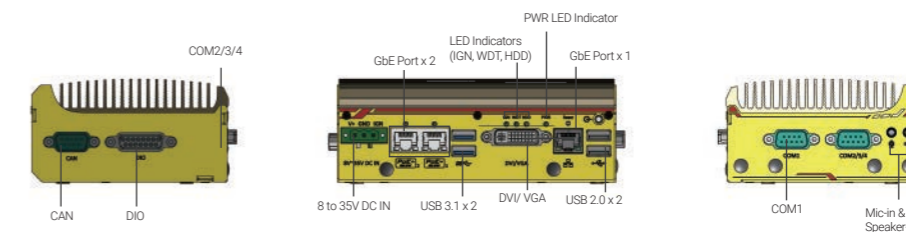

Dimensions

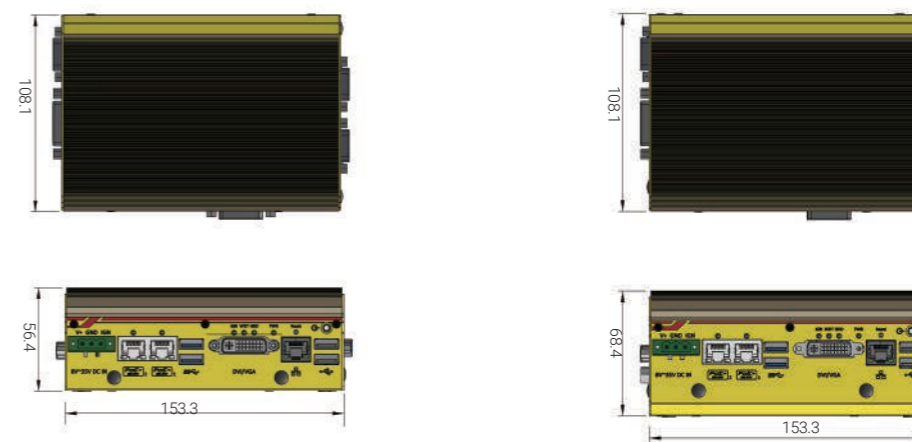

Unit : mm

POC-351VTC

POC-351VTC-70

Ordering Information

Model No.	Product Description
POC-351VTC	Intel® Apollo Lake Atom™ E3950 ultra-compact in-vehicle controller with 1x GbE, 2x PoE+ and isolated CAN
POC-351VTC-70	Intel® Apollo Lake Atom™ E3950 ultra-compact in-vehicle controller supporting optional LTE socket modem

Optional Accessories

Wmkit-V-POC300	Wall-mount assembly for POC-351VTC, vertical type
PA-60W-OW	60W AC/DC power adapter with 12V, 5A DC output, cord end terminals for terminal block. operating temperature : -30 to 60 °C.

Optional Cellular Module

NSIO-LTE-7455	Cat. 6 LTE embedded socket modem
---------------	----------------------------------

NRU-110V Series

NVIDIA® Jetson AGX Xavier™ Edge AI Platform Supporting 8x GMSL Automotive Cameras and 10GbE Ethernet



Key Features

- Powered by NVIDIA® Jetson AGX Xavier™ SOM bundled with JetPack 4.4
- Support 8x GMSL automotive cameras via FAKRA Z connectors
- 1x 10GBASE-T 10G Ethernet port
- 1x M.2 2280 M key socket for NVMe SSD
- 1x mini PCIe socket for WiFi/4G module
- 1x isolated CAN bus port and 1x RS232 port with flow control
- 1x GPS PPS input, 3-CH isolated DI and 4-CH isolated DO
- 8V to 35V wide-range DC input with built-in ignition power control



Introduction

The NRU-110V series is a Jetson AGX Xavier™ computer supporting GMSL cameras that can act as a camera sensor hub for autonomous driving, a control unit for autonomous mobile robots (AMR), or a video transcoding unit for teleoperation of unmanned ground vehicles. It is a turnkey solution with on-board GMSL deserializers for eight synchronized automotive GMSL camera inputs and a pre-installed board support package (BSP) with drivers for selected cameras.

The support of GMSL cameras equips NRU-110V with powerful vision capability. Taking advantage of automotive cameras featuring IP67 waterproof characteristic, high dynamic range (>120dB HDR), auto white balance (AWB), and LED flickering mitigation (LFM), NRU-110V can obtain high-quality images regardless of lighting conditions, from bright sunny days to overcast weather and pitch-black nights. More than that, it not only has a unique synchronization mechanism capable of simultaneously acquiring images from eight GMSL cameras within microseconds channel-to-channel skew, but also accepts GPS PPS signal to align image data with other sensors, such as LIDAR or cameras on other systems.

NRU-110V further integrates various I/O interfaces to interact with different sensors on autonomous machines. It has a 10Gb Ethernet to stream raw images in real-time to another powerful GPU computer performing perception, a CAN bus interface for in-vehicle communication, or connect an inertial measurement unit (IMU) to localize and determine orientation and position. Additionally, NRU-110V offers RS-232 plus dedicated GPS PPS input for connecting an external GPS module, M.2 NVMe slot for storage extension, mini-PCIe for WiFi/ 4G module connectivity, and isolated DIO for generic controls.

Combining eight GMSL automotive camera support, significant TFLOPS inference performance, multiple sensor interfaces, and 10GbE data transmission, the NRU-110V is a rugged edge AI computer connected to a variety of sensors to fulfill perception and planning on the same platform. It is ideal for AI-based vision applications that require continuous interactions with surroundings, such as UGV, AMR, ADAS, intelligent V2X, etc.

Specifications

System Core		Power Supply	
Processor	Supporting NVIDIA® Jetson AGX Xavier™ system-on-module, comprising of NVIDIA® Volta GPU and Carmel CPU	DC Input	1x 3-pin pluggable terminal block for 8V to 35V DC input (IGN/ GND/ V+)
Memory	32GB LPDDR4x @ 2133 MHz on SOM	Mechanical	
eMMC	32GB eMMC 5.1 on SOM	Dimension	230 mm (W) x 173 mm (D) x 66 mm (H)
I/O Interface		Weight	2.7 kg (excluding damping bracket)
GMSL Camera	8x GMSL FAKRA Z connector, supporting 8x 1280x720 @ 30 FPS camera input	Mounting	Neosys' patented damping bracket (standard)
Ethernet port	1x 10GBASE-T 10G Ethernet port by Intel® X550-AT controller	Environmental	
CAN bus	1x isolated CAN bus 2.0 port	Operating Temperature	-25°C ~ 50°C with passive cooling (MAX TDP mode) * -25°C ~ 70°C with passive cooling (30W TDP mode) * -25°C ~ 70°C with optional fan kit (all modes) *
Isolated DIO	1x GPS PPS input, 3-CH isolated DI and 4-CH isolated DO	Storage Temperature	-40°C ~ 85°C
USB	3x USB 3.1 Gen1 (5 Gbps) ports	Humidity	10% ~ 90%, non-condensing
Video Port	2x DisplayPort, supporting 3840x2160 at 60Hz	Vibration	Operating, MIL-STD-810G, Method 514.7, Category 4
Serial Port	1x RS-232 port with flow control	Shock	Operating, MIL-STD-810G, Method 516.7, Procedure 1
Storage Interface		EMC	CE/ FCC Class A, according to EN 55032 & EN 55035
M.2 NVMe	1x M.2 2280 M key socket (PCIe Gen3 x2) for NVMe SSD	<small>Note: * For sub-zero and over 60°C operating temperature, a wide temperature Solid State Disk (SSD) is required. NRU-110V is shipped with 30W TDP mode.</small>	
Internal Expansion Bus			
Mini PCI Express	1x full-size mini PCI Express socket with internal SIM socket		

Appearance

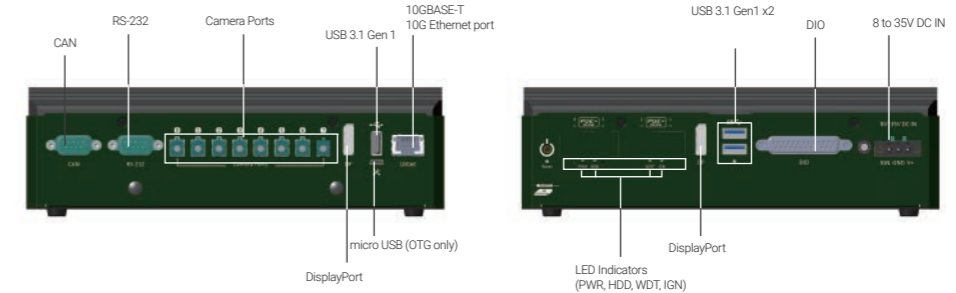

Dimensions

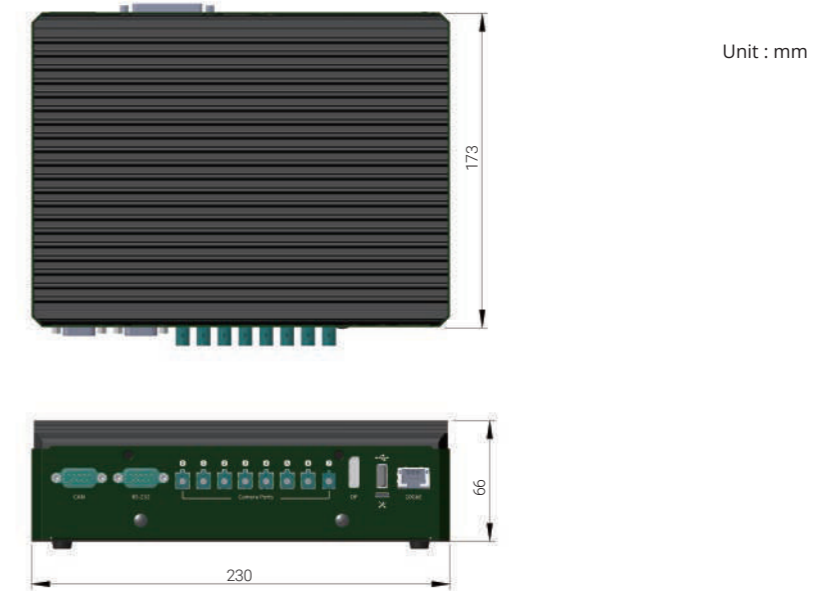

Ordering Information

Model No.	Product Description
NRU-110V	NVIDIA® Jetson AGX Xavier™ edge AI platform supporting 8x GMSL automotive cameras and 10G Ethernet
NRU-110V-F	NVIDIA® Jetson AGX Xavier™ edge AI platform supporting 8x GMSL automotive cameras and 10G Ethernet with fan kit

Optional Accessories

PA-120W-OW	120W AC/DC power adapter, 20V/6A; 18AWG/120cm; cord end terminals for terminal block, operating temperature : -30 to 70°C.
Fan kit	Fan kit with 92mm x 92mm fan for NRU-110V series
AC-AR0147-H40	On Semi AR0147 CMOS sensor camera; 1280x720 @30fps; LFM; HFOV 41, IP67; male FAKRA connector
AC-AR0147-H60	On Semi AR0147 CMOS sensor camera; 1280x720 @30fps; LFM; HFOV 59, IP67; male FAKRA connector
AC-AR0147-H90	On Semi AR0147 CMOS sensor camera; 1280x720 @30fps; LFM; HFOV 90, IP67; male FAKRA connector
AC-AR0147-H120	On Semi AR0147 CMOS sensor camera; 1280x720 @30fps; LFM; HFOV 125, IP67; male FAKRA connector
AC-AR0147-H190	On Semi AR0147 CMOS sensor camera; 1280x720 @30fps; LFM; HFOV 197, IP67; male FAKRA connector
FK-FF-CABLE-7M	7M FAKRA cable for cameras with male FAKRA connector; The waterproof end is black
FK-FF-CABLE-15M	15M FAKRA cable for cameras with male FAKRA connector; The waterproof end with heat shrink tube

Note: * Combined use of different FOV with the same CMOS sensor is verified on NRU series. Combined use of different FOV with varying CMOS sensors is not guaranteed. Please consult Neosys for feasibility.

NRU-51V Series

Rugged NVIDIA® Jetson Xavier™ NX GMSL2 Camera Sensor Hub for Autonomous Vehicles and Teleoperation

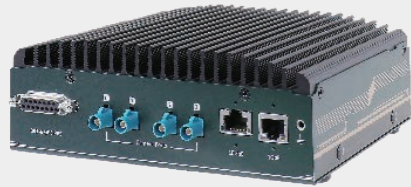

Key Features

- Powered by NVIDIA® Jetson Xavier™ NX SOM bundled with JetPack 4.6.1
- Rugged -25°C to 60°C fanless operation
- Support 4x GMSL2 automotive cameras via FAKRA Z connectors
- 1x 10GBASE-T 10Gb and 1x 1GBASE-T 1Gb Ethernet port
- 2x mini-PCIe sockets for WiFi/ GNSS/ NVMe/ CAN modules
- 1x M.2 3042/ 3052 B key socket for 4G/ 5G mobile communication
- 1x isolated CAN, 1x configurable RS232/ 422/ 485 port, and 1x GPS PPS input
- 8V to 35V wide-range DC input with built-in ignition power control



Preliminary

Introduction

NRU-51V is a rugged Jetson Xavier™ NX computer supporting GMSL2 cameras that can act either as a sensor hub or a perception unit for ADAS, teleoperation, autonomous mobile robots, and autonomous vehicles.

By supporting GMSL2 automotive cameras, they enable NRU-51V with greater vision capability by taking advantage of advanced features such as IP67 waterproof, high dynamic range (>120dB 120dB HDR), auto white balance (AWB), and LED flicker mitigation (LFM). NRU-51V can obtain high-quality images with minimal latency regardless of lighting conditions, from bright sunny days to pitch-black nights. Moreover, it has a unique synchronization mechanism capable of acquiring images from four GMSL2 cameras simultaneously within microseconds channel-to-channel skew. It can further accept GPS PPS signal to align image data with LIDAR or synchronize cameras on other systems.

Thanks to the great power efficiency of NVIDIA® Jetson Xavier™ NX SOM, NRU-51V delivers 21 TOPS inference performance in its 15W power package. Users can transfer raw camera images through its built-in 10GBASE-T Ethernet to another GPU server for perception processing, but also leverage its significant TOPS for real-time object or ROI detection. For teleoperation applications, users can utilize its hardware H.264/265 video codec, to encode video streams from four GMSL2 cameras in real-time and transmit the live video feed to a driver at a remote location via 5G telecommunication with minimum latency.

The combination of GMSL2 interface and Jetson Xavier™ NX makes NRU-51V much more than just a simple edge AI computer. With greater vision brought by automotive cameras plus I/O interfaces such as 10GbE, CAN 2.0, and M.2 for 5G broadband, NRU-51V plays a central role in a moving platform, as a sensor hub for ADAS, a perception unit for AGV/ AMR, or a teleoperation controller for off-highway vehicles.

Specifications

System Core		Power Supply	
Processor	NVIDIA® Jetson Xavier™ NX system-on-module (SOM), comprising NVIDIA® Volta GPU and Carmel CPU	DC Input	1x 3-pin pluggable terminal block for 8V to 35V DC input and ignition power control (V+/ GND/ IGN)
Memory	8GB/ 16GB LPDDR4x (Xavier NX 8GB/ 16GB) @ 1600/ 1866 MHz on SOM (15W/ 20W TDP mode)	Mechanical	
eMMC	16GB eMMC 5.1 on SOM	Dimension	173 mm (W) x 144 mm (D) x 60 mm (H)
Panel I/O Interface		Weight	1.4 kg
GMSL2 Camera	4x GMSL2 FAKRA Z connectors, supporting 4x 1920x1080 @ 30 FPS camera input	Mounting	Wall-mount bracket (optional)
Ethernet Port	1x 10GBASE-T 10GbE port with screw-lock 1x 1GBASE-T 1GbE port with screw-lock	Environmental	
USB	2x USB 3.1 Gen1 ports (total 5 Gbps shared with M.2 B key) 1x micro USB (OTG only)	Operating Temperature	-25°C to 60°C with passive cooling (15W TDP mode) * -25°C to 70°C with optional fan kit (15W TDP mode) *
Video Port	1x DisplayPort, supporting 3840x2160 at 60Hz	Storage Temperature	-40°C ~ 85°C
Serial Port	1x hardware configurable RS-232/ 422/ 485 port	Humidity	10% ~ 90%, non-condensing
CAN Bus	1x isolated CAN 2.0 port	Vibration	Operating, MIL-STD-810G, Method 514.7, Category 4 (pending)
Isolated DIO	1x GPS PPS input, 3-CH isolated DI and 4-CH isolated DO	Shock	Operating, MIL-STD-810G, Method 516.7, Procedure I (pending)
Micro SD	1x front-accessible microSD card slot	EMC	CE/FCC Class A, according to EN 55032 & EN 55035 (pending)
Ground Terminal	1x M4 ground terminal for chassis ESD shielding	<small>* For sub-zero and over 60°C operating temperature, a wide temperature SD card / NVMe is required.</small>	
Internal I/O Interface			
Mini PCI Express	1x full-size mini PCI Express socket (PCIe + USB 2.0) for WiFi, NVMe storage 1x full-size mini PCI Express socket (USB 2.0) for GNSS, V2X, or CAN		
M.2	1x M.2 3042/ 3052 B key (USB 3.1 Gen 1 + USB 2.0) for 4G/5G module with dual SIM support (1x front-accessible, 1x internal)		

Appearance

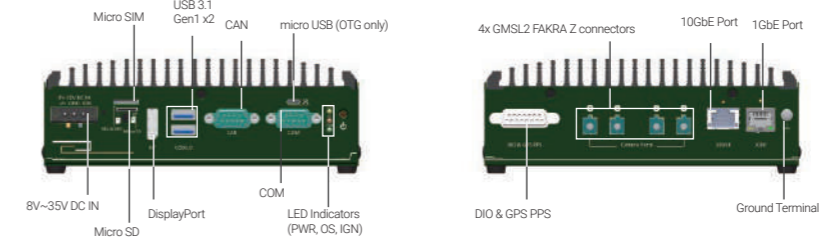

Dimensions

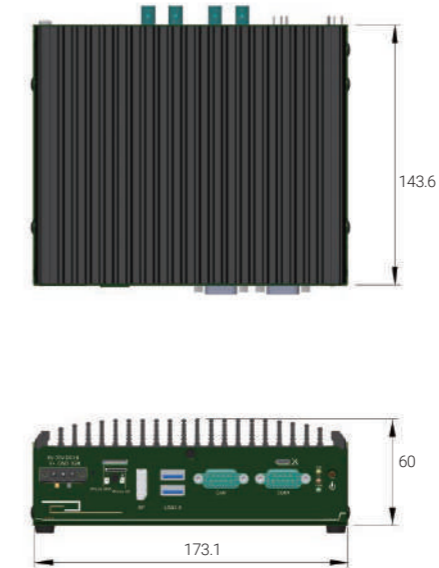

Ordering Information

Model No.	Product Description
NRU-51V-8GB	Rugged NVIDIA® Jetson Xavier™ NX (8GB) GMSL2 Camera Sensor Hub
NRU-51V-16GB	Rugged NVIDIA® Jetson Xavier™ NX (16GB) GMSL2 Camera Sensor Hub

Optional Accessories

AC-IMX390-H60	Sony IMX390 CMOS sensor camera; 1920x1080 @ 30fps; LFM; HFOV 63.9°; IP67+IP69K; -40°C to 85°C operating temperature; male FAKRA connector; active alignment; without lens cap	AC-AR0233-H120-60FPS	Onsemi AR0233 CMOS sensor camera; 1920x1080 @ 60fps; LFM; HFOV 118°; IP67; -40°C to 70°C operating temperature; male FAKRA connector
AC-IMX390-H120	Sony IMX390 CMOS sensor camera; 1920x1080 @ 30fps; LFM; HFOV 120.6°; IP67+IP69K; -40°C to 85°C operating temperature; male FAKRA connector; active alignment; without lens cap	AC-AR0233-H190-60FPS	Onsemi AR0233 CMOS sensor camera; 1920x1080 @ 60fps; LFM; HFOV 196°; IP67; -40°C to 70°C operating temperature; male FAKRA connector; without lens cap
AC-IMX390-H190	Sony IMX390 CMOS sensor camera; 1920x1080 @ 30fps; LFM; HFOV 186°; IP67+IP69K; -40°C to 85°C operating temperature; male FAKRA connector; active alignment; without lens cap	PA-60W-OW	60W AC/ DC power adapter 12V/ 5A; cord end terminals for terminal block, operating temperature: -30 to 60°C
AC-AR0233-H60	Onsemi AR0233 CMOS sensor camera; 1920x1080 @ 30fps; LFM; HFOV 60°; IP67; -40°C to 85°C operating temperature; male FAKRA connector	PA-120W-OW	120W AC/ DC power adapter 20V/ 6A; 18AWG/ 120cm; cord end terminals for terminal block, operating temperature: -30 to 70°C
AC-AR0233-H120	Onsemi AR0233 CMOS sensor camera; 1920x1080 @ 30fps; LFM; HFOV 118°; IP67; -40°C to 85°C operating temperature; male FAKRA connector	Risr-M2M-mPCIe	NGFF M.2 2242 key M to mini-PCIe adapter
AC-AR0233-H190	Onsemi AR0233 CMOS sensor camera; 1920x1080 @ 30fps; LFM; HFOV 196°; IP67; -40°C to 85°C operating temperature; male FAKRA connector; without lens cap	Wmkit-NRU-50	Wall mount kit for NRU-50 series, including wall mount brackets and screws
AC-AR0233-H60-60FPS	Onsemi AR0233 CMOS sensor camera; 1920x1080 @ 60fps; LFM; HFOV 60°; IP67; -40°C to 70°C operating temperature; male FAKRA connector	Tpkit-NRU-50	3 pcs of 30x30x2 mm thermal pad for mPCIe modules with the max component height between 1.3 mm and 2.4 mm, and M.2 B key modules with the max component height between 0.7 mm and 2.0 mm
		FK-FF-CABLE-7M	7M FAKRA cable for cameras with male FAKRA connector; the waterproof end is black
		FK-FF-CABLE-15M	15M FAKRA cable for cameras with male FAKRA connector; the waterproof end has heat shrink tube

PCIe-GL26

AI-enabled 6-port GMSL2 Camera Frame Grabber Card

Key Features

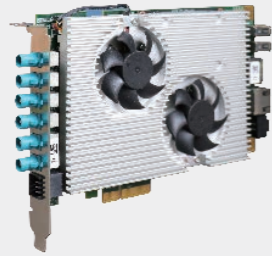

- 6x GMSL2 FAKRA Z inputs supporting automotive GMSL2 cameras
- Turnkey solution with pre-installed GMSL2 camera driver for selected cameras
- Powered by NVIDIA® Jetson Xavier™ NX bundled with JetPack 4.6.1
- 21 TOPS AI performance with up to 22 streams simultaneous 1080p@30FPS video encoding capability
- x2 Gen3 PCI Express interface offering 10Gb/s total bandwidth
- 1x GPS PPS input for frame sync calibration
- 1x isolated CAN 2.0 and 1x RS232
- -25°C to 60°C operating temperature with airflow

Introduction

PCIe-GL26 is an AI-enabled automotive six-port GMSL2 camera frame grabber card. It is a turnkey industrial-grade frame grabber solution that incorporates drivers for selected GMSL2 cameras with video streaming sample codes.

PCIe-GL26 aims to provide superior outdoor vision capability with automotive GMSL2 camera connectivity to advanced x86 autonomous vehicle computing platforms. Automotive GMSL2 cameras are ideal for autonomous vehicle applications due to their advanced features, such as IP67 waterproof, high dynamic range (120dB HDR), auto white balance (AWB), and LED flicker mitigation (LFM). It also benefits computer vision applications in outdoor environments where illumination conditions are constantly changing. Powerful x86 computers with PCIe-GL26 can obtain high-quality images with minimal latency regardless of lighting conditions, from bright sunny days to pitch-black nights.

With a half-length, standard height, and single-slot form factor, PCIe-GL26 can be accommodated in most host computers with a PCIe expansion. With pre-built sample codes, a host computer can install up to four PCIe-GL26 cards and support up to 24x GMSL2 camera streams. Featuring a unique synchronization mechanism, it is capable of acquiring images from six GMSL2 cameras simultaneously within microseconds of channel-to-channel skew. It can also accept a GPS PPS signal to align image data with LIDAR or PCIe-GL26 in another host machine.

Powered by Jetson Xavier™ NX, PCIe-GL26 is much more than just a GMSL2 frame grabber card. With 21 TOPS AI performance, 6x GMSL2 camera inputs, 1x GPS PPS input, 1x RS232, and 1x isolated CAN 2.0, PCIe-GL26 is an AI camera sensor hub capable of sensor fusion and data pre-processing for ADAS or autonomous vehicles.

Specifications

System Core	
Processor	NVIDIA® Jetson Xavier™ NX System-on-Module (SOM), comprising of NVIDIA® Volta GPU and Carmel CPU
Memory	8GB/ 16GB LPDDR4x (Xavier NX 8GB/ 16GB) @ 1600/ 1866 MHz (15W/ 20W TDP mode)
eMMC	16GB eMMC 5.1 on SOM
Deployment I/O Interface	
Bus Interface	x2, Gen3 PCI Express
GMSL2	6x GMSL2 ports (3Gbps) FAKRA Z connectors
CAN bus	1x isolated CAN 2.0 port
Serial Port	1x RS-232 port
Isolated DIO	1x GPS PPS input
Development I/O Interface	
Ethernet port	1x Gigabit Ethernet
USB	2x USB 2.0 ports 1x micro USB (OTG)
Video Port	1x DisplayPort, supporting 3840x2160 at 60Hz
DC Input	12V DC power input (for development only)
Internal I/O Interface	
M.2 NVMe	1x M.2 2242 M key socket (PCIe Gen3 x1) for NVMe SSD
Mechanical	
Dimension	167.7 mm (W) x 111 mm (H)
Weight	0.43kg
Environmental	
Operating Temperature	-25°C to 60°C with airflow (20W TDP mode) * <small>* For sub-zero and over 60°C operating temperature, a wide temperature NVMe is required.</small>
Storage Temperature	-40°C ~85°C
Humidity	10%~90% , non-condensing
EMC	CE Class A, according to EN 55032/55035 FCC Class A, according to FCC Part 15, Subpart B

Ordering Information

Model No.	Product Description
PCIe-GL26-JXN8	AI-enabled 6-port GMSL2 camera frame grabber card powered by Jetson Xavier NX (8GB)
PCIe-GL26-JXN16	AI-enabled 6-port GMSL2 camera frame grabber card powered by Jetson Xavier NX (16GB)

Optional Accessories

PA-60W-OW	60W AC/ DC power adapter 12V/ 5A; cord end terminals for terminal block, operating temperature: -30 to 60°C
FK-FF-CABLE-7M	7M FAKRA cable for cameras with male FAKRA connector; the waterproof end is black
AC-IMX390-H60	Sony IMX390 CMOS sensor camera; 1920x1080 @ 30fps; LFM; HFOV 63.9°; IP67+IP69K; -40°C to 85°C operating temperature; male FAKRA connector; active alignment; without lens cap
AC-IMX390-H120	Sony IMX390 CMOS sensor camera; 1920x1080 @ 30fps; LFM; HFOV 120.6°; IP67+IP69K; -40°C to 85°C operating temperature; male FAKRA connector; active alignment; without lens cap
AC-IMX390-H190	Sony IMX390 CMOS sensor camera; 1920x1080 @ 30fps; LFM; HFOV 186°; IP67+IP69K; -40°C to 85°C operating temperature; male FAKRA connector; active alignment; without lens cap
AC-AR0233-H60	Onsemi AR0233 CMOS sensor camera; 1920x1080 @ 30fps; LFM; HFOV 60°; IP67; -40°C to 85°C operating temperature; male FAKRA connector
AC-AR0233-H120	Onsemi AR0233 CMOS sensor camera; 1920x1080 @ 30fps; LFM; HFOV 118°; IP67; -40°C to 85°C operating temperature; male FAKRA connector
AC-AR0233-H190	Onsemi AR0233 CMOS sensor camera; 1920x1080 @ 30fps; LFM; HFOV 196°; IP67; -40°C to 85°C operating temperature; male FAKRA connector; without lens cap
AC-AR0233-H60-60FPS	Onsemi AR0233 CMOS sensor camera; 1920x1080 @ 60fps; LFM; HFOV 60°; IP67; -40°C to 70°C operating temperature; male FAKRA connector
AC-AR0233-H120-60FPS	Onsemi AR0233 CMOS sensor camera; 1920x1080 @ 60fps; LFM; HFOV 118°; IP67; -40°C to 70°C operating temperature; male FAKRA connector
AC-AR0233-H190-60FPS	Onsemi AR0233 CMOS sensor camera; 1920x1080 @ 60fps; LFM; HFOV 196°; IP67; -40°C to 70°C operating temperature; male FAKRA connector; without lens cap

PCIe-NX154PoE

100 TOPS Intelligent Frame Grabber Card with 4x PoE+ ports for IVA or AI Inspection



CE FC

Key Features

- Powered by NVIDIA® Jetson Orin™ NX bundled with JetPack 5.1
- Single-slot half-length PCIe card form factor
- 4x PoE+ 2.5 GbE ports with a 50W total power budget
- 100 TOPS AI inference performance capable of up to four simultaneous streams of 4K@30FPS video decoding
- 1x isolated RS-485 and 1x RS-232
- x1 Gen2 PCI Express interface offering 2.5Gb/s total bandwidth
- -25°C to 60°C operating temperature with airflow

Preliminary

Introduction

PCIe-NX154PoE is an intelligent 4-port 2.5GbE PoE+ frame grabber card fueling 100 TOPS AI inference performance for modern vision inspection, intelligent video analytics and surveillance/ security applications. Powered by NVIDIA's Jetson Orin NX system-on-module, PCIe-NX154PoE delivers 100 INT8 TOPS AI performance via its 1024 CUDA cores, 32 Tensor cores and 2 NVDLA® engines. It also features four 2.5GbE PoE+ ports with a 50W total PoE power budget to connect and power industrial GigE cameras or IP cameras.

With a standard single-slot half-length PCIe card form factor and utilizing 2.5GbE for host communication, PCIe-NX154PoE can be installed into a single PCIe x4 slot while operate on Gen2 x1 signals. This makes it an easy integration into any existing computer system, such as a 19" rack-mount IPC or commercial off-the-shelf box PC. When installed into a vision computer system, PCIe-NX154PoE provides necessary camera connectivity, and it also offloads the deep-learning image processing from host CPU/GPU since image capture, video streaming, pre-processing, and inference are all computed on PCIe-NX154PoE.

Wide temperature -25°C to 60°C operation capability, and compatibility with Windows and Linux operating systems make PCIe-NX154PoE the perfect upgrade for legacy machine vision systems to leverage deep learning-based image processing such as object detection, classification, tracking, facial recognition, etc. It's a revolutionary frame grabber card with intelligence for next-generation computer vision applications.

Specifications

System Core		Development I/O Interface	
Processor	Supporting NVIDIA® Jetson Orin™ NX system-on-module (SOM), comprising NVIDIA® Ampere GPU and ARM Cortex CPU	Video Port	1x DisplayPort, supporting 3840x2160 at 60Hz
Memory	8GB/ 16GB LPDDR5 @ 3200 MHz on SOM	DC Input	12V DC power input (for standalone development, or when total power consumption is more than 66W)
Storage Interface		Mechanical	
M.2 NVMe	1x M.2 2242 M key socket (PCIe Gen4 x2) for NVMe SSD	Dimension	167.7 mm (W) x 111 mm (H)
Deployment I/O Interface		Weight	TBD
Bus Interface	x1, Gen2 PCI Express	Environmental	
PoE	4x IEEE 802.3at PoE+. Max 25.5W per port. Total 50W power budget for 4 ports	Operating Temperature	-25°C to 60°C with airflow (20W TDP mode) *
Ethernet	4x 2.5GBASE-T Ethernet ports	Storage Temperature	-40°C ~85°C
Serial Port	1x RS-232 port and 1x isolated RS-485 port	Humidity	10%~90% , non-condensing
Development I/O Interface		EMC	CE Class A, according to EN 55032/55035 FCC Class A, according to FCC Part 15, Subpart B
Ethernet port	1x Gigabit Ethernet	* For sub-zero and over 60°C operating temperature, a wide temperature NVMe is required.	
USB	2x USB 2.0 ports 1x micro USB (OTG)		

Ordering Information

Model No.	Product Description
PCIe-NX154-JON8	100 TOPS Intelligent Frame Grabber with 4x PoE+ GbE ports by Jetson Orin NX (8GB)
PCIe-NX154-JON16	100 TOPS Intelligent Frame Grabber with 4x PoE+ GbE ports by Jetson Orin NX (16GB)

Optional Accessories

PA-60W-OW	60W AC/ DC power adapter 12V/ 5A; cord end terminals for terminal block, operating temperature: -30 to 60°C
-----------	---

PCIe-NX156U3

100 TOPS Intelligent Frame Grabber Card with 6x USB 3.2 ports for AI Inspection



CE FC

Key Features

- Powered by NVIDIA® Jetson Orin™ NX bundled with JetPack 5.1
- Single-slot width, standard PCIe half-length card form factor
- 6x USB 3.2 ports, each port with user-configurable 900mA and 1500mA current limit
- 100 TOPS AI inference performance
- Software-programmable per-port power on/off control
- 1x isolated RS-485 and 1x RS-232
- x1 Gen2 PCI Express interface offering 2.5Gb/s total bandwidth
- -25°C to 60°C operating temperature with airflow

Preliminary

Introduction

PCIe-NX156U3 is an intelligent 6-port USB 3.2 frame grabber card powered by NVIDIA's Jetson Orin NX designed to enable AI capabilities for modern vision inspections. It delivers 100 INT8 TOPS AI performance via its 1024 CUDA cores, 32 Tensor cores, and 2 NVDLA® engines. It also features two USB 3.2 Gen2 ports and four USB 3.2 Gen1 ports; each port provides 10 Gbps (Gen2) or 5 Gbps (Gen1) data bandwidth, and up to 1500mA current for USB camera connectivity.

PCIe-NX156U3 aims to enable AI inference and increase USB camera connectivity for existing 19" rack-mount or commercial off-the-shelf box AOI systems. With a standard single-slot half-length PCIe card form factor, PCIe-NX156U3 communicates with the host via the PCIe x4 slot Gen2 x1 signal. Its AI capabilities offloads deep-learning vision computing from the host computer, actions such as image capture, pre-processing, and inference are all performed by PCIe-NX156U3 while utilizing minimum host computer resources.

Capable of wide temperature -25°C to 60°C operation and Windows and Linux OS compatibility make PCIe-NX156U3 the perfect upgrade for legacy machine vision systems to leverage deep learning-based image processing such as package inspection, object sorting, surface defect detection, assembly verification, and robotic guidance, etc. It is a revolutionary AI-enabling frame grabber card for next-generation inspection applications.

Specifications

System Core		Deployment I/O Interface	
Processor	Supporting NVIDIA® Jetson Orin™ NX system-on-module (SOM), comprising NVIDIA® Ampere GPU and ARM Cortex CPU	Video Port	1x DisplayPort, supporting 3840x2160 at 60Hz
Memory	8GB/ 16GB LPDDR5 @ 3200 MHz on SOM	DC Input	12V DC power input (for standalone development, or when total power consumption is more than 66W)
Storage Interface		Mechanical	
M.2 NVMe	1x M.2 2242 M key socket (PCIe Gen4 x2) for NVMe SSD	Dimension	167.7 mm (W) x 111 mm (H)
Deployment I/O Interface		Weight	TBD
Bus Interface	x1, Gen2 PCI Express	Environmental	
USB	2x USB 3.2 Gen2 (10 Gbps) ports 4x USB 3.2 Gen1 (5 Gbps) ports	Operating Temperature	-25°C to 60°C with airflow (20W TDP mode) *
Serial Port	1x RS-232 port and 1x isolated RS-485 port	Storage Temperature	-40°C ~85°C
Development I/O Interface		Humidity	10%~90% , non-condensing
Ethernet port	1x Gigabit Ethernet	EMC	CE Class A, according to EN 55032/55035 FCC Class A, according to FCC Part 15, Subpart B
USB	2x USB 2.0 ports 1x micro USB (OTG)	* For sub-zero and over 60°C operating temperature, a wide temperature NVMe is required.	

Ordering Information

Model No.	Product Description
PCIe-NX156-JON8	100 TOPS Intelligent Frame Grabber with 6x USB 3.2 ports by Jetson Orin NX (8GB)
PCIe-NX156-JON16	100 TOPS Intelligent Frame Grabber with 6x USB 3.2 ports by Jetson Orin NX (16GB)

Optional Accessories

PA-60W-OW	60W AC/ DC power adapter 12V/ 5A; cord end terminals for terminal block, operating temperature: -30 to 60°C
-----------	---

PCIe-PoE312M

4-port Server-grade Gigabit 802.3at PoE+ Card with M12 x-coded Connectors



CE FC

Key Features

- Intel® I350 server-grade Gigabit Ethernet controller
- Four M12 x-coded connectors with patent-pending housing design
- x4, Gen2 PCI Express interface offering 2GB/s total bandwidth
- Compliant with IEEE 802.3at to deliver up to 25.5 W per port
- Supports 9.5 kB jumbo frame, teaming and IEEE 1588
- Per-port PoE+ power on/off control

*R.O.C Patent No. I711236

Introduction

Introducing the world's first PCIe card with M12 x-coded connectors, it features Gigabit Ethernet and PoE+ functionalities. Thanks to Neosys' patent-pending housing design, PCIe-PoE312M's M12 connectors utilizes a CNC-milled aluminum block as its connector housing screw that can withstand more than extra stress on the cable/connector. It offers extremely rugged and reliable cable connection for Ethernet or PoE devices.

PCIe-PoE312M has four Gigabit Ethernet ports integrated via server-grade Intel® I350 NIC. It features checksum offloading, segmentation offloading and intelligent interrupt generation/moderation to increase overall Ethernet performance and reduce CPU utilization. It also integrates IEEE 802.3at PoE+ PSE function to deliver up to 25.5W to attached PD devices.

For fast-growing IoT, edge computing and rugged surveillance applications, reliable Ethernet connection is indispensable. Neosys' PCIe-PoE312M combines reinforced M12 connectors, PoE+ and Gigabit Ethernet to provide unparalleled connection ruggedness for most off-the-shelf computers.

Specifications

Bus Interface	x4, Gen2 PCI Express
Gigabit Ethernet Port	4x ports by Intel® I350-AM4 NIC supporting 9.5 kB jumbo frame, teaming and IEEE 1588
Port Connector	M12 x-coded connector with Neosys patent-pending housing
PoE Capability	In compliant with IEEE 802.3at-2009 (PoE+), each port delivers up to 25.5 W of power
Cable Requirement	CAT-5e or CAT-6 cable, 100 meters maximum
Power Requirement	Maximum 1.2 A @ 3.3 V from PCI Express bus Maximum 9.6 A @ 12 V from PCI Express bus or on-board 4-pin power connector
Operating Temperature	0°C ~ 55°C with air flow
Dimension	167 mm (L) x 111 mm (H) x 20 mm (W)*

*PCIe-PoE312M is wider than the standard PCIe card and may cause mechanical interference with the card next to it. It is recommended to leave the slot on the right empty. If you must install another card on the right, please proceed with caution!

Ordering Information

Model No.	Product Description
PCIe-PoE312M	4-port server-grade Gigabit 802.3at PoE+ card with M12 x-coded connectors

Optional Accessories

Cbl-M12X8M-RJ45-500CM	M12 (8-pole-X-coded) to RJ45, CAT6, Length : 500CM
Cbl-M12X8M-RJ45-1000CM	M12 (8-pole-X-coded) to RJ45, CAT6, Length : 1000CM



Surveillance/ Video Analytics



NRU-220S Series

NVIDIA® Jetson AGX Orin™ AI NVR for Intelligent Video Analytics

Key Features

- Powered by NVIDIA® Jetson AGX Orin™ SoM bundled with JetPack 5.0.2
- 2x 2.5 Gigabit Ethernet + 4x IEEE 802.3at Gigabit PoE+ ports
- 2x front-accessible 2.5" HDD trays
- 1x M.2 2280 M key socket for NVMe SSD
- 2x mini-PCIe sockets for WiFi/ GNSS/ NVMe/ CAN modules
- 1x 3042/ 3052 M.2 B key socket for 4G/5G mobile communication
- 1x isolated RS-485 and 2x RS232 ports
- 8V to 48V wide-range DC input with built-in ignition power control



CE FC

Preliminary

Introduction

NRU-220S series is a one-stop AI NVR real-time inference and video transcoder powered by NVIDIA Jetson AGX Orin. Its fanless design and wide-temperature operation capability makes it ideal for stationary or mobile deployment applications.

Powered by NVIDIA® Jetson AGX Orin™ 32GB/ 64GB system-on-module (SOM), it comprises an Ampere GPU with up to 2048 CUDA cores, 64 Tensor cores, 2x NVDLA 2.0 Engines that offer a total of 275 sparse TOPS (INT8) AI inference and video transcoding capability of up to twenty-two 1080P video streams simultaneously.

NRU-220S offers four 802.3at PoE ports sharing 1 Gigabit bandwidth; each port can supply up to 25.5W of power to IP cameras. The additional two 2.5GbE ports is ideal for surveillance applications requiring more IP camera connections, or higher bandwidth connections to the backend. In addition to 64GB eMMC on the Orin module and an M.2 2280 NVMe socket for fast SSD read/write, NRU-220S is equipped with two front-accessible 2.5" SSD trays for storage expansion. It also has two mini-PCIe sockets for CAN/ COM/ WiFi modules and one M.2 B key socket for 4G LTE/5G NR mobile communications.

In addition to the above mentioned connectivity, the system also includes a wide range of NVIDIA AI tools, and modern deep learning frameworks. NRU-220S brings real-time video inference to the edge for surveillance, predictive maintenance, and intelligent transportation system (ITS) applications. Furthermore, with Neousys' unique damping bracket design, ignition power control, and 8-48V wide-range DC power input, NRU-220S is also ideal for in-vehicle deployment. Last but not least, NRU-220S comes with a derivative model, NRU-222S, incorporating M12 connectors for applications in shock and vibration environments that require extreme rugged connections, such as for agriculture, construction, and mining machinery.

NRU-220S series is Neousys' response to edge AI performance demands in a compact form factor with fanless wide-temperature operation.

Specifications

	NRU-220S	NRU-222S		NRU-220S	NRU-222S
System Core			Storage		
Processor	Supporting NVIDIA® Jetson AGX Orin™ System-on-Module (SOM), comprising NVIDIA® Ampere GPU and Arm Cortex-A78AE CPU		SATA HDD	2x front-accessible 2.5" 7mm SSD	
Memory	32GB/ 64GB LPDDR5 (AGX Orin 32GB/ 64GB) @ 3200 MHz on SOM		M.2 NVMe	1x M.2 2280 M key NVMe socket (PCIe Gen4x2) for NVMe SSD	
eMMC	64GB eMMC 5.1 on SOM		Power Supply		
Panel I/O Interface			DC Input	1x 3-pin pluggable terminal block for 8V to 48V DC input and ignition power control (IGN/ GND/ V+)	1x M12 A-coded 5-pin for 8V to 48V DC input and ignition power control (IGN/ GND/ V+)
Ethernet Port	6x RJ45 with screw-lock	6x M12 X-coded 8-pin	Mechanical		
PoE Capability	IEEE 802.3at PoE+ PSE for Port 3 – Port 6, 100W total power budget		System LED	PWR: System carrier board power status OS: Jetson OS boot status IGN: Ignition power signal	
USB	1x USB 3.1 Gen1 port 2x USB 2.0 ports 1x USB Type C (Debug Only)		Dimension	230 mm (W) x 173 mm (D) x 66 mm (H)	
Video Port	1x DisplayPort, supporting 3840x2160 at 60Hz		Weight	TBD	
Serial Port	1x Isolated RS-485 port and 2x RS-232 ports		Mounting	Wall-mount with damping brackets	
CAN bus	2x CAN 2.0 port		Environmental		
Isolated DIO	4-CH isolated DI and 4-CH isolated DO		Operating Temperature	-25°C ~ 70°C with passive cooling (30W TDP mode) *	
Internal I/O Interface			Storage Temperature	-40°C ~ 85°C	
Mini PCI Express	1x full-size mini PCI Express socket (PCIe + USB 2.0) for WiFi 6 or CAN 1x full-size mini PCI Express socket (USB 2.0) for GNSS or 4G LTE		Humidity	10% ~ 90%, non-condensing	
M.2	1x M.2 3042/3052 B key (USB 3.1 Gen 1 + USB 2.0) for LTE/5G module with dual micro SIM support		Vibration	Operating, MIL-STD-810H, Method 514.8, Category 4	
			Shock	Operating, MIL-STD-810H, Method 516.8, Procedure I	
			EMC	CE/ FCC Class A, according to EN 55032 & EN 55035 EN 50121-3 (EN 50155:2017, Clause 13.4.8)	

* For sub-zero and over 60°C operating temperature, a wide temperature HDD or Solid State Disk (SSD) is required.

Appearance



Dimensions



Unit : mm

Ordering Information

Model No.	Product Description
NRU-220S	NVIDIA® Jetson AGX Orin™ AI NVR for Intelligent Video Analytics with RJ45 Ethernet
NRU-222S	NVIDIA® Jetson AGX Orin™ AI NVR for Intelligent Video Analytics with M12 Ethernet

Optional Accessories

PA-160W-OW	160W AC-DC power adapter 20V/8A; 18AWG/120cm; cord end terminals for terminal block, operating temperature: -30 to 70°C.
PA-120W-OW	120W AC/DC power adapter 20V/6A; 18AWG/120cm; cord end terminals for terminal block, operating temperature: -30 to 70°C.
AccsyBx-FAN-NRU-100	Fan kit with 92mm x 92mm fan for NRU-220S series

NRU-120S Series

NVIDIA® Jetson AGX Xavier™ AI NVR for Intelligent Video Analytics

Key Features

- Powered by NVIDIA® Jetson AGX Xavier™ SOM bundled with JetPack 4.4
- 4x IEEE 802.3at Gigabit PoE+ ports with screw-lock
- 2x front-accessible 2.5" HDD/SSD trays
- 1x M.2 2280 M key socket for NVMe SSD
- 1x mini PCIe socket for WIFI/4G module
- 1x isolated CAN bus port and 1x RS232 port with flow control
- 1x GPS PPS input, 3-CH isolated DI and 4-CH isolated DO
- 8 to 35V wide-range DC input with built-in ignition power control



Introduction

NRU-120S series is a new rugged edge AI-based video analytics solution capable of video recording, transcoding, real-time inference, etc. Powered by NVIDIA® Jetson AGX Xavier™ system-on-module (SOM), it comprises of an 8-core ARM CPU and NVIDIA Volta GPU with 512 CUDA cores and 64 Tensor cores that offer 11 TFLOPS FP16 or 22 TOPS INT8 computing power.

Benefiting from the low-power design of NVIDIA® Jetson AGX Xavier™, NRU-120S offers significant inference performance while consuming only 30W of power. The efficient power design and the compact form factor make it the perfect edge AI solution for both stationary and mobile applications.

NRU-120S offers four 802.3at Gigabit PoE+ ports; each port can supply up to 25.5W of power to PD devices such as IP cameras and industrial cameras. In addition to 32GB eMMC on the Xavier module, NRU-120S further incorporates two front-accessible 2.5" HDD/ SSD trays for expanding storage capacity and an M.2 2280 NVMe socket for fast SSD read/write performance. It also has one mini-PCIe socket for WIFI and 4G module, as well as 1 GPS PPS input, 3-CH isolated DI and 4-CH isolated DO for communication with external devices.

By integrating PoE+ connectivity, a wide range of NVIDIA AI tools, and modern deep learning frameworks, NRU-120S pushes real-time image and video inference to the edge. It is a one-stop AI-based video analytics solution that offers 802.3at PoE+ camera connections, video decoding, video streaming, video recording, and edge AI inference. With Neousys' unique damping bracket design, ignition power control, and wide voltage power supply, NRU-120S is an ideal video inference platform for autonomous machines, predictive maintenance, law enforcement, and smart city applications.

Specifications

System Core		Power Supply	
Processor	Supporting NVIDIA® Jetson AGX Xavier™ system-on-module, comprising of NVIDIA® Volta GPU and Carmel CPU	DC Input	1x 3-pin pluggable terminal block for 8 to 35V DC input (IGN/ GND/ V+)
Memory	32GB LPDDR4x @ 2133 MHz on SOM	Mechanical	
eMMC	32GB eMMC 5.1 on SOM	Dimension	230 mm (W) x 173 mm (D) x 66 mm (H)
I/O Interface		Weight	2.7 kg (excluding damping bracket)
PoE+	4x IEEE 802.3at (25.5W) Gigabit PoE+ ports by Intel® I350	Mounting	Wall-mount with damping brackets (Standard)
CAN	1x isolated CAN 2.0 port	Environmental	
Isolated DIO	1x GPS PPS input. 3-CH isolated DI and 4-CH isolated DO	Operating Temperature	-25°C ~ 50°C with passive cooling (MAX TDP mode) * -25°C ~ 70°C with passive cooling (30W TDP mode) * -25°C ~ 70°C with optional fan kit (all modes) *
USB	3x USB 3.1 Gen1 (5 Gbps) ports	Storage Temperature	-40°C ~ 85°C
Video Port	2x DisplayPort, supporting 3840x2160 at 60Hz	Humidity	10% ~ 90%, non-condensing
Serial Port	1x RS-232 port with flow control	Vibration	Operating, MIL-STD-810G, Method 514.7, Category 4
Storage Interface		Shock	Operating, MIL-STD-810G, Method 516.7, Procedure I
SATA HDD	2x front-accessible HDD trays for 2.5" HDD/SSD installation (up to 9.5mm height)	EMC	CE/ FCC Class A, according to EN 55032 & EN 55035
M.2 NVMe	1x M.2 2280 M key socket (PCIe Gen3 x2) for NVMe SSD	* For sub-zero and over 60°C operating temperature, a wide temperature HDD or Solid State Disk (SSD) is required.	
Internal Expansion Bus			
Mini PCI Express	1x full-size mini PCI Express socket with internal SIM socket		

Appearance

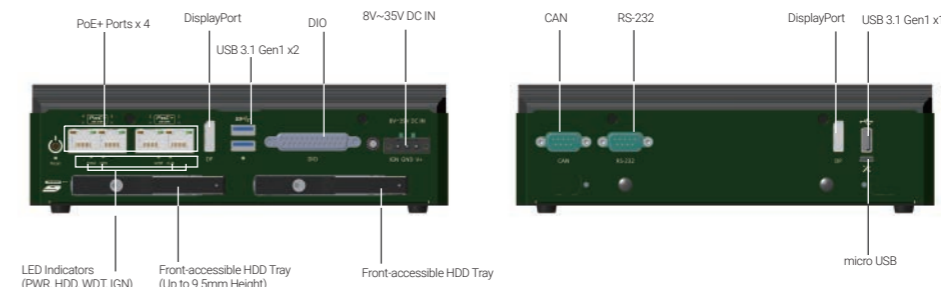

Dimensions



Ordering Information

Model No.	Product Description
NRU-120S	NVIDIA® Jetson AGX Xavier™ AI NVR for Intelligent Video Analytics
NRU-120S-F	NVIDIA® Jetson AGX Xavier™ AI NVR for Intelligent Video Analytics with Fan Kit

Optional Accessories

PA-160W-OW	160W AC-DC power adapter, 20V/8A; 18AWG/120cm; cord end terminals for terminal block, operating temperature : -30 to 70°C.
PA-120W-OW	120W AC/DC power adapter, 20V/6A; 18AWG/120cm; cord end terminals for terminal block, operating temperature : -30 to 70°C.
Fan kit	Fan kit with 92mm x 92mm fan for NRU-120S series

NRU-52S Series

Rugged NVIDIA® Jetson Xavier™ NX Edge AI Computer with 4x PoE++ Ports for Intelligent Video Analytics

Key Features

- Powered by NVIDIA® Jetson Xavier™ NX SOM bundled with JetPack 4.6.1
- Rugged -25°C to 70°C fanless operation
- 4x IEEE 802.3bt PoE++ GbE ports with screw-lock
- 2x mini-PCIe sockets for WIFI/GNSS/NVMe/CAN modules
- 1x 3042/3052 M.2 B key socket for 4G/5G mobile communication
- 1x hardware configurable RS232/RS422/RS485 port
- 8V to 35V wide-range DC input with built-in ignition power control
- MIL-STD-810G and EN 50155 certified



Preliminary

Introduction

NRU-52S is a rugged, wide temperature, fanless edge AI computer delivering 21 TOPS for AI-based video analytics applications requiring H.264/H.265 video decoding and real-time inference. Powered by NVIDIA® Jetson Xavier™ NX system on module (SOM), it comprises a 6-core ARM CPU and NVIDIA® Volta GPU with 384 CUDA cores, 48 Tensor cores, and 2 NVDLA (NVIDIA® deep learning accelerator).

Benefiting from the power-efficiency of NVIDIA® Jetson Xavier™ NX, which consumes only 15W of power, NRU-52S can decode up to 32 streams of 1080p video at 30 FPS, and also offer 21 TOPS inference performance. The low power consumption makes NRU-52S ideal for applications with a limited power source, such as in a robot, vehicle, or rolling stock. Also, with Neousys' industrial-grade thermal design, NRU-52S is ideal for edge deployments that require fanless wide temperature operations, such as at roadside, wayside, construction site, agriculture, or in a dusty factory.

NRU-52S offers four IEEE 802.3bt PoE++ ports, each port can supply up to 90W to IP cameras or PTZ speed dome cameras for AI-based detection, tracking, and recognition applications. NRU-52S also offers flexible expansions with two mPCIe sockets for NVMe storage, WIFI, GNSS, or V2X module; one M.2 B key for 4G LTE or 5G NR module with dedicated passive thermal design, and a total of five antenna holes for mobile broadband. It also has one hardware configurable RS232/RS422/RS485, 1 GPS PPS input, 3-CH isolated DI, and 4-CH isolated DO for communication with external devices.

By integrating PoE++ connectivity, 21 TOPS inference performance, a vast of NVIDIA® AI JetPack toolkits, NRU-52S can enable more possibilities for real-time video analytics such as autonomous machines, security alerts, law enforcement, and V2X applications. With its -25°C to 70°C fanless operation, wide-range DC input, ignition control, and 4G/ 5G connectivity, NRU-52S is not only for indoor/ stationary installations but also ideal for harsh edge deployments.

Specifications

System Core		Power Supply	
Processor	NVIDIA® Jetson Xavier™ NX system-on-module (SOM), comprising NVIDIA® Volta GPU and Carmel CPU	DC Input	1x 3-pin pluggable terminal block for 8V to 35V DC input and ignition power control (V+/ GND/ IGN)
Memory	8GB/ 16GB LPDDR4x (Xavier NX 8GB/ 16GB) @ 1600/ 1866 MHz on SOM (15W/ 20W TDP mode)	Mechanical	
eMMC	16GB eMMC 5.1 on SOM	Dimension	173 mm (W) x 144 mm (D) x 60 mm (H)
Panel I/O Interface		Weight	1.4 kg
Ethernet Port	4x Gigabit ports with screw-lock, share 1 Gbps total bandwidth	Mounting	Wall-mount bracket (optional)
PoE Capability	In compliant with IEEE 802.3bt PoE++ Type 3 and Type 4 PSE, maximum 90W output on single PoE++ port Compatible with 802.3at (PoE+) and 802.3af (PoE) PD	Environmental	
USB	2x USB 3.1 Gen1 ports (total 5 Gbps shared with M.2 B key)	Operating Temperature	-25°C ~ 70°C with passive cooling (15W TDP mode with 50W PoE++ power supply) -25°C ~ 70°C with optional fan kit (15W TDP mode with 144W PoE++ power supply)
Video Port	1x DisplayPort, supporting 3840x2160 at 60Hz	Storage Temperature	-40°C ~ 85°C
Serial Port	1x hardware configurable RS-232/422/485 port	Humidity	10% ~ 90%, non-condensing
CAN Bus	1x isolated CAN 2.0 port	Vibration	Operating, MIL-STD-810G, Method 514.7, Category 4
Isolated DIO	1x GPS PPS input, 3-CH isolated DI and 4-CH isolated DO	Shock	Operating, MIL-STD-810G, Method 516.7, Procedure I
Micro SD	1x front-accessible microSD card slot	EMC	CE/FCC Class A, according to EN 55032 & EN 55035 EN 50121-3 (EN 50155:2017, Clause 13.4.8)
Ground Terminal	1x M4 ground terminal for chassis ESD shielding	* For sub-zero and over 60°C operating temperature, a wide temperature HDD or Solid State Disk (SSD) is required.	
Internal I/O Interface			
Mini PCI Express	2x full-size mini PCI Express socket (PCIe + USB 2.0) for WIFI, GNSS, NVMe storage, V2X, or CAN modules		
M.2	1x 3042/3052 M.2 B key (USB 3.1 Gen 1 + USB 2.0) for 4G/5G module with dual SIM support (1x front-accessible, 1x internal)		

Appearance

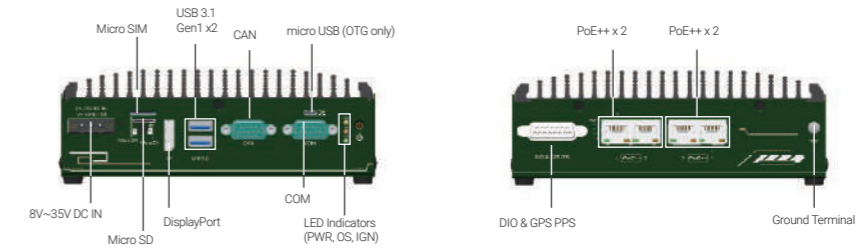

Dimensions

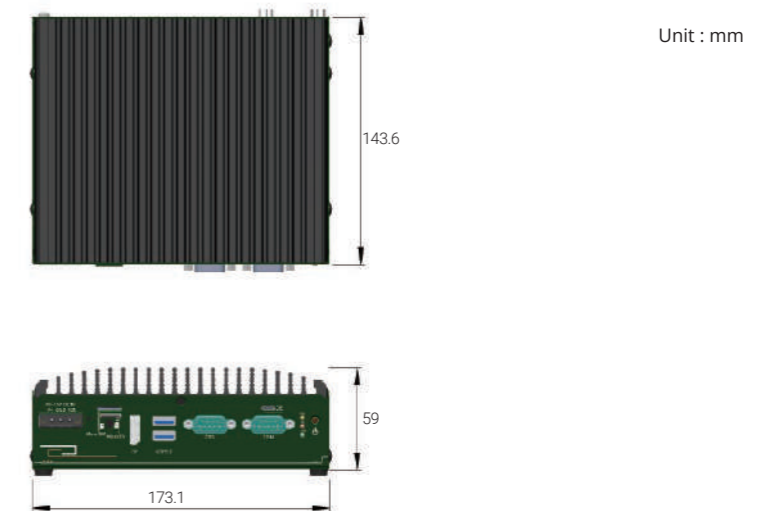

Ordering Information

Model No.	Product Description
NRU-52S-8GB	Rugged NVIDIA® Jetson Xavier™ NX (8GB) Edge AI Computer with 4x PoE++ Ports for Intelligent Video Analytics
NRU-52S-16GB	Rugged NVIDIA® Jetson Xavier™ NX (16GB) Edge AI Computer with 4x PoE++ Ports for Intelligent Video Analytics

Optional Accessories

PA-160W-OW	160W AC-DC power adapter, 20V/8A; 18AWG/120cm; cord end terminals for terminal block, operating temperature : -30 to 70°C.
PA-120W-OW	120W AC/DC power adapter, 20V/6A; 18AWG/120cm; cord end terminals for terminal block, operating temperature : -30 to 70°C.
Risr-M2M-mPCIe	NGFF M.2 2242 key M to mini-PCIe adapter
Wmkit-NRU-50	Wall mounting kit for NRU-50 series, including wall mounting brackets and screws
AccsyBx-FAN-NRU-50	Fan kit for NRU-50 series, including 92x92mm fan, fan frame, fan cable cover, and screws
Tpkit-NRU-50	3 pcs of 30x30x2 mm thermal pad for mPCIe modules with the max component height between 1.3 mm and 2.4 mm, and M.2 B key modules with the max component height between 0.7 mm and 2.0 mm

Nuvo-5608VR Series

Intel® 6th-Gen Core™ i7/i5/i3 Fanless Surveillance System with 8x PoE+, DIO, CAN bus and 2x 3.5" HDD Accommodation Supporting RAID 0/1

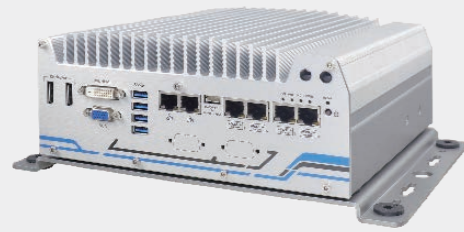

Key Features

- Supports Intel® 6th-Gen Core™ i7/ i5/ i3 LGA1151 socket-type processor
- 8x 802.3at PoE+ ports and 2x GbE ports
- 2x 3.5" HDD accommodation, support RAID 0/1 with over 24 TB capacity
- Dedicated HDD heat-spreader for optimized thermal performance
- 4x full-size mini-PCIe sockets with SIM support
- 4-CH isolated DI and 4-CH isolated DO
- 1x CAN 2.0 port
- 8 to 35V wide-range DC input with built-in ignition power control
- Patented damping brackets* to withstand 1 Grms Vibration



*R.O.C Patent No. M491752

Introduction

Nuvo-5608VR is Neousys' latest fanless surveillance system designed for real-time video analysis and streaming. It incorporates 6th-Gen Core™ i CPU, IP camera connectivity and massive storage capacity for emerging intelligent surveillance/ security applications.

Featuring eight Gigabit PoE+ ports, Nuvo-5608VR provides sufficient bandwidth to collect high-definition video streams from IP cameras, while its 6th-Gen Core™ i7 CPU is capable of performing real-time video analytics. It accommodates two 3.5" hard drives with RAID 0/ 1 configuration to support more than 24 TB storage capacity for recording 8-CH, 1080p@H.264 video for over 3 months.

Neousys' patented damping-bracket is shipped with Nuvo-5608VR to protect the system against vibration in harsh environmental conditions.

Being a rugged surveillance platform, Nuvo-5608VR is equipped with dedicated HDD heat-spreaders to maintain adequate HDD operating temperature and along with extra features such as DIO, CAN bus and ignition control, Nuvo-5608VR is the perfect fit for both stationary and mobile surveillance applications.

Specifications

System Core		Expansion Bus		
Processor	Supports 6th-Gen Intel® Core™ i7/ i5/ i3 LGA1151 CPU Intel® Core™ i7-6700 (8M Cache, 3.4/ 4.0 GHz, 65W TDP) Intel® Core™ i5-6500 (6M Cache, 3.2/ 3.6 GHz, 65W TDP) Intel® Core™ i3-6100 (3M Cache, 3.7 GHz, 51W TDP) Intel® Core™ i7-6700TE (8M Cache, 2.4/ 3.4 GHz, 35W TDP) Intel® Core™ i5-6500TE (6M Cache, 2.3/ 3.3 GHz, 35W TDP) Intel® Core™ i3-6100TE (4M Cache, 2.7 GHz, 35W TDP)	mini-PCIe	1x full-size mini-PCIe socket with panel-accessible SIM socket 1x full-size mini-PCIe socket with internal SIM socket (mux with mSATA) 2x full-size mini-PCIe sockets (USB signals only) with internal SIM sockets	
Chipset	Intel® Q170 platform controller hub	Power Supply		
Graphics	Integrated Intel® HD graphics 530	DC Input	1x 3-pin pluggable terminal block for 8 to 35V DC input (IGN/GND/V+)	
Memory	Up to 32 GB DDR4-2133 SDRAM (two SODIMM slots)	Remote Ctrl. & Status Output	1x 10-pin (2x5) wafer connector for remote on/off control and status LED output	
AMT	Supports AMT 11.0	Mechanical		
TPM	Supports TPM 2.0	Dimension	240 mm (W) x 225 mm (D) x 98 mm (H)	
I/O Interface		Weight	3.5 kg	
Ethernet port	2x Gigabit Ethernet ports by Intel® I219 and I210	Mounting	Wall-mount with damping brackets	
PoE+	8x IEEE 802.3at (25.5W) Gigabit PoE+ ports by Intel® I210, 120W total power budget*	Environmental		
USB 3.1	4x USB 3.1 ports via native XHCI controller	Operating Temperature	with 35W CPU -25°C ~ 70°C (with mSATA/ SSD) ** -10°C ~ 60°C (with 3.5" HDD) **/**	
USB 2.0	4x USB 2.0 ports	with 65W CPU -25°C ~ 50°C (with mSATA/ SSD) ** -10°C ~ 60°C (with 3.5" HDD) **/**	Storage Temperature	-40°C ~ 85°C
Video Port	1x stacked VGA + DVI-D 2x DisplayPorts, supporting 4K2K resolution	Humidity	10%~90% , non-condensing	
Serial Port	2x software-programmable RS-232/ 422/ 485 ports (COM1 & COM3) 1x RS-232 port (COM2)	Vibration	Operating, 1 Grms, 5-500 Hz, 3 Axes (w/ HDD and damping bracket installed, according to IEC60068-2-64)	
Isolated DIO	4x isolated DI and 4x isolated DO	Shock	Operating, 30 Grms, Half-sine 11 ms Duration (w/ HDD and damping bracket installed, according to IEC60068-2-27)	
CAN	1x CAN 2.0 port	EMC	CE/ FCC Class A, according to EN 55032 & EN 55024	
Audio	1x mic-in and 1x speaker-out			
Storage Interface				
SATA HDD	2x internal SATA port for 3.5" HDD installation, supporting RAID 0/ 1			
mSATA	1x full-size mSATA port (mux with mini-PCIe)			

* The total power budget for Nuvo-5608VR is related to input voltage. 120W total budget is available with 24 VDC input. When 12 VDC input is applied, the total power budget is limited to 100W.
** Operating temperature is verified with 100% CPU loading and 100% HDD loading applied using Passmark® BurnInTest 8.0. For detail testing criteria, please contact Neousys Technology.
*** Depending on the HDD selected, users may encounter performance degradation in sequential disk write at low/high ambient temperature. No data integrity issue was observed in -10°C ~ 60°C operating temperature range.

Appearance

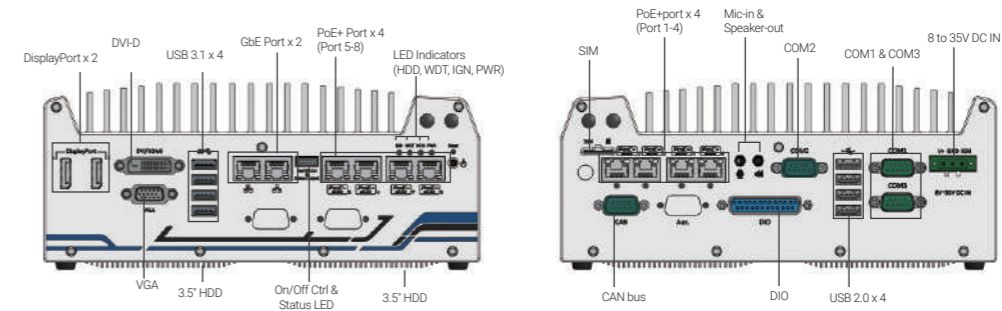

Dimensions

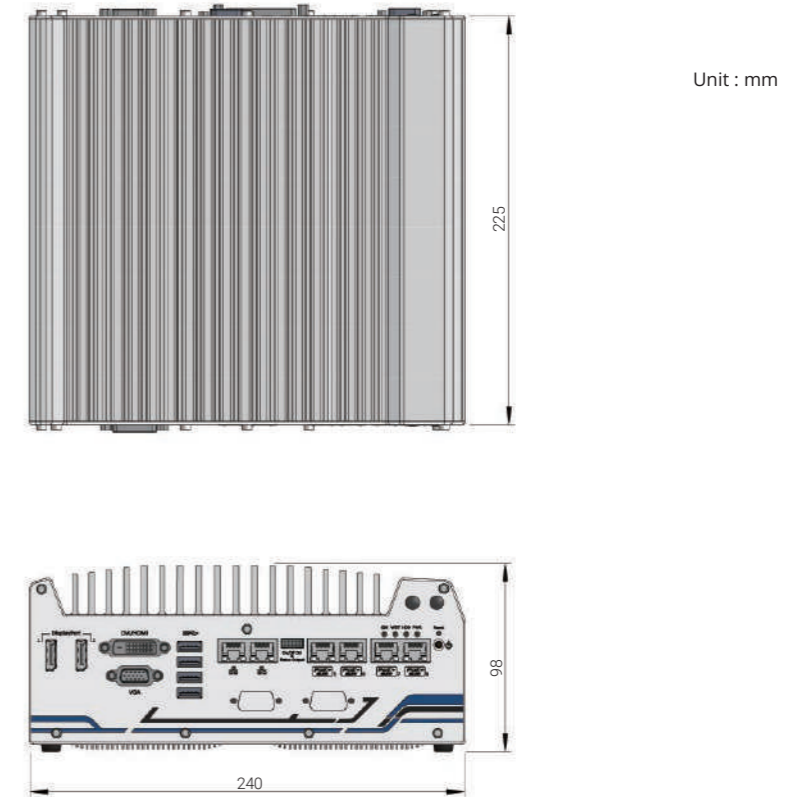

Ordering Information

Model No.	Product Description
Nuvo-5608VR	Intel® 6th-Gen Core™ fanless surveillance system with 8x PoE+ Ports, DIO, CAN bus and 2x 3.5" HDD RAID

Optional Accessories

PA-160W-OW	160W AC/DC power adapter 20V/8A;18AWGx4C/120cm; cord end terminals for terminal block, operating temperature : -30 to 70 °C.
PA-280W-ET2	280W AC/DC power adapter 24V/11.67A;16AWG/100cm; cord end terminals for terminal block, operating temperature : -30 to 60 °C.

PCIe-PoE425bt

4-port 2.5GBASE-T Network Adapter with IEEE 802.3bt PoE++ Capability

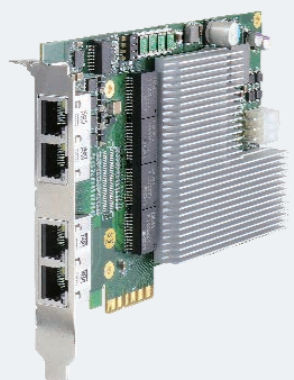

CE FC

Key Features

- Compliant with IEEE 802.3bt PoE++ PSE, provides up to 90W on a single port
- 4x IEEE 802.3bz 2.5GBASE-T Ethernet ports by Intel® I225-IT controller
- Supports 2.5G/ 1G/ 100M/ 10M link speed
- Available in RJ-45 connectors
- x4, Gen2 PCI Express interface
- Supports 9.5 kB jumbo frame, teaming and IEEE 1588
- Per-port PoE+ power on/ off control by software API

Preliminary

Introduction

Introducing one of the world's first 2.5G Ethernet card featuring IEEE 802.3bt PoE++ PSE capability! The PCIe-PoE425bt is a 4-port 2.5GBASE-T PoE++ card leveraging the cutting-edge Intel® I225 controller. It complies with IEEE 802.3bz standard to provide 2.5 Gbps bandwidth and is backward-compatible with 1000BASE-T, 100BASE-TX, and 10BASE-TE Ethernet.

In addition to the increase in bandwidth, the PCIe-PoE425bt also features IEEE 802.3bt PSE capability. IEEE 802.3bt, or PoE++, is the latest addition to Power over Ethernet specifications, allowing a single port to provide up to 90W of power supplied to PD over a standard CAT-5e or CAT-6 Ethernet cable. While COTS high PoE PTZ cameras and outdoor WIFI access points may require higher power than 30W, the PCIe-PoE425bt is particularly useful for directly connecting and powering these devices without an external PoE++ injector.

The PCIe-PoE425bt has four RJ-45 connectors for use with generic Ethernet cables. By incorporating 2.5GBASE-T and PoE++ technologies, the PCIe-PoE425bt is the ideal choice for machine vision and surveillance applications with advanced PoE devices, such as PTZ camera, high-performance WIFI access point and industrial NBASE-T camera.

Specifications

Bus Interface	x4, Gen2 PCI Express
# of 2.5G Port	4x 2.5G Ethernet ports by four Intel® I225-IT controllers, supporting 9.5 kB jumbo frame, teaming and IEEE 1588
Network Interface	IEEE 802.3 Ethernet interface for 2500BASE-T (802.3bz), 1000BASE-T (802.3ab), 100BASE-TX (802.3u), and 10BASE-TE (802.3)
PoE Capability	In compliant with IEEE 802.3bt PoE++ Type 3 and Type 4 PSE, maximal 90W output on a single PoE++ port Compatible with 802.3at (PoE+) and 802.3af (PoE) PD
Ethernet Connector	4x RJ-45 connectors
Cable Requirement	100 meters over CAT-5e or better Ethernet cable
Power Requirement	Jumper-select 12VDC input Maximum 5.5A@12V (66W) from PCIe gold finger connector Maximum 12A@12V (144W) from on-board 6-pin PCIe power connector
EMC	CE Class A, according to EN 55032/55035 FCC Class A, according to FCC Part 15, Subpart B
Operating Temperature	0°C ~ 55°C with airflow
Dimension	167.7mm (L) x 111.2mm (H) x 18.2mm (W)

Ordering Information

Model No.	Product Description
PCIe-PoE425bt	4-Port 2.5GbE 802.3bt PoE++ card with RJ45 connector

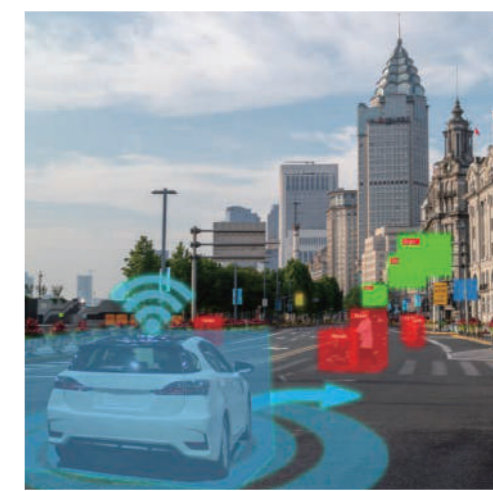

GPU Computing

AI

RGS-8805GC

AMD® EPYC™ 7003 "MILAN" Series Rugged HPC Server
Supporting NVIDIA® RTX A6000/ A4500, 2x 10G and 4x 1G Ethernet and 8~48V DC Input

Key Features

- Powered by AMD® EPYC™ 7003 series processors, supporting up to 64-core/ 128-thread
- Supports one NVIDIA® RTX A6000/ A4500 with proprietary heat dissipation
- Rugged -25°C to 60°C operation for edge applications
- 2x 10G Ethernet by Intel® X550-AT2 and 4x GbE by Intel® I350-AM4
- Supports 4x DDR4 RDIMM/ LRDIMM up to 512GB of memory
- Compact 2U 19" rack-mount enclosure with only 350mm depth
- Four easy-swappable 2.5" SATA trays for 7mm HDD/ SSD
- 8~48V wide-range DC input with built-in ignition power control



CE FC

Preliminary

Introduction

Imagine an HPC server unleashed from an air-conditioned data center room, roaming freely in the field! RGS-8805GC is just that, a rugged HPC server powered by the AMD EPYC™ 7003 series "MILAN" processor with up to 64-core/ 128-thread unparalleled computing power and 512GB memory capacity. Utilizing a unique partitioned enclosure design, it provides a highly effective airflow for CPU and other components to guarantee a reliable -25°C to 60°C operation for field deployment.

To fuel versatile advanced edge AI applications, RGS-8805GC can host one high-end NVIDIA® RTX A6000 or A4500 GPU which provides up to 38.7 TFLOPS FP32 or 309.7 TFLOPS tensor performance. It comes with a unique enclosure design that creates a sealed tunnel to efficiently dissipate the heat generated from the RTX GPU. RGS-8805GC offers an exceptional balance of CPU and GPU for modern edge AI applications, such as autonomous driving, DL-based vision inspection, and intelligent video analytics.

In terms of I/O connectivity, RGS-8805GC has two 10G Ethernet ports for high-speed data transmission that are backward compatible with 5GBASE-T and 2.5GBASE-T to work with NBASE-T industrial cameras; it has another four Gigabit PoE+ and four USB 3.1 Gen1 ports for connecting additional devices; and four easy-swappable 2.5" HDD trays for data storage. If that's not enough, RGS-8805 provides two x16 PCIe slots for installing additional I/O cards such as frame grabber or GMSL image capture cards. Not to mention that RGS-8805GC is one of few HPC servers that accept wide-range DC input, helping it to adapt to versatile deployment environments.

RGS-8805GC addresses the challenge of deploying a CPU/ GPU server to the field, where installation space, operating temperature, and power supply are some of the most commonly faced issues. A rugged HPC system that can be installed outside of an air-conditioned environment and capable of operating in harsh environments opens the door to new AI-assisted edge computing for more advanced telecom infrastructure, factory automation, ADAS, and V2X applications.

Specifications

System Core		Expansion Bus	
Processor	AMD® EPYC™ 7003 "Milan" series server CPU, up to 64-core/ 128-thread	M.2	1x M.2 3042/ 3052 B key with dual micro-SIM sockets for 4G/ 5G module
Graphics	Integrated graphics in ASPEED AST2500 BMC, supporting 1920x1200 resolution	Mini PCI Express	2x full-size mini PCI Express sockets with USIM support
Memory	4x RDIMM/ LRDIMM slots, supporting up to 512GB DDR4-3200	Power Supply	
TPM	Supports TPM 2.0	DC Input	2x 4-pin 7.62mm pitch pluggable terminal block for 8 to 48V DC input and ignition control input
I/O Interface		Mechanical	
10G Ethernet	2x 10GBASE-T ports by Intel® X550-AT2, supporting NBASE-T (5G/ 2.5G)	Dimension	444.4 mm (W) x 350 mm (D) x 88.1 mm (H)
Gigabit Ethernet	4x GbE ports by Intel I350-AM4	Weight	8.6 kg (incl. CPU & RDIMM)
PoE+	IEEE 802.3at PoE+ PSE capability on 4x GbE ports	Mounting	Wall-mount with damping brackets (standard) Rack-mount (optional)
Video Port	1x VGA port via ASPEED AST2500 BMC	Environmental	
USB	4x USB 3.1 Gen1 (5 Gbps) ports	Operating Temperature	-25°C ~ 60°C with 100% CPU/ GPU loading **/**
Serial Port	2x software-programmable RS-232/ 422/ 485 ports	Storage Temperature	-40°C ~ 85°C
Storage Interface		Humidity	10%~90% , non-condensing
SATA	4x easy-swappable HDD trays for 2.5" HDD/ SSD installation	Vibration	Operating, MIL-STD-810G, Method 514.6, Category 4
M.2	1x M.2 2280 M key socket (PCIe Gen4 x4) for NVMe SSD	Shock	Operating, MIL-STD-810G, Method 516.6, Procedure I, Table 516.6-II
Expansion Bus		EMC	CE/ FCC Class A, according to EN 55032 & EN 55035
PCI Express	1x PCIe x16 slot@Gen4, 16-lanes for RTX A6000/ A4500 installation 2x PCIe x16 slots@Gen4, 8-lanes		

* The CPU and GPU loading tests are applied using Passmark® BurnInTest 9.1 with a 225W CPU. Operating temperature degrades with higher CPU TDP. For detailed testing criteria, please contact Neousys Technology.
** For sub-zero operating temperature, a wide temperature HDD drive or Solid State Disk (SSD) is required.

Appearance

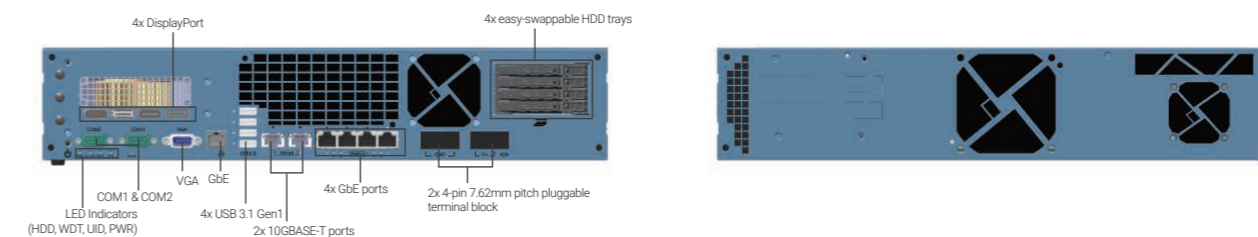

Dimensions



Unit : mm

Ordering Information

Model No.	Product Description
RGS-8805GC	AMD® EPYC™ 7003 "MILAN" series rugged HPC server supporting NVIDIA® RTX A6000/ A4500 GPU, 2x 10G and 4x 1G Ethernet and 8 to 48V DC input

Optional Accessories

PA-600W-ENC	600W AC/DC power adapter 24V/25A; cord end terminals for terminal block, operating temperature : -20°C to 70°C.
-------------	---

Nuvo-10208GC Series

Industrial-grade Edge AI Platform Supporting Dual NVIDIA® RTX series 350W GPU Cards, Intel® 13th /12th-Gen Core™ Processor with 3x Additional PCIe Slots and 10G/2.5G/1G Ethernet Ports

Key Features

- Supports dual NVIDIA RTX™ series 350W GPUs with patent-pending locking mechanism
- Intel® 13th/12th-Gen Core™ 35W/ 65W LGA1700 CPU
- Up to 64GB DDR5 4800 with Intel R680E PCH (2x SODIMM)
- Three x8, Gen3 PCIe slots (x4 signal) for add-on cards
- 2x 2.5GbE and 1x GbE and 1x optional 10GBASE-T Ethernet
- 1x internal M.2 NVMe, 2x 2.5" SATA trays and 1x optional NVMe tray
- Support 8 to 48V wide-range DC input with ignition power control
- Rugged, -25°C to 60°C operation



CE FC

Preliminary

Introduction

Nuvo-10208GC is an Intel® 13th/ 12th-Gen rugged edge AI platform supporting dual RTX 40 series/ RTX A6000/A4500 GPU cards to offer GPU performances up to 97 TFLOPS in FP32 for autonomous driving, vision inspection and surveillance applications.

Powered by Intel® 13th/ 12th-Gen CPU with up to 24 cores and 32 threads, Nuvo-10208GC offers up to twice the performance when compared to previous Intel 10th or 11th Gen platforms. It inherits proven thermal dissipation design for the CPU and two 350W GPUs to optimize overall system performance in harsh temperature conditions. To secure the bigger and heavier NVIDIA® RTX™ 40 series GPU, Nuvo-10208GC features innovative, patent-pending GPU locking brackets to fasten GPUs to the chassis. It also features Neousys' patented damping bracket to guarantee rock-solid reliability for on-road and off-road in-vehicle applications.

Nuvo-10208GC also incorporates an abundance of I/Os such as 3x 2.5GbE/GbE, 6x USB3.2 Gen2, 1x M.2 M key 2280 Gen4x4 NVMe, dual SATA trays with RAID 0/1 capability, dual display ports and three additional PCIe slots for function expansion. Moreover, it's equipped with one optional 10G Ethernet port for high-bandwidth data transmission, and one optional M.2 2280 NVMe tray for high-speed, removable data storage.

Utilizing Intel's 13th/ 12th-Gen platform, proven thermal and rugged mechanical designs with rich I/O interfaces, Nuvo-10208GC is a ruggedized edge AI platform that offers unprecedented GPU and CPU computing power for various industrial edge AI applications.

Specifications

System Core		Expansion Bus
Processor	Supporting Intel® 13th-Gen Core™ CPU (LGA1700 socket, 65W/ 35W TDP)	PCI Express 2x PCIe x16 slot@Gen4, 8-lanes 3x PCIe x8 slot@Gen3, 4-lanes
	Supporting Intel® 12th-Gen Core™ CPU (LGA1700 socket, 65W/ 35W TDP)	mini-PCIe 2x full-size mini PCI Express sockets with internal SIM sockets
Chipset	- Intel® Core™ i9-13900E/ i9-13900TE	M.2 1x M.2 2242/3052 B key socket with internal SIM sockets
	- Intel® Core™ i7-13700E/ i7-13700TE	
Graphics	- Intel® Core™ i5-13500E/ i5-13400E/ i5-13500TE	Power Supply
Memory	- Intel® Core™ i3-13100E/ i3-13100TE	DC Input 3-pin+ 4-pin pluggable terminal block for 8~48V DC input with ignition control
AMT	- Intel® Pentium® G7400E/ G7400TE	Mechanical
TPM	- Intel® Celeron® G6900E/ G6900TE	Dimension 268 mm (W) x 400 mm (D) x 196 mm (H)
Intel® R680E Platform Controller Hub		Weight 6.5 Kg
Integrated Intel® UHD Graphics 770 (32EU) / 730 (24EU)		Mounting Wall-mount with damping brackets
Up to 64GB ECC/ non-ECC DDR5 4800 SDRAM (two SODIMM slots)		Environmental
Supports Intel vPro/ AMT 16.0		Operating Temperature With 35W CPU and dual NVIDIA® 350W GPU -25°C to 60°C * with 65W CPU and dual NVIDIA® 350W GPU -25°C ~ 60°C **/ (with optional fan kit) -25°C ~ 50°C **/ (without optional fan kit)
Supports dTPM 2.0		Storage Temperature -40°C ~ 85°C
I/O Interface		Humidity 10%~90% , non-condensing
Ethernet	2x 2.5G Ethernet by I226-IT and 1x Gigabit Ethernet by I219-LM	Vibration MIL-STD-810H, Method 514.8, Category 4
10G Ethernet	Optional 1x 10GBASE-T port by Marvell AQc113CS, supporting NBASE-T (5G/ 2.5G) and 1000BASE-T	Shock MIL-STD-810H, Method 516.8, Procedure I
USB 3.2	6x USB 3.2 Gen2x1 (10 Gbps) ports	EMC CE/ FCC Class A, according to EN 55032 & EN 55035
USB 2.0	1x USB 2.0 ports (internal for dongle use)	
Serial Port	2x software-programmable RS-232/ 422/ 485 ports (COM1/ COM2)	
Video Port (Integrated Graphics)	1x VGA output, supporting 1920 x 1200 resolution 1x DisplayPort, supporting 4096 x 2304 resolution	
Audio	1x 3.5 mm jack for mic-in and speaker-out	
Storage Interface		
SATA HDD	2x hot-swappable HDD trays for 2.5" HDD/ SSD installation (support RAID 0/ 1)	
M.2	1x M.2 2280 M key socket (PCIe Gen4 x4) for NVMe SSD Optional 1x M.2 2280 M key tray (PCIe Gen4 x4) for NVMe SSD	

* For sub-zero operating temperature, a wide temperature HDD or Solid State Disk (SSD) is required.
** For 65W CPUs, the optional fan kit is recommended for operating at ambient temperatures higher than 50°C.

Appearance

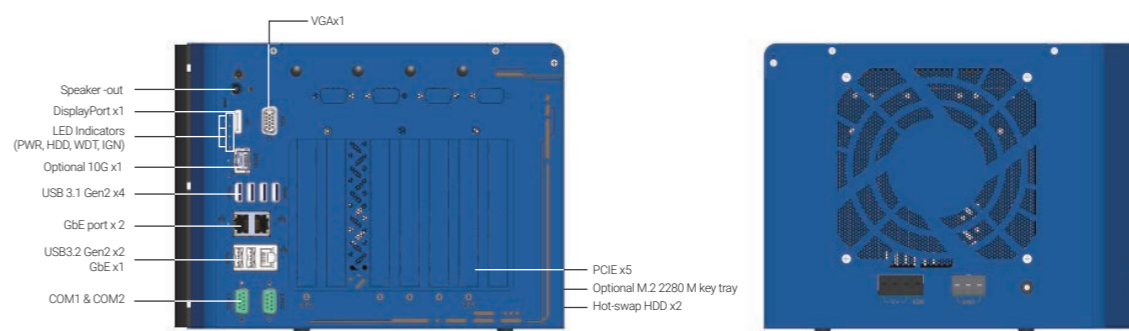

Dimensions

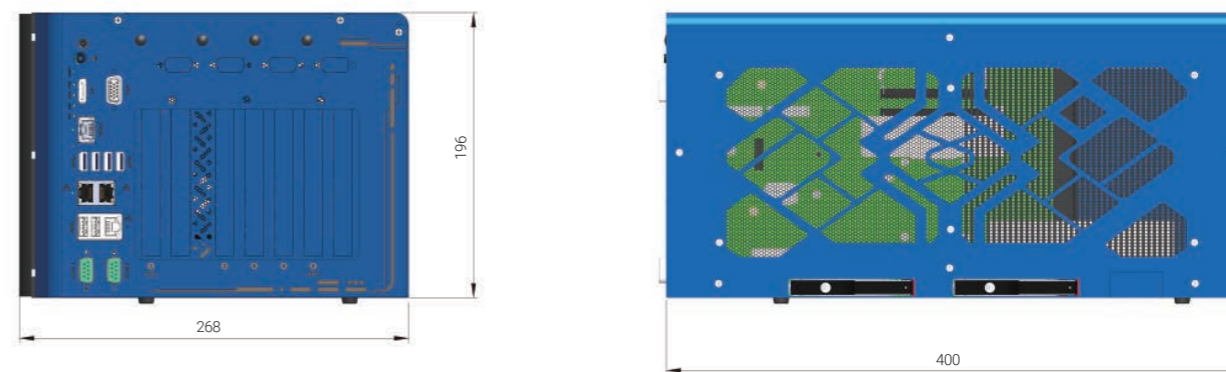

Ordering Information

Model No.	Product Description
Nuvo-10208GC	Industrial-grade Edge AI Platform supporting dual NVIDIA® RTX series 350W GPU Cards, Intel® 13th/12th-Gen Core™ processor with 3x additional PCIe slots
	Optional 10GbE and M.2 2280 M key tray (PCIe Gen4 x4)

Optional Accessories

AccsyBx-FAN-Nuvo10208GC	Fan assembly for Nuvo-10208GC series, 92x92x25 mm
TY-NVMe- Nuvo10208GC	M.2 NVMe 2230/42/60/80 SSD Tray
PA-600W-ENC	600W AC/DC power adapter 24V/25A; cord end terminals for terminal block, operating temperature : -20°C to 70°C.

Nuvo-8208GC

Industrial-grade GPU Computing Platform Supporting Dual 250W NVIDIA® Graphics Card, Intel® Xeon® E or 9th/ 8th-Gen Core™ Processor

Key Features

- Supports dual 250W NVIDIA® graphics cards up to 28 TFLOPS in FP32
- Supports Intel® Xeon® E or 9th/8th-Gen Core™ i7/ i5 LGA1151 CPU
- Up to 128GB ECC/ non-ECC DDR4 2133 (4x SODIMM)
- Two x8 (4-lanes), one x4(1-lane), Gen3 PCIe slots for add-on cards
- Two hot-swappable 2.5" SATA HDD/ SSD with RAID 0/ 1 support
- 8 to 35V wide-range DC input with built-in ignition power control
- Patented thermal design for -25°C to 60°C rugged operation*
- Patented damping brackets* to withstand 3 Grms vibration



CE FC

*R.O.C Patent No. M534371 / M491752

Introduction

Nuvo-8208GC is the world's first dual GPU platform with industrial-grade design and in-vehicle features. Designed specifically to support two high-end 250W NVIDIA® graphics cards, it offers tremendous GPU power up to 28 TFLOPS in FP32 for emerging GPU-accelerated edge computing, such as autonomous driving, vision inspection and surveillance/ security.

Nuvo-8208GC is powered by Intel® Xeon® E or 9th/ 8th-Gen Core™ 8-core/ 16-thread CPUs coupled with workstation-grade Intel® C246 chipset to support up to 128 GB ECC or non-ECC DDR4 memory. The system incorporates two hot-swappable 2.5" trays for easy HDD/ SSD replacement and an M.2 2280 NVMe socket for the ultimate disk performance. Its front-accessible GbE and USB 3.1 Gen1/ Gen2 ports feature screw-lock mechanisms for securing cable connections. In addition to the dual x16 PCIe slots for GPU installation, Nuvo-8208GC has two other x8 PCIe slots and one x4 PCIe slot for expansion cards to extend function sets like data collection, analytics and communication.

Nuvo-8208GC has a brand new power delivery design to accept 8 to 35V wide-range DC input and to handle heavy power requirements from dual 250W GPUs. Along with built-in ignition control, it's feasible to deploy it on a vehicle and directly power it via the car's power system. Mechanical wise, Nuvo-8208GC incorporates Neosys' patented heat dissipation design*, damping brackets* and patented GPU press bar**, making it steady and rock-solid in various conditions.

The Nuvo-8208GC is Neosys' response to the never-ending demand of TFLOPS in industrial GPU platforms. With industrial-grade power, thermal and mechanical design, it pushes versatile AI inference applications from laboratories to field applications, where reliability matters.

*R.O.C Patent No. I687801

Specifications

System Core		Expansion Bus	
Processor	Supporting Intel® Xeon® E and 9th/ 8th-Gen CPU (LGA1151 socket) - Xeon E 2176G/ 2278GE (8C/16T) / 2278GEL (8C/16T) - i7-9700E, i7-9700TE, i7-8700, i7-8700T - i5-9500E, i5-9500TE, i5-8500, i5-8500T - i3-9100E, i3-9100TE, i3-8100, i3-8100T	PCI Express	2x PCIe x16 slot@Gen3, 8-lanes 2x PCIe x8 slots@Gen3, 4-lanes 1x PCIe x4 slot@Gen3, 1-lane
Chipset	Intel® C246 platform controller hub	M.2	1x M.2 2242 B key socket supporting dual SIM mode with selected M.2 LTE module
Graphics	Independent GPU via x16 PEG port, or integrated Intel® UHD Graphics 630	mini-PCIe	2x full-size mini PCI Express socket
Memory	Up to 128 GB ECC/ non-ECC DDR4 2133 SDRAM (four SODIMM slots)	Power Supply	
AMT	Supports AMT 12.0	DC Input	2x 4-pin pluggable terminal block for 8 to 35V DC input with ignition control [1]
TPM	Supports TPM 2.0	Mechanical	
I/O Interface		Dimension	225 mm (W) x 360 mm (D) x 186 mm (H)
Ethernet	1x Gigabit Ethernet port by Intel® I219-LM 1x Gigabit Ethernet port by Intel® I210-IT	Weight	8.6 Kg
Video Port	1x VGA , supporting 1920 x 1200 resolution 1x DVI-D, supporting 1920 x 1200 resolution 1x DisplayPort, supporting 4096 x 2304 resolution	Mounting	Wall-mount with damping brackets
Serial Port	2x software-programmable RS-232/ 422/ 485 ports (COM1/ COM2)	Environmental	
USB3.1	4x USB 3.1 Gen2 (10 Gbps) ports 4x USB 3.1 Gen1 (5 Gbps) ports	Operating Temperature	with 35W CPU and dual NVIDIA® 250W GPU -25°C ~ 60°C [2] with >= 65W CPU and dual NVIDIA® 250W GPU -25°C ~ 60°C [2][3] (configured as 35W TDP mode) -25°C ~ 50°C [2][3] (configured as 65W TDP mode)
USB 2.0	1x USB 2.0 port (internal for dongle use)	Storage Temperature	-40°C ~ 85°C
Audio	1x 3.5 mm jack for mic-in and speaker-out	Humidity	10%~90% , non-condensing
Storage Interface		Vibration	Operating, MIL-STD-810G, Method 514.6, Category 4; and 3 Grms, 5-500 Hz, 3 Axes
SATA	2x hot-swappable HDD trays for 2.5" HDD/ SSD installation	Shock	Operating, MIL-STD-810G, Method 516.6, Procedure I, Table 516.6-II
M.2	1x M.2 2280 M key socket (PCIe Gen3 x4) for NVMe SSD or Intel® Optane™ memory installation	EMC	CE/ FCC Class A, according to EN 55024 & EN 55032
mSATA	2x full-size mSATA port (mux with mini-PCIe)		

[1] System load under 100W, the required DC input range is 8V to 35V
System load between 100W to 480W (single GPU), the required DC input range is 18V to 35V
System load between 480W 1000W (dual GPUs), the required DC input is 24V to 35V

[2] For i7-9700E and i7-8700 running at 65W mode, the highest operating temperature shall be limited to 50°C and thermal throttling may occur when sustained full-loading applied. Users can configure CPU power in BIOS to obtain higher operating temperature.

[3] For sub-zero operating temperature, a wide temperature HDD or Solid State Disk (SSD) is required.

Appearance

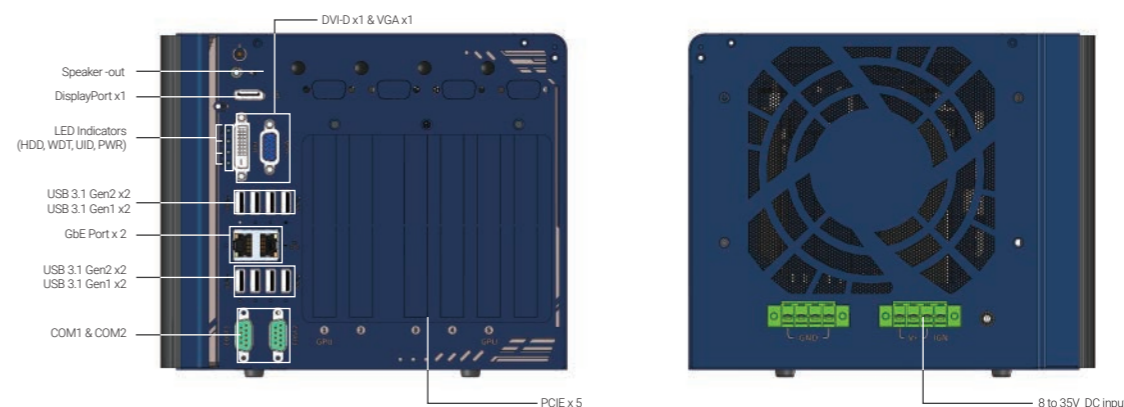

Dimensions

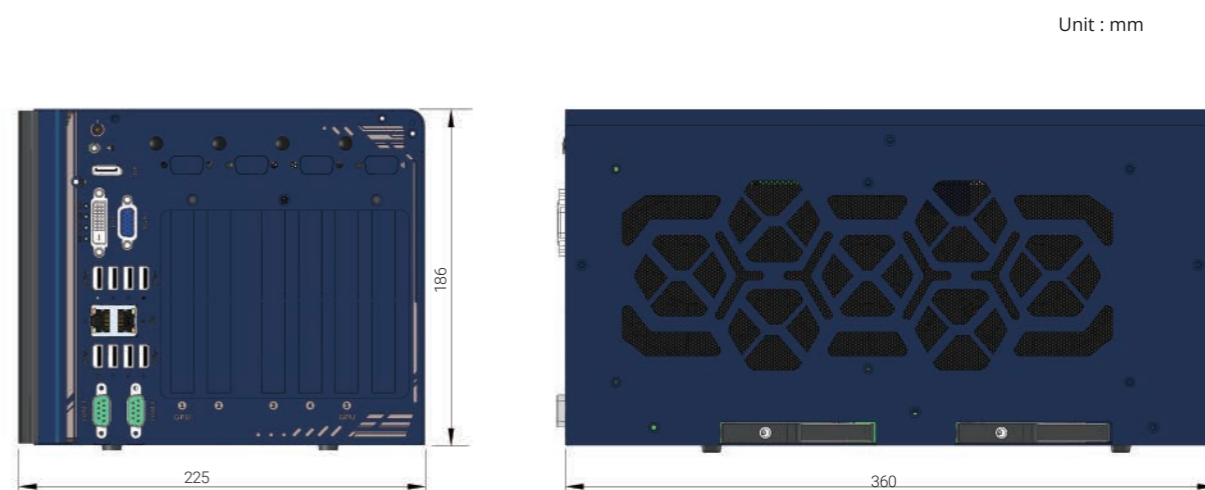

Ordering Information

Model No.	Product Description
Nuvo-8208GC	Industrial-grade GPU computing platform supporting dual 250W NVIDIA® graphics cards, Intel® Xeon® E or 9th/ 8th-Gen Core™ processor with 8 to 35V DC input and ignition control

Optional Accessories

PA-480W-DIN	480W AC-DC power Adapter(SDR-480-24) DIN-rail mount, 24V 20A, 90~264VAC/127~370VDC, Terminal Block, -20~+70°C, Meanwell SDR-480-24
-------------	--

Nuvo-8108GC-XL

Industrial-grade Edge AI Platform Supporting NVIDIA® RTX 30 series GPU Card, Intel® Xeon® E and 9th/ 8th-Gen Core™ Processor, 8~48V wide-range DC Input and Built-in Ignition Control



Key Features

- Supports an NVIDIA® RTX 30 series graphics card up to RTX 3080
- Supports Intel® Xeon® E or 9th/ 8th-Gen Core™ i7/ i5 LGA1151 CPU
- Up to 128GB ECC/ non-ECC DDR4 2133 (4x SODIMM)
- 2x PCIe x16 slot@Gen3, 8-lanes, 2x PCIe x8 slots@Gen3, 4-lanes
- 2x M.2 B key and 2x full-size mini-PCIe sockets
- 8~48V wide-range DC input with built-in ignition power control
- Patented thermal design for -25°C to 60°C rugged operation*
- Patented damping brackets* to withstand 3 Grms vibration



*R.O.C Patent No. M534371 / M491752

Introduction

Nuvo-8108GC-XL is one of the first rugged edge AI platforms to support an NVIDIA® RTX 30 series graphics card up to RTX 3080. Together, the system offers tremendous GPU power up to 29.8 TFLOPS in FP32 to take GPU-accelerated edge computing such as autonomous driving, vision inspection and intelligent video analytics to the next level.

Powered by an Intel® Xeon® E or 9th/ 8th-Gen Core™ (up to 8-core/ 16-thread) CPU with workstation-grade Intel® C246 chipset to support up to 128 GB ECC or non-ECC DDR4 memory, the system is a strong foundation to build a powerful AI edge computing platform on. Featuring a brand new mechanical design that is optimized to bring out the best in the latest RTX 30 series GPU cards and its parallel operation of heterogeneous computing architecture. In addition to the x16 PCIe slot (8-lanes) for RTX 30 series GPU installation, Nuvo-8108GC-XL has other one x8 PCIe slots (4-lanes) and one x16 PCIe slot (8-lanes) for users to add on high performance or bandwidth-hungry expansion cards to extend function sets, such as data collection, analytics and communication.

Nuvo-8108GC-XL incorporates Neosys' patented heat dissipation design*, damping brackets* and enhanced GPU stabilizing bar, steadying it for reliable and rock-solid operation in shock or vibration conditions. Continuing the heritage of Neosys' proven power and thermal design, the Nuvo-8108GC-XL accepts 8~48V wide-range DC input to handle heavy power requirements from RTX 30 series GPU under wide temperature operation. Incorporating the built-in ignition control, it can be deployed on a vehicle and directly power it via the car's power system.

Nuvo-8108GC-XL is Neosys' response to the never-ending demand for TFLOPS performance in industrial GPU platforms. With proven industrial-grade power, guaranteed thermal performance, and new mechanical design, it takes edge AI computing to the next level.

Specifications

System Core		Expansion Bus	
Processor	Supporting Intel® Xeon® E and 9th/ 8th-Gen CPU (LGA1151 socket) - Xeon E 2176G/ 2278GE (8C/16T) / 2278GEL (8C/16T) - i7-9700E, i7-9700TE, i7-8700, i7-8700T - i5-9500E, i5-9500TE, i5-8500, i5-8500T - i3-9100E, i3-9100TE, i3-8100, i3-8100T	PCI Express™	2x PCIe x16 slot@Gen3, 8-lanes 2x PCIe x8 slots@Gen3, 4-lanes
Chipset	Intel® C246 Platform Controller Hub	M.2	1x M.2 2242 B key socket supporting dual SIM mode with selected M.2 LTE module
Graphics	Independent GPU via x16 PEG port, or integrated Intel® UHD Graphics 630	Mini-PCIe	2x full-size mini PCI Express socket
Memory	Up to 128 GB ECC/ non-ECC DDR4 2133 SDRAM (four SODIMM slots)	Power Supply	
AMT	Supports AMT 12.0	DC Input	2x 4-pin pluggable terminal block for 8 to 48V DC input with ignition control ^[1]
TPM	Supports TPM 2.0	Mechanical	
I/O Interface		Dimension	193 mm (W) x 388 mm (D) x 198 mm (H)
Ethernet	1x Gigabit Ethernet port by Intel® I219-LM 1x Gigabit Ethernet port by Intel® I210-IT	Weight	5.2 kg
Video Port	1x VGA, supporting 1920 x 1200 resolution 1x DVI-D, supporting 1920 x 1200 resolution 1x DisplayPort, supporting 4096 x 2304 resolution	Mounting	Wall-mount with damping brackets
Serial Port	2x software-programmable RS-232/ 422/ 485 ports (COM1/ COM2)	Environmental	
USB 3.1	4x USB 3.1 Gen2 (10 Gbps) ports 4x USB 3.1 Gen1 (5 Gbps) ports	Operating Temperature	with 35W CPU and one NVIDIA® RTX 30 Series GPU -25°C ~ 60°C ^[4] with >= 65W CPU and one NVIDIA® RTX 30 Series GPU -25°C ~ 60°C ^[3] (configured as 35W TDP mode) -25°C ~ 50°C ^[3] (configured as 65W TDP mode)
USB 2.0	1x USB 2.0 ports (internal for dongle use)	Storage Temperature	-40°C ~ 85°C
Audio	1x 3.5 mm jack for mic-in and speaker-out	Humidity	10%~90%, non-condensing
Storage Interface		Vibration	Operating, MIL-STD-810G, Method 514.6, Category 4; and 3 Grms, 5-500 Hz, 3 Axes
SATA	1x hot-swappable HDD tray for 2.5" HDD/ SSD installation 1x Internal SATA port for 2.5" HDD/ SSD installation, supporting RAID 0/ 1	Shock	Operating, MIL-STD-810G, Method 516.6, Procedure I, Table 516.6-II
M.2	1x M.2 2280 M key socket (PCIe Gen3 x4) for NVMe SSD or Intel® Optane™ memory installation	EMC	CE/ FCC Class A, according to EN 55024 & EN 55032
mSATA	2x full-size mSATA port (mux with mini-PCIe)		

[1] System load under 100W, the required DC input range is 8V to 48V

System load between 100W to 480W (single GPU), the required DC input range is 18V to 48V

[2] Note: With an RTX graphics card installed, a PCIe x8 slot may be blocked and rendered unusable.

[3] For i7-8700 running at 65W mode, the highest operating temperature shall be limited to 50°C and thermal throttling may occur when sustained full-loading applied. Users can configure CPU power in BIOS to obtain higher operating temperature.

[4] For sub-zero operating temperature, a wide temperature HDD or Solid State Disk (SSD) is required.

Appearance



Dimensions

Unit : mm

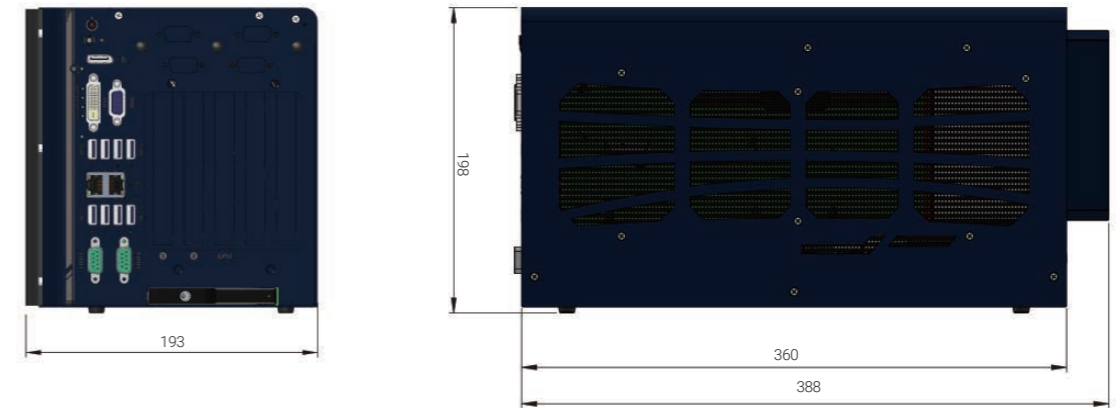

Ordering Information

Model No.	Product Description
Nuvo-8108GC-XL	Industrial-grade edge AI platform supporting NVIDIA® RTX 30 series GPU Card, Intel® Xeon® E and 9th/ 8th-Gen Core™ processor with 8~48V wide-range DC input and built-in ignition control

Optional Accessories

PA-480W-DIN	480W AC-DC power Adapter(SDR-480-24) DIN-rail mount, 24V 20A, 90~264VAC/127~370VDC, Terminal Block, -20~+70°C, Meanwell SDR-480-24
--------------------	--

Nuvo-8108GC-QD

Industrial-grade Edge AI Platform Supporting NVIDIA® RTX A6000/ A4500 GPU, Intel® Xeon® E and 9th/ 8th-Gen Core™ Processor



Key Features

- Supports NVIDIA® RTX A6000/ A4500 GPU cards
- Supports Intel® Xeon® E or 9th/ 8th-Gen Core™ i7/ i5 LGA1151 CPU
- Up to 128GB ECC/ non-ECC DDR4 2133 (4x SODIMM)
- One x16 (8-lanes), one x8 (4-lanes), Gen3 PCIe slots for add-on cards
- Dedicated GPU card bracket
- 8~48V wide-range DC input with built-in ignition power control
- Patented thermal design for -25°C to 60°C rugged operation*
- Patented damping brackets* to withstand 3 Grms vibration

CE FC

*R.O.C Patent No. M534371 / M491752

Introduction

Nuvo-8108GC-QD, the latest member of the well-received Nuvo-8108GC series, is a rugged edge AI platform specially designed for NVIDIA® RTX A6000 and RTX A4500 Ampere GPU cards. The GPUs offer tremendous computing power and product longevity, to take GPU-accelerated edge AI applications such as autonomous driving, vision inspection and intelligent video analytics to the next level of reliability and availability.

Powered by an Intel® Xeon® E or 9th/ 8th-Gen Core™ (up to 8-core/ 16-thread) CPU with workstation-grade Intel® C246 chipset to support up to 128 GB ECC or non-ECC DDR4 memory, it has a strong foundation for building a powerful AI edge computing platform. It has a refined thermal dissipation design to optimize GPU performance in high-temperature environments. Additionally, Nuvo-8108GC-QD comes with a dedicated mounting bracket for RTX A6000/ A4500 to keep the GPU card firmly secured in the PCIe slot. Along with Neosys' patented damping brackets*, it ensures rock-solid operation in intensive shock and vibration conditions.

The addition of RTX A6000/ A4500 to Neosys' GPU computer portfolio realizes an edge AI platform with system-level longevity and up to 28 TFLOPS computing power. Combining proven power design, guaranteed thermal performance, and superior mechanical ruggedness, Nuvo-8108GC-QD brings unprecedented longevity, computing power, flexibility and reliability to edge AI computing.

Specifications

System Core		Expansion Bus	
Processor	Supporting Intel® Xeon® E and 9th/ 8th-Gen CPU (LGA1151 socket)	PCI Express	2x PCIe x16 slot@Gen3, 8-lanes
	- Xeon E 2176G/ 2278GE (8C/16T) / 2278GEL (8C/16T)		2x PCIe x8 slots@Gen3, 4-lanes
	- i7-9700E, i7-9700TE, i7-8700, i7-8700T	M.2	1x M.2 2242 B key socket supporting dual SIM mode with selected M.2 LTE module
	- i5-9500E, i5-9500TE, i5-8500, i5-8500T		2x full-size mini PCI Express socket
- i3-9100E, i3-9100TE, i3-8100, i3-8100T	Power Supply		
Chipset	Intel® C246 Platform Controller Hub	DC Input	2x 4-pin pluggable terminal block for 8 to 48V DC input with ignition control [1]
Graphics	Independent NVIDIA® RTX A6000/ A4500 GPU via x16 PEG port, or integrated Intel® UHD graphics 630	Mechanical	
Memory	Up to 128 GB ECC/ non-ECC DDR4 2133 SDRAM (four SODIMM slots)	Dimension	170.2 mm (W) x 360 mm (D) x 201.8 mm (H)
AMT	Supports AMT 12.0	Weight	5.8 kg
TPM	Supports TPM 2.0	Mounting	Neosys' patented damping brackets
I/O Interface		Environmental	
Ethernet	1x Gigabit Ethernet port by Intel® I219-LM 1x Gigabit Ethernet port by Intel® I210-IT	Operating Temperature	with 35W CPU and one NVIDIA® RTX A6000/ A4500 GPU -25°C ~ 60°C [2]
Video Port	1x VGA , supporting 1920 x 1200 resolution 1x DVI-D, supporting 1920 x 1200 resolution 1x DisplayPort, supporting 4096 x 2304 resolution		with >= 65W CPU and one NVIDIA® RTX A6000/ A4500 GPU -25°C ~ 60°C [2][3] (configured as 35W TDP mode)
Serial Port	2x software-programmable RS-232/ 422/ 485 ports (COM1/ COM2)		-25°C ~ 50°C [2][3] (configured as 65W TDP mode)
USB 3.1	4x USB 3.1 Gen2 (10 Gbps) ports 4x USB 3.1 Gen1 (5 Gbps) ports	Storage Temperature	-40°C ~ 85°C
USB 2.0	1x USB 2.0 ports (internal for dongle use)	Humidity	10%~90% , non-condensing
Audio	1x 3.5 mm jack for mic-in and speaker-out	Vibration	Operating, MIL-STD-810G, Method 514.6, Category 4
Storage Interface		Shock	Operating, MIL-STD-810G, Method 516.6, Procedure I, Table 516.6-II
SATA	1x hot-swappable HDD tray for 2.5" HDD/ SSD installation 1x Internal SATA port for 2.5" HDD/ SSD installation, supporting RAID 0/ 1	EMC	CE/ FCC Class A, according to EN 55024 & EN 55032
M.2	1x M.2 2280 M key socket (PCIe Gen3 x4) for NVMe SSD or Intel® Optane™ memory installation	Footnotes:	
mSATA	2x full-size mSATA port (mux with mini-PCIe)	[1] System load under 100W, the required DC input range is 8V to 48V System load between 100W to 480W (single GPU), the required DC input range is 18V to 48V [2] For i7-9700/ 8700 running at 65W mode, the highest operating temperature shall be limited to 50°C and thermal throttling may occur when sustained full-loading is applied. Users can configure CPU power in the BIOS to obtain higher operating temperatures. [3] For sub-zero operating temperature, a wide temperature HDD or Solid State Disk (SSD) is required.	

Appearance

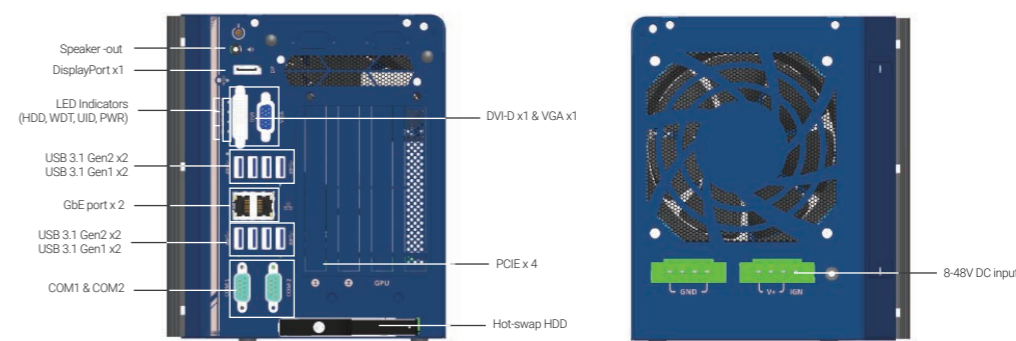

Dimensions

Unit : mm

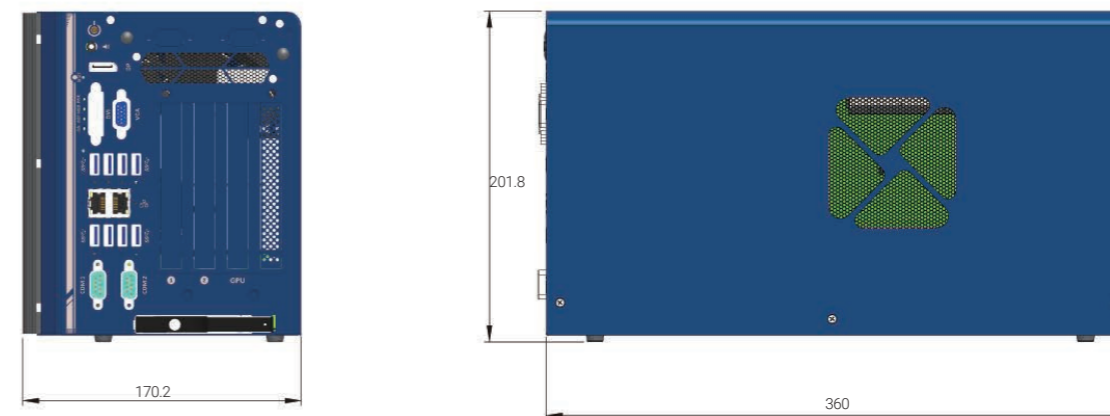

Ordering Information

Model No.	Product Description
Nuvo-8108GC-QD	Industrial-grade edge AI platform supporting NVIDIA® RTX A6000/ A4500 GPU, Intel® Xeon® E and 9th/ 8th-Gen Core™ processor with 8-48V wide-range DC input and built-in ignition control

Optional Accessories

PA-480W-DIN	480W AC-DC power Adapter(SDR-480-24) DIN-rail mount, 24V 20A, 90~264VAC/127~370VDC, Terminal Block, -20~+70°C, Meanwell SDR-480-24
PA-600W-ENC	600W AC/DC power adapter 24V/25A; cord end terminals for terminal block, operating temperature : -20°C to 70°C.

Nuvo-8108GC

Industrial-grade GPU Computing Edge AI Platform Supporting an NVIDIA® RTX 30 Series Graphics Card, Intel® Xeon® E or 9th/ 8th-Gen Core™ Processor

Key Features

- Supports an NVIDIA® RTX 30 Series graphic card
- Supports Intel® Xeon® E or 9th/ 8th-Gen Core™ i7/ i5 LGA1151 CPU
- Up to 128GB ECC/ non-ECC DDR4 2133 (4x SODIMM)
- 2x PCIe x16 slot@Gen3, 8-lanes, 2x PCIe x8 slots@Gen3, 4-lanes
- 1x M.2 M key, 1x M.2 B key and 2x full-size mini-PCIe sockets
- 8 to 48V wide-range DC input with built-in ignition power control
- Patented thermal design for -25°C to 60°C rugged operation*
- Patented damping brackets* to withstand 3 Grms vibration



CE FC

*R.O.C Patent No. M534371 / M491752

Introduction

Nuvo-8108GC is a rugged edge AI platform with industrial-grade design and in-vehicle features. Designed specifically to support a high-end 250W NVIDIA® graphics card, it offers tremendous GPU power up to 14 TFLOPS in FP32 for emerging GPU-accelerated edge computing, such as autonomous driving, vision inspection and surveillance/ security.

Nuvo-8108GC is powered by Intel® Xeon® E or 9th/ 8th-Gen Core™ (up to 8-core/ 16-thread) CPUs coupled with workstation-grade Intel® C246 chipset to support up to 128 GB ECC or non-ECC DDR4 memory. The system incorporates an internal 2.5" HDD/ SSD tray and one hot-swappable 2.5" HDD/ SSD tray for easy replacement. There is also an M.2 2280 NVMe socket for the fast read/ write performance. Its front-accessible GbE and USB 3.1 Gen1/ Gen2 ports feature screw-lock mechanisms for securing cable connections. In addition to the x16 PCIe slot (8-lanes) for GPU installation, Nuvo-8108GC has other two x8 PCIe slots (4-lanes) and one x16 PCIe slot (8-lanes) for expansion cards to extend function sets like data collection, analytics and communication.

Nuvo-8108GC has a brand new power delivery design to accept 8 to 48V wide-range DC input and to handle heavy power requirements from 250W GPU. Along with built-in ignition control, it's feasible to deploy it on a vehicle and directly power it via the car's power system. Mechanical wise, Nuvo-8108GC incorporates Neosys' patented heat dissipation design*, damping brackets* and patent-pending GPU press bar, making it steady and rock-solid in various conditions. The Nuvo-8108GC is Neosys' response to the never-ending demand of TFLOPS in industrial GPU platforms. With industrial-grade power, thermal and mechanical design, it pushes versatile AI inference applications from laboratories to field applications, where reliability matters.

Specifications

System Core		Expansion Bus	
Processor	Supporting Intel® Xeon® E and 9th/ 8th-Gen CPU (LGA1151 socket) - Xeon E 2176G/ 2278GE (8C/16T) / 2278GEL (8C/16T) - i7-9700E, i7-9700TE, i7-8700, i7-8700T - i5-9500E, i5-9500TE, i5-8500, i5-8500T - i3-9100E, i3-9100TE, i3-8100, i3-8100T	PCI Express	2x PCIe x16 slot@Gen3, 8-lanes 2x PCIe x8 slots@Gen3, 4-lanes
Chipset	Intel® C246 Platform Controller Hub	M.2	1x M.2 2242 B key socket supporting dual SIM mode with selected M.2 LTE module
Graphics	Independent GPU via x16 PEG port, or integrated Intel® UHD Graphics 630	Mini-PCIe	2x full-size mini PCI Express socket
Memory	Up to 128 GB ECC/ non-ECC DDR4 2133 SDRAM (four SODIMM slots)	Power Supply	
AMT	Supports AMT 12.0	DC Input	2x 4-pin pluggable terminal block for 8 to 48V DC input with ignition control ^[1]
TPM	Supports TPM 2.0	Mechanical	
I/O Interface		Dimension	170 mm (W) x 360 mm (D) x 198 mm (H)
Ethernet	1x Gigabit Ethernet port by Intel® I219-LM 1x Gigabit Ethernet port by Intel® I210-IT	Weight	5 kg
Video Port	1x VGA, supporting 1920 x 1200 resolution 1x DVI-D, supporting 1920 x 1200 resolution 1x DisplayPort, supporting 4096 x 2304 resolution	Mounting	Neosys' patented damping brackets
Serial Port	2x software-programmable RS-232/ 422/ 485 ports(COM1/ COM2)	Environmental	
USB 3.1	4x USB 3.1 Gen2 (10 Gbps) ports 4x USB 3.1 Gen1 (5 Gbps) ports	Operating Temperature	with 35W CPU and one NVIDIA® 250W GPU -25°C ~ 60°C ^[2] with >= 65W CPU and one NVIDIA® 250W GPU -25°C ~ 60°C ^{[2]/[3]} (configured as 35W TDP mode) -25°C ~ 50°C ^{[2]/[3]} (configured as 65W TDP mode)
USB 2.0	1x USB 2.0 ports (internal for dongle use)	Storage Temperature	-40°C ~ 85°C
Audio	1x 3.5 mm jack for mic-in and speaker-out	Humidity	10%~90%, non-condensing
Storage Interface		Vibration	Operating, MIL-STD-810G, Method 514.6, Category 4; and 3 Grms, 5-500 Hz, 3 Axes
SATA	1x hot-swappable HDD tray for 2.5" HDD/ SSD installation 1x Internal SATA port for 2.5" HDD/ SSD installation, supporting RAID 0/ 1	Shock	Operating, MIL-STD-810G, Method 516.6, Procedure I, Table 516.6-II
M.2	1x M.2 2280 M key socket (PCIe Gen3 x4) for NVMe SSD or Intel® Optane™ memory installation	EMC	CE/ FCC Class A, according to EN 55024 & EN 55032
mSATA	2x full-size mSATA port (mux with mini-PCIe)		

[1] System load under 100W, the required DC input range is 8V to 48V
System load between 100W to 480W (single GPU), the required DC input range is 18V to 48V
[2] For i7-9700/ 8700 running at 65W mode, the highest operating temperature shall be limited to 50°C and thermal throttling may occur when sustained full-loading is applied. Users can configure CPU power in the BIOS to obtain higher operating temperatures.
[3] For sub-zero operating temperature, a wide temperature HDD or Solid State Disk (SSD) is required.

Appearance

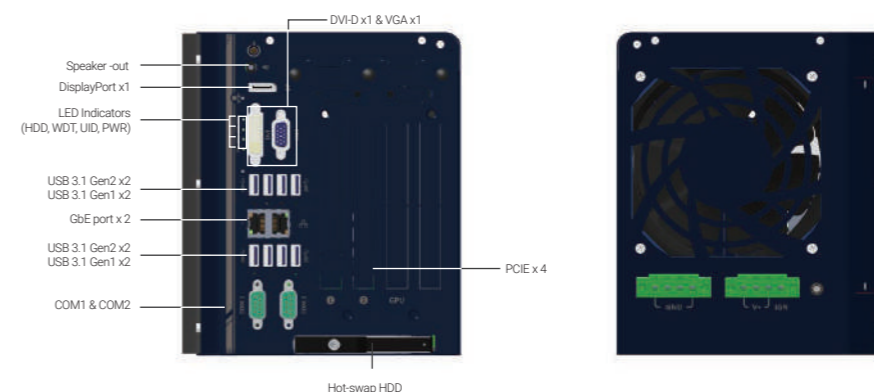

Dimensions

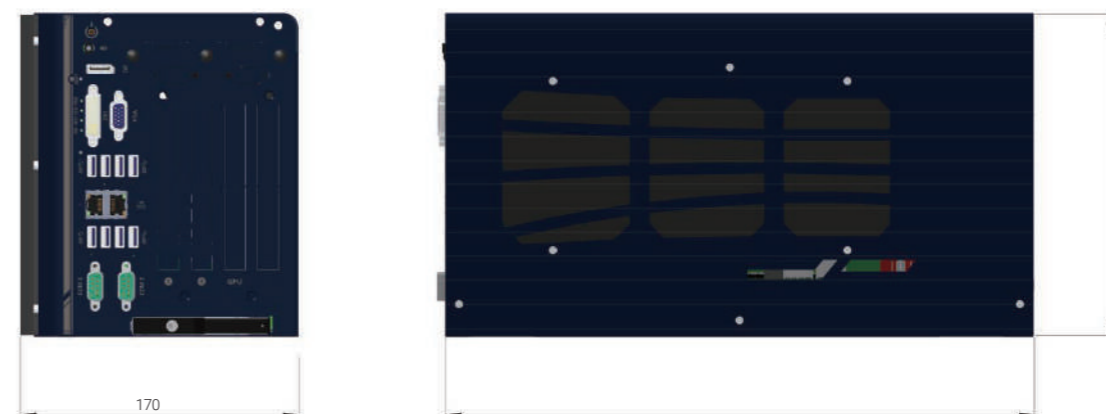

Ordering Information

Model No.	Product Description
Nuvo-8108GC	Industrial-grade edge AI platform supporting 250W NVIDIA® GPU Card, Intel® Xeon® E and 9th/ 8th-Gen Core™ processor with 8 to 48V wide-range DC input and built-in ignition control

Optional Accessories

PA-480W-DIN	480W AC-DC power Adapter(SDR-480-24) DIN-rail mount, 24V 20A, 90~264VAC/127~370VDC, Terminal Block, -20~+70°C, Meanwell SDR-480-24
--------------------	--

Nuvo-8240GC

Industrial-grade edge AI platform supporting dual NVIDIA® Tesla T4 and Intel® Xeon® E and 9th/ 8th-Gen Core™ processor

Key Features

- Supports dual NVIDIA® Tesla T4 GPU
- Supports Intel® Xeon® E or 9th/ 8th-Gen Core™ i7/ i5 LGA1151 CPU
- Up to 128GB ECC/ non-ECC DDR4 2133 (4x SODIMM)
- Two x8 (4-lanes), Gen3 PCIe slots for add-on cards
- 1x M.2 M key, 1x M.2 B key and 2x full-size mini-PCIe sockets
- 8 to 48V wide-range DC input with built-in ignition power control
- Proven thermal design for -25°C to 60°C rugged operation*
- Patented damping brackets* to withstand 3 Grms vibration



CE FC

*R.O.C Patent No. M491752

Introduction

Nuvo-8240GC is a rugged edge AI platform designed specifically to support dual NVIDIA® Tesla T4 for advanced inference acceleration applications. It features NVIDIA multi-precision Turing Tensor Cores offering tremendous GPU power up to 130 TFLOPS in FP16 and 520 TOPS in INT4 for emerging GPU-accelerated edge computing and advanced AI inference. In addition, Nuvo-8240GC is powered by Intel® Xeon® E or 9th/ 8th-Gen Core™ CPU up to 8-core/ 16-thread coupled with workstation-grade Intel® C246 chipset to support up to 128 GB ECC or non-ECC DDR4 memory.

The system incorporates one internal 2.5" SATA HDD/ SSD slot and one hot-swappable 2.5" tray for easy HDD/ SSD replacement. There is also an M.2 2280 NVMe SSD socket for ultimate disk performance. Its front-accessible GbE and USB 3.1 Gen1/ Gen2 ports feature screw-lock mechanisms for secure cable connections. In addition to the dual x16 PCIe slots (8-lanes) for Tesla T4 installation, Nuvo-8240GC has other two x8 PCIe slots (4-lanes) for expansion cards to extend function sets, making it that much more flexible for specific applications such as data collection, analytics and communication.

Nuvo-8240GC has a brand new power delivery design to accept 8 to 48V wide-range DC input with built-in ignition control. Mechanical wise, Nuvo-8240GC incorporates Neosys' proven heat dissipation design, damping brackets* for withstanding 3 Grms vibration, making it steady and rock-solid in various conditions. The Nuvo-8240GC is Neosys' response to the never-ending performance demand in industrial edge AI platforms and now with double the inference power, Nuvo-8240GC is ready to take it to the next level.

Specifications

System Core		Expansion Bus	
Processor	Supporting Intel® Xeon® E and 9th/ 8th-Gen CPU (LGA1151 socket) - Xeon E 2176G/ 2278GE (8C/16T) / 2278GEL (8C/16T) - i7-9700E/ i7-9700TE/ i7-8700/ i7-8700T - i5-9500E/ i5-9500TE/ i5-8500/ i5-8500T - i3-9100E/ i3-9100TE/ i3-8100/ i3-8100T	PCI Express	2x PCIe x16 slot@Gen3, 8-lanes 2x PCIe x8 slots@Gen3, 4-lanes
Chipset	Intel® C246 Platform Controller Hub	M.2	1x M.2 2242 B key socket supporting dual SIM mode with selected M.2 LTE module
Graphics	Integrated Intel® UHD Graphics 630	Mini-PCIe	2x full-size mini PCI Express socket
Memory	Up to 128 GB ECC/ non-ECC DDR4 2133 SDRAM (four SODIMM slots)	Power Supply	
AMT	Supports AMT 12.0	DC Input	1x 4-pin pluggable terminal block for 8 to 48V DC input with ignition control
TPM	Supports TPM 2.0	Mechanical	
I/O Interface		Dimension	190 mm (W) x 271 mm (D) x 198.5 mm (H)
Ethernet	1x Gigabit Ethernet port by Intel® I219-LM 1x Gigabit Ethernet port by Intel® I210-IT	Weight	5 kg
Video Port	1x VGA, supporting 1920 x 1200 resolution 1x DVI-D, supporting 1920 x 1200 resolution 1x DisplayPort, supporting 4096 x 2304 resolution	Mounting	Wall-mount with damping brackets
Serial Port	2x software-programmable RS-232/ 422/ 485 ports (COM1/COM2)	Environmental	
USB 3.1	4x USB 3.1 Gen2 (10 Gbps) ports 4x USB 3.1 Gen1 (5 Gbps) ports	Operating Temperature	with 35W CPU -25°C ~ 60°C **/** with 65W CPU -25°C ~ 60°C **/** (configured as 35W TDP mode) -25°C ~ 50°C **/** (configured as 65W TDP mode) In compliance with NVIDIA® Tesla T4 warranty policy, an operating temperature of 0°C~50°C is required for systems with Tesla T4 installed
USB 2.0	1x USB 2.0 ports (internal use)	Storage Temperature	-40°C ~ 85°C
Audio	1x 3.5 mm jack for mic-in and speaker-out	Humidity	10%~90% , non-condensing
Storage Interface		Vibration	Operating, MIL-STD-810G, Method 514.6, Category 4 and 3Grms
SATA	1x hot-swappable HDD tray for 2.5" HDD/ SSD installation 1x Internal SATA port for 2.5" HDD/ SSD installation, supporting RAID 0/ 1	Shock	Operating, MIL-STD-810G, Method 516.6, Procedure I, Table 516.6-II
M.2	1x M.2 2280 M key socket (PCIe Gen3 x4) for NVMe SSD or Intel® Optane™ memory installation	EMC	CE/FCC Class A, according to EN 55032 & EN 55024
mSATA	2x full-size mSATA port (mux with mini-PCIe)		

** For i7-9700E and i7-8700 running at 65W mode, the highest operating temperature shall be limited to 50°C and thermal throttling may occur when sustained full-loading applied. Users can configure CPU power in BIOS to obtain higher operating temperature.
*** For sub-zero operating temperature, a wide temperature HDD or Solid State Disk (SSD) is required.

Appearance

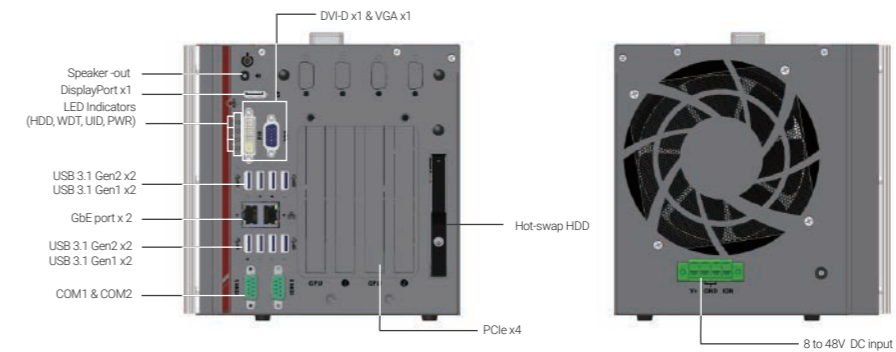

Dimensions

Unit : mm

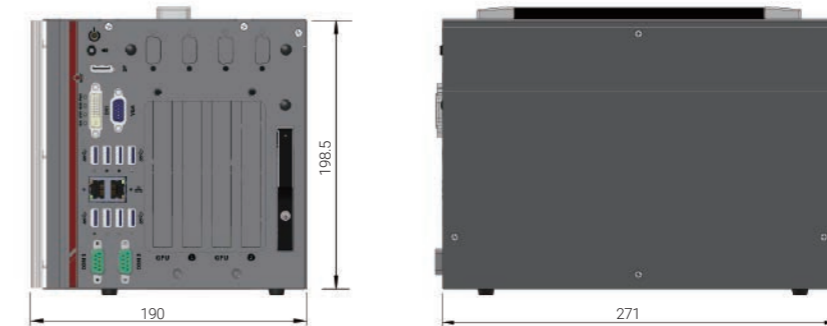

Ordering Information

Model No.	Product Description
Nuvo-8240GC	Industrial-grade edge AI platform supporting dual NVIDIA® Tesla T4 and Intel® Xeon® E and 9th/ 8th-Gen Core™ processor

Optional Accessories

PA-280W-ET2	280W AC/DC power adapter 24V/11.67A; 16AWG/100cm; cord end terminals for terminal block, operating temperature : -30°C to 60°C
-------------	--

Nuvo-6108GC/ Nuvo-6108GC-IGN

Industrial-grade In-vehicle GPU-computing Platform with 250W NVIDIA® GPU and Intel® Xeon® E3 v5 and 6th-Gen Core™ Processor



Key Features

- Supports Intel® Xeon® E3 v5 or 6th-Gen Core™ i7/ i5 LGA1151 CPU
- Supports NVIDIA® GPU (up to 250W TDP)
- Patented thermal design for -25 °C to 60 °C rugged operation*
- Two x8, Gen3 PCIe slots for add-on cards
- Dual GbE ports and four USB 3.1 ports
- Four 2.5" SATA hard drives with RAID 0/ 1/ 5/ 10 support
- Three 2.5" SATA hard drives with RAID 0/ 1/ 5 support (Nuvo-6108GC-IGN)
- Patented easy-swap trays* for HDD replacement (Nuvo-6108GC-IGN)
- Automatic temperature sensing and fan control
- Patented damping brackets* to withstand 1 Grms vibration
- Built-in ignition control (Nuvo-6108GC-IGN)

*R.O.C Patent No. M534371 / M491241 / M491752



Introduction

Nuvo-6108GC series is world's first industrial-grade GPU computer supporting high-end graphics cards. It's designed to fuel emerging GPU-accelerated applications, such as artificial intelligence, VR, autonomous driving and CUDA computing by accommodating a 250W NVIDIA® GPU.

Leveraging Intel® C236 chipset, Nuvo-6108GC series supports Xeon® E3 v5 or 6th-Gen Core™ i7/ i5 CPU with up to 32 GB ECC/ non-ECC DDR4 memory. It incorporates general computer I/O like Gigabit Ethernet, USB 3.1 and serial ports. In addition to the x16 PCIe port for GPU installation, Nuvo-6108GC series also has two x8 PCIe slots so you can install additional high performance expansion card with high bandwidths for data collection analytics and communication.

Nuvo-6108GC series comes with sophisticated power design to handle heavy power consumption and power transient of a 250W GPU. Furthermore, to have reliable GPU performance for industrial environments, Nuvo-6108GC series utilizes Neosys' patented design*, a tuned cold air intake to effectively dissipate the heat generated by GPU. This unique design guarantees operation at 60°C under 100% GPU loading, making Nuvo-6108GC series extremely reliable for demanding field applications.

The new model Nuvo-6108GC-IGN features built-in ignition power control and two of its three 2.5" drives come with Neosys' patented easy-swap trays for simple HDD/ SSD replacement.

Specifications

System Core		Expansion Bus/ Internal I/O Interface	
Processor	Intel® Xeon® E3 v5 or 6th-Gen Core™ LGA1151 CPU	PCI Express	1x PCIe x16 slot @ Gen3, 16-lanes PCIe signals for GPU 2x PCIe x8 slot @ Gen3, 4-lanes PCIe signals
	- Intel® Xeon® Processor E3-1275 v5 (8M Cache, 3.6/ 4.0 GHz)	M.2	1x M.2 B key socket for 3G/4G options with SIM socket
	- Intel® Xeon® Processor E3-1268L v5 (8M Cache, 2.4/ 3.4 GHz)	mini-PCIe	1x full-size mini PCI Express socket
	- Intel® Core™ i7-6700 (8M Cache, 3.4/ 4.0 GHz)	Remote Ctrl. & Status Output	1x 2x6-pin 2.0mm pin-header connector for remote on/ off control and status LED output
	- Intel® Core™ i5-6500 (6M Cache, 3.2/ 3.6 GHz)	Power Supply	
- Intel® Core™ i7-6700TE (8M Cache, 2.4/ 3.4 GHz)	DC Input	24V DC input	
- Intel® Core™ i5-6500TE (6M Cache, 2.3/ 3.3 GHz)	Input Connector	3-pin pluggable terminal block for DC input (IGN/ GND/ V+) (Nuvo-6108GC-IGN)	
Chipset	Intel® C236 platform controller hub	Mechanical	
Graphics	Independent GPU via x16 PEG port, or integrated Intel® HD 530 controller	Dimension	167 mm (W) x 360 mm (D) x 174 mm (H) (Nuvo-6108GC) 178 mm (W) x 360 mm (D) x 174 mm (H) (Nuvo-6108GC-IGN)
Memory	Up to 32 GB ECC/ non-ECC DDR4-2133	Weight	4.7 kg (incl. CPU, GPU, memory and HDD)
I/O Interface		Mounting	Wall-mount with damping brackets
Ethernet	1x Gigabit Ethernet port by Intel® I219-LM 1x Gigabit Ethernet port by Intel® I210-IT	Environmental	
Video Port	2x DVI-Ds for DVI outputs, supporting 1920x1200 resolution	Operating Temperature	-25°C ~ 60°C with 100% CPU/ GPU loading **/***
Serial Port	2x software-programmable RS-232/ 422/ 485 ports	Storage Temperature	-40°C ~ 85°C
USB 3.1	4x USB 3.1 Gen1 (5 Gbps) ports	Humidity	10%~90% , non-condensing
Audio	1x speaker-out	Vibration	Operating, 1 Grms, 5-500 Hz, 3 Axes (w/ GPU, fan and HDD), according to IEC60068-2-64)
Storage Interface		EMC	CE/ FCC Class A, according to EN 55022, EN 55024 & EN 55032
SATA	4x SATA ports for 2.5" HDD/ SSD installation, supporting RAID 0/ 1/ 5/ 10 (Nuvo-6108GC) 2x easy-swap HDD trays for 2.5" HDD/ SSD installation (Nuvo-6108GC-IGN) 1x Internal SATA port for 2.5" HDD/ SSD installation, supporting RAID 0/ 1/ 5 (Nuvo-6108GC-IGN)		

** For i7-6700 running at 65W mode, the highest operating temperature shall be limited to 50°C and thermal throttling may occur when sustained full-loading applied. Users can configure CPU power in BIOS to obtain higher operating temperature.

*** For sub-zero operating temperature, a wide temperature HDD drive or Solid State Disk (SSD) is required.

Appearance

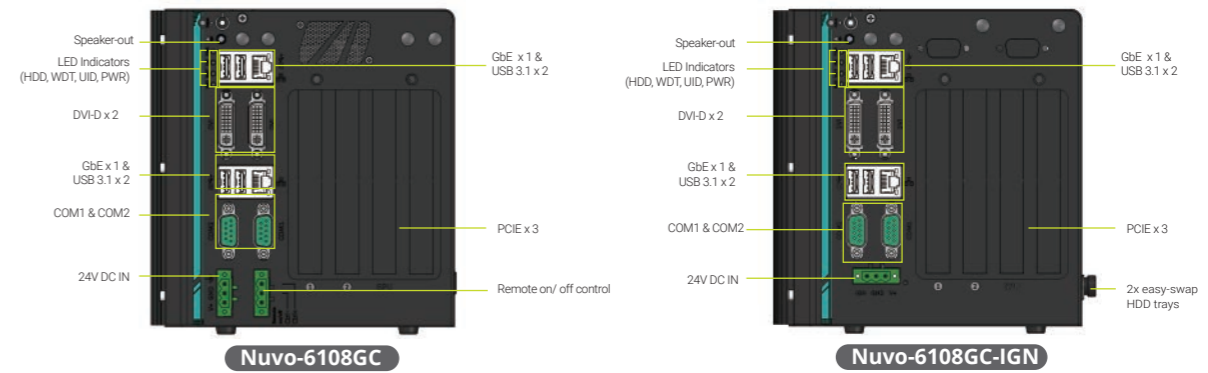

Dimensions

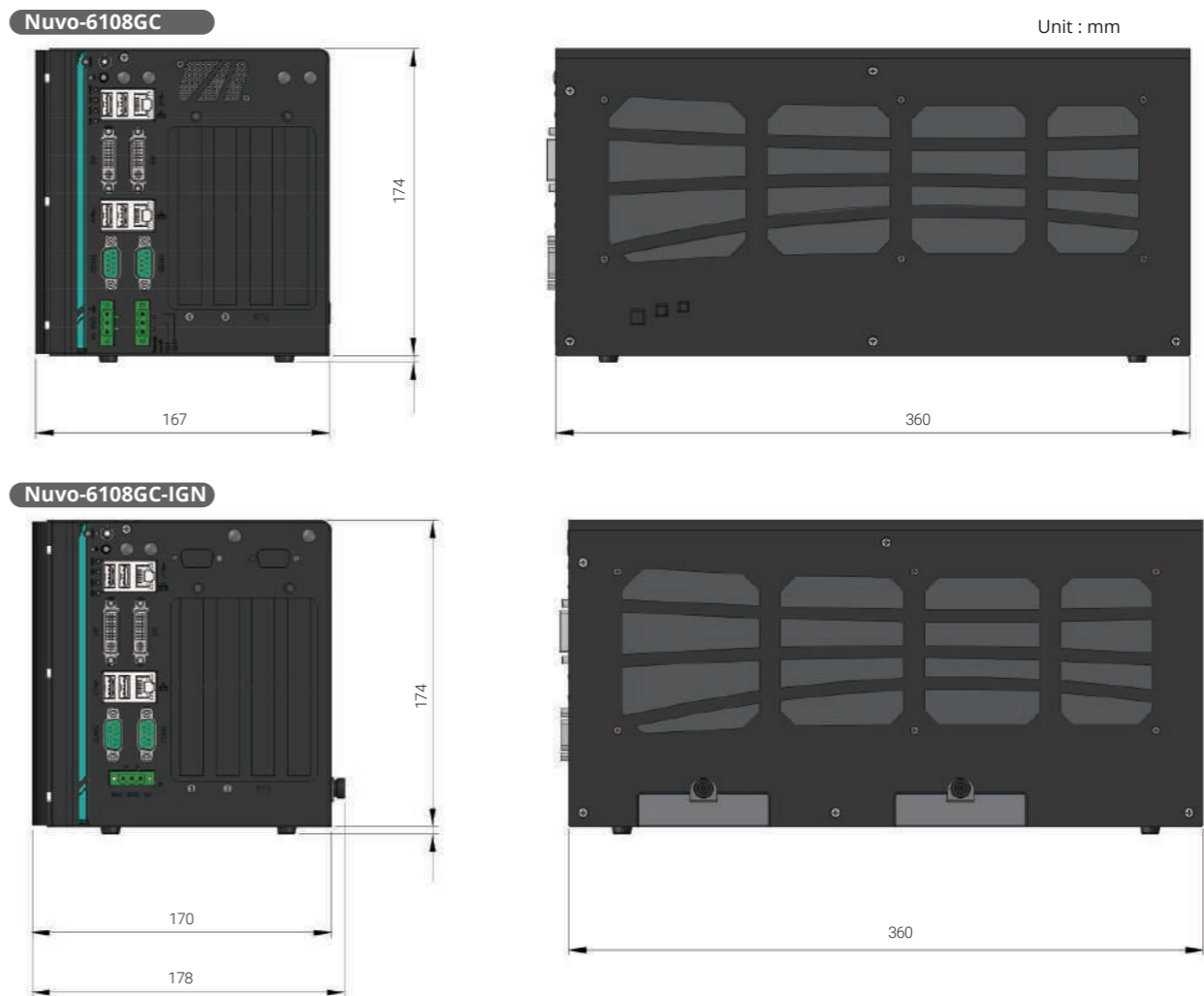

Ordering Information

Model No.	Product Description
Nuvo-6108GC	Industrial-grade GPU computing platform supporting 250W NVIDIA® graphics card and Intel® Xeon® E3 v5 and 6th-Gen Core™ processor
Nuvo-6108GC-IGN	Industrial-grade GPU computing platform supporting up to 250W NVIDIA® graphics card, Intel® Xeon® E3 v5 and 6th-Gen Core™ processor with built-in ignition control and 2x easy-swap trays

Optional Accessories

PA-480W-DIN	480W AC-DC power adapter DIN-rail mount, 24V 20A, 90~264VAC/127~370VDC, terminal block, -20 to 70°C, Meanwell SDR-480-24
-------------	--

Nuvo-9160GC Series

Ruggedized AI Inference Platform supporting 130W NVIDIA® RTX GPU and Intel® 13th/ 12th-Gen Core™ Processor

Key Features

- Supports Intel® 13th/ 12th-Gen Core™ up to 24C/ 32T 35W/ 65W CPU
- Support NVIDIA® RTX series GPU card up to 130W TDP
- -25°C to 60°C wide temperature rugged operation
- 5x 2.5GbE and 1xGbE with optional PoE+ (ports 3~6)
- 1x USB 3.2 Gen2x2 type-C and 6x USB 3.2 type-A ports
- M.2 2280 M key socket (Gen4x4) supporting NVMe SSD
- Accommodates two 2.5" SATA HDD/ SSD with RAID 0/ 1 support
- MezzIO® interface for add-on expansion



CE FC

*R.O.C Patent No. M534371/ M456527

Introduction

Nuvo-9160GC is a rugged edge AI computer that delivers superior CPU and GPU performance by leveraging Intel's 13th/12th-Gen platform and NVIDIA's 130W RTX GPU card.

Benefiting from the cutting-edge Intel® 7 photolithography, Intel's 13th/ 12th Gen processors can offer up to 24 cores/ 32 threads with 2x the performance improvement compared to previous Intel 11th/ 10th Gen platforms. The latest NVIDIA® 130W RTX GPU contributes nearly 9 TFLOPS of FP32 performance to fuel real-time AI inference applications involving multiple cameras such as production line vision inspection, intelligent video analytics for surveillance or ITS, or autonomous mobile robot (AMR).

Nuvo-9160GC has a proven thermal design to guarantee reliable system operation from -25°C to 60°C. It features a passive-cooling design for the motherboard and segregated patented ventilation design* for the 130W GPU card within Neosys' patented expansion Cassette*. The support of six GigE cameras (or IP cameras) and six USB3 cameras makes Nuvo-9160GC ideal for various vision-based AI application deployments. It also provides flexible data storage options, including one M.2 2280 Gen4x4 NVMe providing up to 7000 MB/s extreme read/write speeds and two 2.5" SATA HDD/SSD to expand storage capacity.

With performance enhancements and comprehensive I/Os, Nuvo-9160GC is the perfect edge AI inference platform for industrial environments from factory automation, smart agriculture, and autonomous machines.

Specifications

System Core		Expansion Bus			
Processor	Supporting Intel® 13th-Gen Core™ CPU (LGA1700 socket, 65W/ 35W TDP)	PCI Express	1x PCIe x16 slot@Gen3, 16-lanes PCIe signals in Cassette for installing an NVIDIA® graphics card up to 130W TDP (Max. graphics card dimension is 188 mm(L) x 131 mm(W), dual slot allocation)		
	- Intel® Core™ i9-13900E/ i9-13900TE		Mini PCI Express	1x full-size mini PCI Express socket	
	- Intel® Core™ i7-13700E/ i7-13700TE			M.2	1x M.2 3042/3052 B key socket with SIM slot for M.2 4G/ 5G module
	- Intel® Core™ i5-13500E/ i5-13400E/ i5-13500TE				Expandable I/O
- Intel® Core™ i3-13100E/ i3-13100TE	Supporting Intel® 12th-Gen Core™ CPU (LGA1700 socket, 65W/ 35W TDP)	Power Supply			
Chipset	Intel® Q670E Platform Controller Hub	DC Input	1x 3-pin pluggable terminal block for 8 to 48V DC input		
Graphics	Integrated Intel® UHD Graphics 770 (32EU) / 730 (24EU)	Remote Ctrl. & LED Output	1x 3-pin pluggable terminal block for remote control and PWR LED output		
Memory	Up to 64 GB DDR5 4800 SDRAM (two SODIMM slots)	Mechanical			
AMT	Supports Intel vPro® AMT 16.0	Dimension	240 mm (W) x 225 mm (D) x 110.5 mm (H)		
TPM	Supports dTPM 2.0	Weight	3.89 kg		
I/O Interface		Mounting	Wall-mount (standard) or damping bracket (optional)		
Ethernet	5x 2.5G Ethernet by I225-IT and 1x Gigabit Ethernet by I219-LM with screw-lock	Environmental			
PoE+	Optional IEEE 802.3at PoE+ PSE for Port 3 ~ Port 6. 100W total power budget	Operating Temperature	With 35W CPU and 130W GPU -25°C to 60°C** With 65W CPU and 130W GPU -25°C to 60°C**/** (configured as 35W TDP) -25°C to 50°C**/** (configured as 65W TDP)		
USB 3.2	1x USB 3.2 Gen2x2 (20 Gbps) port in type-C connector with screw-lock 4x USB 3.2 Gen2x1 (10 Gbps) ports in type-A connectors 2x USB 3.2 Gen1x1 (5 Gbps) ports in type-A connectors	Storage Temperature	-40°C to 85°C		
USB 2.0	2x USB 2.0 ports	Humidity	10% to 90% , non-condensing		
Video Port (Integrated Graphics)	1x VGA connector, supporting 1920 x 1200 resolution 1x DVI-D connector, supporting 1920 x 1200 resolution 1x DisplayPort connector, supporting 4096 x 2304 resolution	Vibration	Operating, MIL-STD-810G, Method 514.6, Category 4 (with optional damping bracket) (pending)		
Serial Port	2x software-programmable RS-232/ 422/ 485 ports (COM1/COM2) 2x RS-232 ports (COM3/COM4)	Shock	Operating, MIL-STD-810G, Method 516.6, Procedure I, Table 516.6-II (with optional damping bracket) (pending)		
Audio	1x 3.5 mm jack for mic-in and speaker-out	EMC	CE/FCC Class A, according to EN 55032 & EN 55035 (pending)		
Storage Interface		* Due to I225-IT specification limitation, for systems running 2.5G Ethernet link speeds, please limit the operating temperature to 60°C.			
SATA HDD	2x internal SATA port for 2.5" HDD/ SSD installation, supporting RAID 0/ 1	** For sub-zero operating temperature, a wide temperature HDD or Solid State Disk (SSD) is required.			
M.2	1x M.2 2280 M key socket (PCIe Gen4 x4) for NVMe SSD	*** For CPU operating at 65W mode, the highest operating temperature shall be limited to 50°C and thermal throttling may occur when sustained full-loading applied. Users can configure CPU power in BIOS to allow higher operating temperature.			

* Due to I225-IT specification limitation, for systems running 2.5G Ethernet link speeds, please limit the operating temperature to 60°C.

** For sub-zero operating temperature, a wide temperature HDD or Solid State Disk (SSD) is required.

*** For CPU operating at 65W mode, the highest operating temperature shall be limited to 50°C and thermal throttling may occur when sustained full-loading applied. Users can configure CPU power in BIOS to allow higher operating temperature.

Appearance

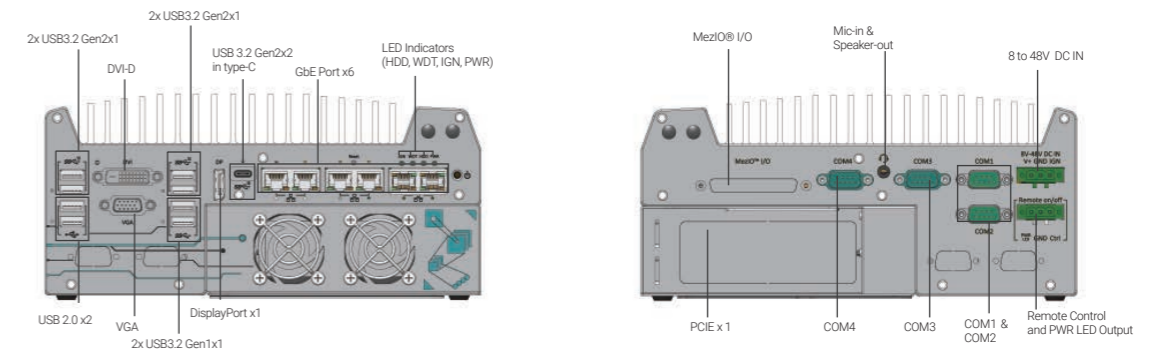

Dimensions

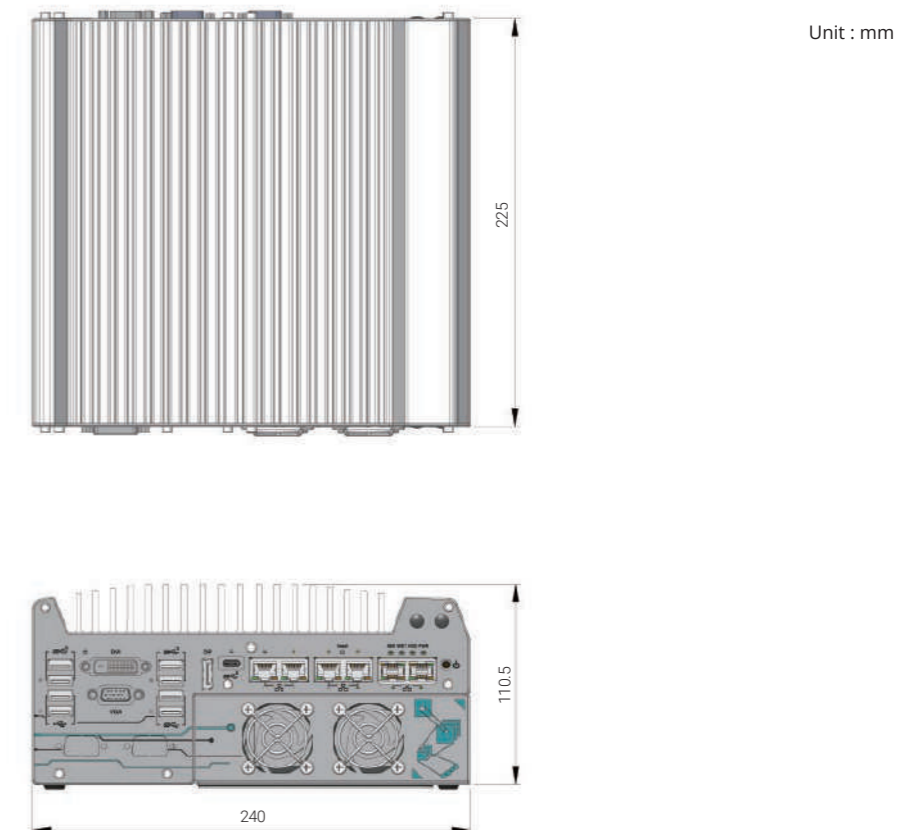

Ordering Information

Model No.	Product Description
Nuvo-9160GC	Ruggedized AI Inference Platform supporting 130W NVIDIA® RTX GPU and Intel® 13th/ 12th-Gen Core™ Processor
PoE+ Option	Option of 802.3at PoE + PSE for 2.5GbE port 3 ~ port 6

Optional Accessories

PA-280W-ET2	280W AC/DC power adapter 24V/11.67A; 16AWG/100cm; cord end terminals for terminal block, operating temperature : -30°C to 60°C.
PA-600W-ENC	600W AC/DC power adapter 24V/25A; cord end terminals for terminal block, operating temperature : -20°C to 70°C.
Dmpbr-Nuvo9160	Neosys' patented damping brackets assembly for Nuvo-9160GC

Nuvo-7168GC Series

Ruggedized AI Inference Platform Supporting NVIDIA® RTX A2000 and Intel® 9th/ 8th-Gen Core™ Processor

Key Features

- Supports NVIDIA® RTX A2000 GPU
- -25°C to 60°C wide-temperature operation
- Intel® 9th/ 8th-Gen Core™ hexa-core 35W/ 65W LGA1151 CPU
- 6x GigE ports, 802.3at PoE+ option available (ports 3~6)
- M.2 2280 M key NVMe (Gen3 x4) socket for fast storage access
- 4x USB 3.1 Gen2 ports and 4x USB 3.1 Gen1 ports
- Accommodates two 2.5" SATA HDD/ SSD with RAID 0/ 1 support
- MeziO® interface for easy function expansion



CE FC

*R.O.C Patent No. M534371/ M456527

Introduction

Nuvo-7168GC series is a ruggedized AI inference platform supporting NVIDIA® RTX A2000 GPU which offers better longevity for industrial AI inference applications, such as machine vision inspection, machine automation, and intelligent video analytics. Operating with NVIDIA® RTX A2000, Nuvo-7168GC delivers 8 TFLOPS in FP32 GPU computing power for real-time AI inference.

Nuvo-7168GC inherits the market-proven passive cooling design for motherboard components; Neosys' patented Cassette module to segregate electrical and heat interferences; the innovative "tunneled" ventilation design for add-on cards that can efficiently dissipate the heat generated by RTX A2000, and together, they sustain optimum performance for both the CPU and GPU in high-temperature environments.

Nuvo-7168GC series offers an abundance of cutting-edge I/O connections. It has six GbE ports and eight USB3.1 ports for connecting to industrial cameras or IP cameras. An M.2 2280 NVMe interface is provided internally for fast storage access supporting over 2000 MB/s read/ write speeds. Moreover, Nuvo-7168GC supports Neosys' proprietary MeziO® interface for further I/O expansions such as isolated DIO, COM ports, or more GbE ports.

By supporting RTX A2000, Nuvo-7168GC series provides a great cost/ performance ratio for AI inference computing and superior system longevity so users need not worry about the frequent change of GPU configuration. Nuvo-7168GC is the ideal ruggedized AI inference platform for emerging industrial edge AI applications.

Specifications

System Core		Internal Expansion Bus	
Processor	Supporting Intel® 9th/ 8th Gen Core™ CPU (LGA1151 socket, 65W/35W TDP) - Intel® Core™ i7-9700E/ i7-9700TE/ i7-8700/ i7-8700T - Intel® Core™ i5-9500E/ i5-9500TE/ i5-8500/ i5-8500T - Intel® Core™ i3-9100E/ i3-9100TE/ i3-8100/ i3-8100T	PCI/PCI Express	1x PCIe x16 slot@Gen3, 16-lanes PCIe signal in Cassette for installing RTX A2000 GPU
Chipset	Intel® Q370 platform controller hub	Mini PCI Express	1x full-size mini PCI Express socket with internal SIM socket (mux with mSATA)
Graphics	Integrated Intel® UHD graphics 630	M.2	1x M.2 2242 B key socket with dual front-accessible SIM sockets, supporting dual SIM mode with selected M.2 LTE module
Memory	Up to 64 GB DDR4 2666/ 2400 SDRAM (two SODIMM slots)	Expandable I/O	1x MeziO® expansion port for Neosys MeziO® modules
AMT	Supports AMT 12.0	Power Supply	
TPM	Supports TPM 2.0	DC Input	1x 3-pin pluggable terminal block for 8 - 35V DC input
I/O Interface		Remote Ctrl. & LED Output	1x 3-pin pluggable terminal block for remote control and PWR LED output
Ethernet	6x Gigabit Ethernet ports by I219 and 5x I210	Mechanical	
PoE+	Optional IEEE 802.3at PoE+ PSE for port 3 ~ port 6 100 W total power budget	Dimension	240 mm (W) x 225 mm (D) x 111 mm (H)
USB 3.1	4x USB 3.1 Gen2 (10 Gbps) ports 4x USB 3.1 Gen1 (5 Gbps) ports	Weight	4.5 Kg
Video Port (Integrated Graphics)	1x VGA, supporting 1920 x 1200 resolution 1x DVI-D, supporting 1920 x 1200 resolution 1x DisplayPort, supporting 4096 x 2304 resolution	Mounting	Wall-mount mounting bracket
Serial Port	2x software-programmable RS-232/422/485 ports (COM1/ COM2) 2x RS-232 ports (COM3/ COM4)	Environmental	
Audio	1x 3.5 mm jack for mic-in and speaker-out	Operating Temperature	with 35W CPU and RTX A2000 -25°C ~ 60°C ** with 65W CPU and RTX A2000 -25°C ~ 60°C */ ** (configured as 35W TDP mode) -25°C ~ 50°C */ ** (configured as 65W TDP mode)
Storage Interface		Storage Temperature	-40°C ~ 85°C
SATA HDD	2x internal SATA ports for 2.5" HDD/ SSD installation, supporting RAID 0/ 1	Humidity	10%~90%, non-condensing
M.2 NVMe	1x M.2 2280 M key NVMe socket (PCIe Gen3 x4) for NVMe SSD installation	Vibration	Operating, MIL-STD-810G, Method 514.6, Category 4
mSATA	1x full-size mSATA port (mux with mini-PCIe)	Shock	Operating, MIL-STD-810G, Method 516.6, Procedure I, Table 516.6-II
		EMC	CE/FCC Class A, according to EN 55032 & EN 55035

* For i7-9700E and i7-8700 running at 65W mode, the highest operating temperature shall be limited to 50°C and thermal throttling may occur when sustained full-loading applied. Users can configure CPU power in BIOS to obtain higher operating temperature.

** For sub-zero operating temperature, a wide temperature HDD or Solid State Disk (SSD) is required.

Appearance

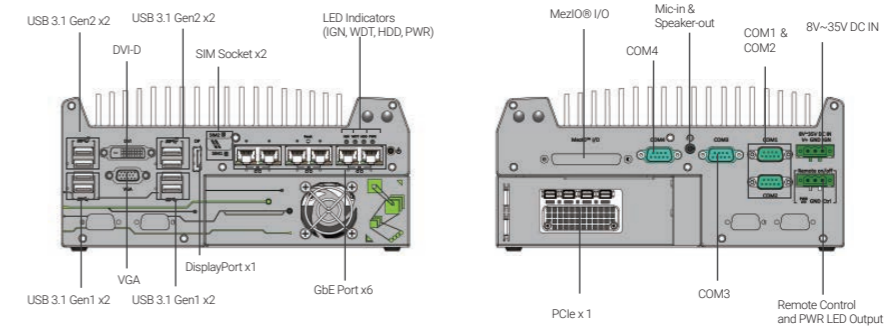

Dimensions

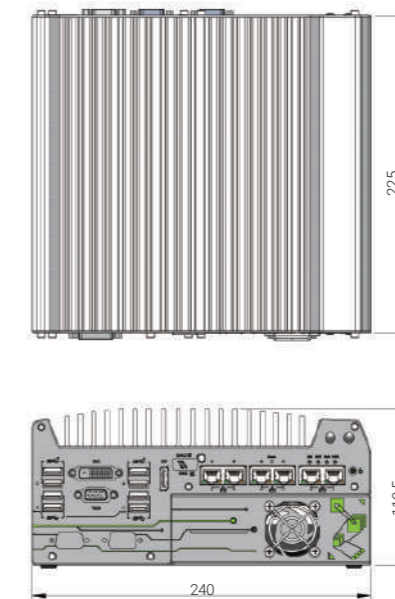

Unit : mm

Ordering Information

Model No.	Product Description
Nuvo-7168GC	Intel® 9th/ 8th-Gen Core™ AI Inference Platform with 6x GbE and MeziO®, supporting NVIDIA® RTX A2000
	Optional IEEE 802.3at PoE+ for GbE ports 3 ~ 6

Optional Accessories

PA-280W-ET2	280W AC/DC power adapter 24V/11.67A; 16AWG/100cm; cord end terminals for terminal block, operating temperature: -30°C to 60°C.
Damping bracket	Neosys' patented damping brackets assembly for Nuvo-7160GC/ Nuvo-7162GC/ Nuvo-7164GC/ Nuvo-7166GC/ 7168GC
MeziO® Modules	
MeziO®-C180	MeziO® module with 4x RS-232/ 422/ 485 ports and 4x RS-232 ports
MeziO®-C181	MeziO® module with 4x RS-232/ 422/ 485 ports and 4x RS-422/ 485 ports
MeziO®-D220	MeziO® module with 8-CH isolated digital input and 8-CH isolated digital output
MeziO®-D230	MeziO® module with 16-CH isolated digital input and 16-CH isolated digital output
MeziO®-V20-EP	MeziO® module with ignition power control function for in-vehicle application
MeziO®-U4	MeziO® module with 4x USB 3.1 ports
MeziO®-G4	MeziO® module with 4x GigE ports
MeziO®-G4P	MeziO® module with 4x IEEE 802.3at PoE+ ports

* Only Nuvo-7168GC-PoE support MeziO-G4P

Nuvo-7164GC/ Nuvo-7166GC Series

Ruggedized AI Inference Platform Supporting NVIDIA® Tesla T4 and Intel® 9th/ 8th-Gen Core™ Processor

Key Features

- Supports NVIDIA® Tesla T4 GPU
- One additional PCIe x16 slot for add-on card (Nuvo-7166GC only)
- Dedicated heat dissipation for -25°C to 60°C wide temperature operation
- Intel® 9th/ 8th-Gen Core™ hexa-core 35W/ 65W LGA1151 CPU
- 6x GigE ports, 802.3at PoE+ option available (ports 3~6)
- M.2 2280 M key NVMe (Gen3 x4) socket for fast storage access
- 4x USB 3.1 Gen2 ports and 4x USB 3.1 Gen1 ports
- Accommodates two 2.5" SATA HDD/ SSD with RAID 0/1 support
- MeziO® interface for easy function expansion



*R.O.C Patent No. M534371/ M456527

Introduction

Nuvo-7164GC/Nuvo-7166GC series are ruggedized AI inference platforms designed for advanced inference acceleration applications such as voice, video, image and recommendation services. It supports NVIDIA® Tesla T4 GPU, featuring 8.1 TFLOPS in FP32 and 130 TOPs in INT8 for real-time inference based on trained neural network model. In addition, it supports Intel® 9th/ 8th-Gen Core™ 6-core/ 8-core CPU and 64 GB DDR4-2666, offering great balance between CPU, GPU and memory performance.

Thanks to Neosys' patented Cassette and air tunnel design, which guides the intake air to flow through the passive heat sink of NVIDIA® Tesla T4 making it capable of effectively dissipating the heat generated by the GPU. This promising design guarantees system operation of up to 60°C ambient temperature with sustained 100% GPU loading. What distinguishes Nuvo-7166GC from Nuvo-7164GC is that it has one additional PCIe x16 slot in the Cassette module for a second add-on card installation, making it that much more flexible for specific applications.

Both systems incorporate cutting-edge I/O technologies to boost overall system flexibility, functionality and performance. The systems feature an M.2 NVMe interface that supports disk read/ write speeds over 2000 MB/s and USB 3.1/ GbE ports for fast data transfer, such as acquiring HD video data. With the combination of a fast CPU and inference accelerator GPU, Nuvo-7164GC/ Nuvo-7166GC are ideal inference platforms for artificial intelligence applications.

Specifications

	Nuvo-7164GC	Nuvo-7166GC
System Core		
Processor	Supporting Intel® 9th/ 8th-Gen CPU (LGA1151 socket, 65W/ 35W TDP) - Intel® Core™ i7-8700/ i7-8700T/ i7-9700E/ i7-9700TE - Intel® Core™ i5-8500/ i5-8500T/ i5-9500E/ i5-9500TE - Intel® Core™ i3-8100/ i3-8100T/ i3-9100E/ i3-9100TE	
Chipset	Intel® Q370 platform controller hub	
Graphics	Integrated Intel® UHD graphics 630	
Memory	Up to 64 GB DDR4 2666/ 2400 SDRAM (two SODIMM slots)	
AMT	Supports AMT 12.0	
TPM	Supports TPM 2.0	
I/O Interface		
Ethernet	6x Gigabit Ethernet ports by I219 and 5x I210	
PoE+	Optional IEEE 802.3at PoE+ PSE for port 3 ~ port 6 100 W total power budget	
USB 3.1	4x USB 3.1 Gen2 (10 Gbps) ports 4x USB 3.1 Gen1 (5 Gbps) ports	
Video Port (Integrated Graphics)	1x VGA, supporting 1920 x 1200 resolution 1x DVI-D, supporting 1920 x 1200 resolution 1x DisplayPort, supporting 4096 x 2304 resolution	
Serial Port	2x software-programmable RS-232/422/485 ports (COM1/ COM2) 2x RS-232 ports (COM3/ COM4)	
Audio	1x 3.5 mm jack for mic-in and speaker-out	
Storage Interface		
SATA HDD	2x internal SATA ports for 2.5" HDD/ SSD installation, supporting RAID 0/ 1	
M.2 NVMe	1x M.2 2280 M key NVMe socket (PCIe Gen3 x4) for NVMe SSD installation	
mSATA	1x full-size mSATA port (mux with mini-PCIe)	
	Nuvo-7164GC	Nuvo-7166GC
Internal Expansion Bus		
PCI/PCI Express	1x PCIe x16 slot@Gen3, 16-lanes PCIe signal in Cassette for installing NVIDIA® Tesla T4 GPU	2x PCIe x16 slot@Gen3, 8-lanes PCIe signal in Cassette for installing NVIDIA® Tesla T4 GPU and one additional PCIe card
Mini PCI Express	1x full-size mini PCI Express socket with internal SIM socket (mux with mSATA)	
M.2	1x M.2 2242 B key socket with dual front-accessible SIM sockets, supporting dual SIM mode with selected M.2 LTE module	
Expandable I/O	1x MeziO® expansion port for Neosys MeziO® modules	
Power Supply		
DC Input	1x 3-pin pluggable terminal block for 8 to 35V DC input	
Remote Ctrl. & LED Output	1x 3-pin pluggable terminal block for remote control and PWR LED output	
Mechanical		
Dimension	240 mm (W) x 225 mm (D) x 111 mm (H)	
Weight	4.5 Kg (incl. CPU, GPU, memory and HDD)	
Mounting	Wall-mount (standard) or DIN-rail mount (optional)	
Environmental		
Operating Temperature	with 35W CPU -25°C ~ 60°C *** with 65W CPU -25°C ~ 60°C **/ *** (configured as 35W TDP mode) -25°C ~ 50°C **/ *** (configured as 65W TDP mode) In compliance with NVIDIA® Tesla T4 warranty policy, an operating temperature of 0°C~50°C is required for systems with Tesla T4 installed	
Storage Temperature	-40°C ~ 85°C	
Humidity	10%~90% , non-condensing	
Vibration	Operating, MIL-STD-810G, Method 514.6, Category 4	
Shock	Operating, MIL-STD-810G, Method 516.6, Procedure I, Table 516.6-II	
EMC	CE/FCC Class A, according to EN 55032 & EN 55024	

* For i7-9700E and i7-8700 running at 65W mode, the highest operating temperature shall be limited to 50°C and thermal throttling may occur when sustained full-loading applied. Users can configure CPU power in BIOS to obtain higher operating temperature.

** For sub-zero operating temperature, a wide temperature HDD or Solid State Disk (SSD) is required.

Appearance

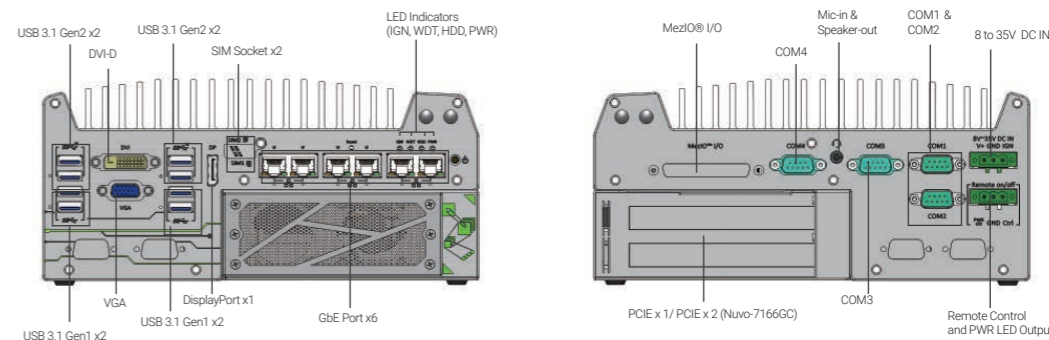

Dimensions

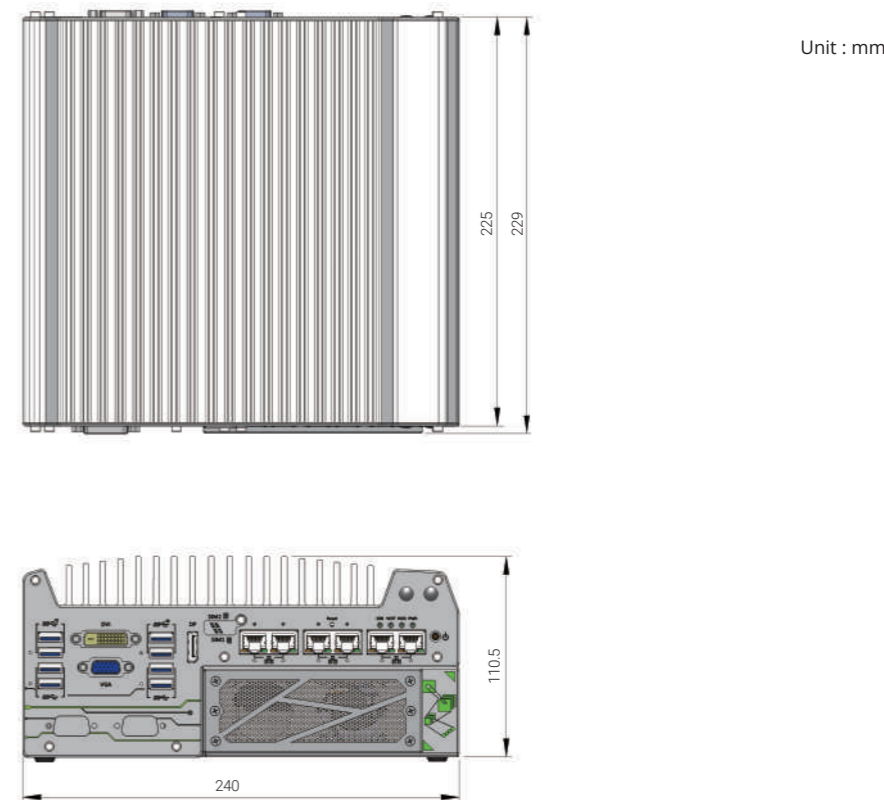

Ordering Information

Model No.	Product Description
Nuvo-7164GC	Intel® 9th/ 8th-Gen Core™ AI inference platform with 6x GbE and MeziO®, supporting NVIDIA® Tesla T4 GPU
Nuvo-7166GC	Intel® 9th/ 8th-Gen Core™ AI inference platform with 6x GbE and MeziO®, supporting NVIDIA® Tesla T4 GPU and one additional PCIe x16 slot

Optional IEEE 802.3at PoE+ for GbE ports 3 ~ 6

Optional Accessories

PA-280W-ET2	280W AC/DC power adapter 24V/11.67A; 16AWG/100cm; cord end terminals for terminal block, operating temperature : -30°C to 60°C.	
Damping bracket	Neosys' patented damping brackets assembly for Nuvo-7160GC/ Nuvo-7164GC/ Nuvo-7166GC	
MeziO® Modules		
MeziO®-C180	MeziO® module with 4x RS-232/ 422/ 485 ports and 4x RS-232 ports	MeziO®-V20-EP MeziO® module with ignition power control function for in-vehicle application
MeziO®-C181	MeziO® module with 4x RS-232/ 422/ 485 ports and 4x RS-422/ 485 ports	MeziO®-U4 MeziO® module with 4x USB 3.1 ports
MeziO®-D220	MeziO® module with 8-CH isolated digital input and 8-CH isolated digital output	MeziO®-G4 MeziO® module with 4x GigE ports
MeziO®-D230	MeziO® module with 16-CH isolated digital input and 16-CH isolated digital output	MeziO®-G4P MeziO® module with 4x IEEE 802.3at PoE ports

Only Nuvo-7164GC-PoE and Nuvo-7166GC-PoE support MeziO-G4P

Nuvo-7160GC Series

Ruggedized GPU-Computing Platform Supporting 120W NVIDIA® GPU and Intel® 9th/8th-Gen Core™ Processor



CE FC

Key Features

- Supports NVIDIA® GPU graphics card up to 120W TDP
- Patented thermal design to allow -25°C to 60°C* wide temperature operation
- Intel® 9th/ 8th-Gen Core™ hexa-core 65W/ 35W LGA1151 CPU
- 6x GigE ports, supporting 9.5 KB jumbo frame
- M.2 2280 M key socket (Gen3 x4) supporting NVMe SSD or Intel® Optane™ memory
- 4x USB 3.1 Gen2 ports and 4x USB 3.1 Gen1 ports
- Accommodates two 2.5" SATA HDD/ SSD with RAID 0/ 1 support
- Compatible with MeziO® interface for function expansion
- Patented ventilation design* for graphics card

*R.O.C Patent No. M534371/ M456527

Introduction

Nuvo-7160GC is a ruggedized GPU-aided edge computer designed for modern machine learning applications such as autonomous driving, facial recognition and machine vision. It supports up to a 120W GPU, delivering 4-6 TFLOPS computing power for inference, as well as Intel® 9th/ 8th-Gen Core™ 6-core/ 8-core CPU, offering up to 50% CPU performance enhancement over previous generations.

Thanks to Neosys' patented Cassette design and ingenious ventilation mechanism, Nuvo-7160GC can effectively dissipate the heat generated by the GPU. By introducing the guided airflow from intake to exhaust with powerful fans featuring smart fan control, it allows a 120W GPU to operate at 60°C ambient temperature under 100% GPU loading.

Nuvo-7160GC incorporates rich I/O functions such as USB 3.1 Gen2/ Gen1, GbE, COM and MeziO® interface in its restricted footprint. It also leverages cutting-edge M.2 NVMe SSD technology for over 2000MB/s disk read/ write speed or Intel® Optane™ memory for the ultimate system acceleration. Neosys Nuvo-7160GC is the ideal solution for emerging edge computing by combining exceptional CPU and GPU performances.

Specifications

System Core		Internal Expansion Bus	
Processor	Supporting Intel® 9th/ 8th-Gen CPU (LGA1151 socket, 65W/ 35W TDP) - Intel® Core™ i7-8700/ i7-8700T/ i7-9700E/ i7-9700TE - Intel® Core™ i5-8500/ i5-8500T/ i5-9500E/ i5-9500TE - Intel® Core™ i3-8100/ i3-8100T/ i3-9100E/ i3-9100TE	PCI/PCI Express	1x PCIe x16 slot@Gen3, 16-lanes PCIe signals in Cassette for installing an NVIDIA® graphics card up to 120W TDP (Max. graphics card dimension is 188 mm(L) x 121 mm(W), dual slot allocation)
Chipset	Intel® Q370 platform controller hub	Mini PCI Express	1x full-size mini PCI Express socket with internal SIM socket (mux with mSATA)
Graphics	Integrated Intel® UHD graphics 630	M.2	1x M.2 2242 B key socket with dual front-accessible SIM sockets, supporting dual SIM mode with selected M.2 LTE module
Memory	Up to 64 GB DDR4 2666/ 2400 SDRAM (two SODIMM slots)	Expandable I/O	1x MeziO® expansion port for Neosys MeziO® modules
AMT	Supports AMT 12.0	Power Supply	
TPM	Supports TPM 2.0	DC Input	1x 3-pin pluggable terminal block for 8 to 35V DC input
I/O Interface		Remote Ctrl. & LED Output	1x 3-pin pluggable terminal block for remote control and PWR LED output
Ethernet	6x Gigabit Ethernet ports by I219 and 5x I210	Mechanical	
PoE+	Optional IEEE 802.3at PoE+ PSE for Port 3 ~ Port 6 100 W total power budget	Dimension	240 mm (W) x 225 mm (D) x 111 mm (H)
USB 3.1	4x USB 3.1 Gen2 (10 Gbps) ports 4x USB 3.1 Gen1 (5 Gbps) ports	Weight	4.5 Kg
Video Port (Integrated Graphics)	1x VGA, supporting 1920 x 1200 resolution 1x DVI-D, supporting 1920 x 1200 resolution 1x DisplayPort, supporting 4096 x 2304 resolution	Mounting	Wall-mount (standard) or DIN-rail mount (optional)
Serial Port	2x software-programmable RS-232/422/485 ports (COM1/ COM2) 2x RS-232 ports (COM3/ COM4)	Environmental	
Audio	1x 3.5 mm jack for mic-in and speaker-out	Operating Temperature	With 35W CPU and 120W GPU -25°C ~ 60°C ** With 65W CPU and 120W GPU -25°C ~ 60°C **/*** (configured as 35W TDP) -25°C ~ 50°C **/*** (configured as 65W TDP)
Storage Interface		Storage Temperature	-40°C ~ 85°C
SATA HDD	2x internal SATA port for 2.5" HDD/ SSD installation, supporting RAID 0/ 1	Humidity	10%~90% , non-condensing
M.2	1x M.2 2280 M key socket (PCIe Gen3 x4) for NVMe SSD or Intel® Optane™ memory installation	Vibration	Operating, MIL-STD-810G, Method 514.6, Category 4
mSATA	1x full-size mSATA port (mux with mini-PCIe)	Shock	Operating, MIL-STD-810G, Method 516.6, Procedure I, Table 516.6-II
		Safety	EN62368-1
		EMC	CE/FCC Class A, according to EN 55032 & EN 55024

* For i7-9700E and i7-8700 running at 65W mode, the highest operating temperature shall be limited to 50°C and thermal throttling may occur when sustained full-loading applied. Users can configure CPU power in BIOS to obtain higher operating temperature.

** For sub-zero operating temperature, a wide temperature HDD or Solid State Disk (SSD) is required.

Appearance

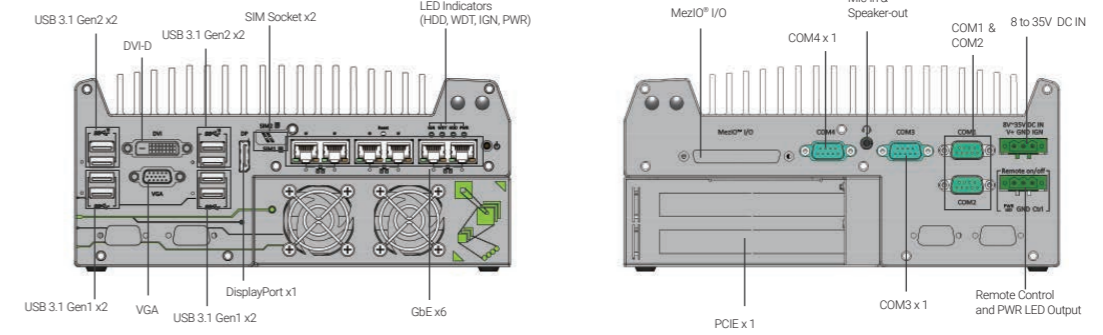

Dimensions

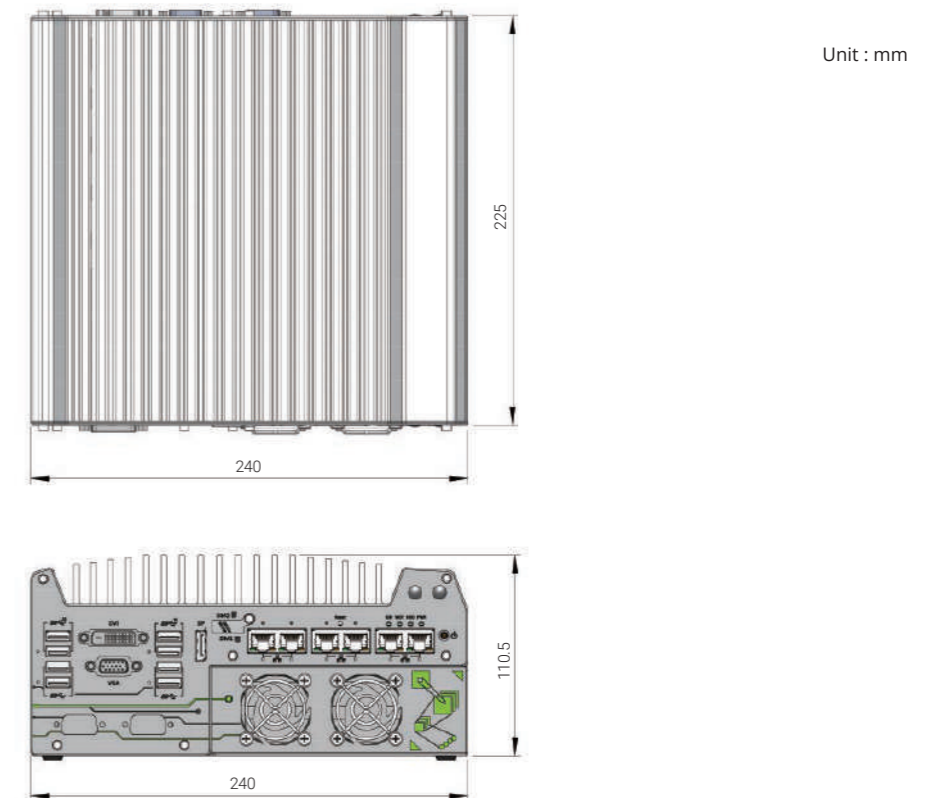

Ordering Information

Model No.	Product Description
Nuvo-7160GC	Intel® 9th/8th-Gen Core™ GPU-computing platform with 6x GbE and MeziO® interface, supporting selected NVIDIA® 120W GPU
Optional IEEE 802.3at PoE+ for GbE ports 3 ~ 6	

Optional Accessories

PA-280W-ET2	280W AC/DC power adapter 24V/11.67A; 16AWG/100cm; cord end terminals for terminal block, operating temperature : -30°C to 60°C.
Damping bracket	Neosys' patented damping brackets assembly for Nuvo-7160GC/ Nuvo-7164GC
MeziO® Modules	
MeziO®-C180	MeziO® module with 4x RS-232/ 422/ 485 ports and 4x RS-232 ports
MeziO®-C181	MeziO® module with 4x RS-232/ 422/ 485 ports and 4x RS-422/ 485 ports
MeziO®-D220	MeziO® module with 8-CH isolated digital input and 8-CH isolated digital output
MeziO®-D230	MeziO® module with 16-CH isolated digital input and 16-CH isolated digital output
MeziO-V20-EP	MeziO® module with ignition power control function for in-vehicle application
MeziO-U4	MeziO® module with 4x USB 3.1 ports
MeziO-G4	MeziO® module with 4x GigE ports
MeziO-G4P	MeziO® module with 4x IEEE 802.3at PoE ports

Only Nuvo-7160-PoE support MeziO-G4P

Nuvo-5095GC Series

Compact and Wide Temperature GPU-Computing Platform
Supporting 75W NVIDIA® GPU and Intel® 6th-Gen Core™ Processor

Key Features

- Supports NVIDIA® GPU with up to 75W TDP
- Patented thermal design to allow -25°C to 60°C Wide temperature system operation
- Supports Intel® 6th-Gen Core™ i7/i5 LGA1151 CPU
- 6x GigE ports, supporting 9.5 KB jumbo frame
- Up to 32 GB, DDR4-2133 SODIMM
- 240 x 225 x 111 mm compact footprint
- Compatible with MeziO® interface for function expansion
- Accommodates two 2.5" SATA HDD/ SSD with RAID 0/1 support
- Patented ventilation* for graphics card



CE FC

*R.O.C Patent No. M534371 / M456527

Introduction

Nuvo-5095GC opens a new chapter for industrial computers. As the first embedded controller targeted at emerging applications of CUDA computing, autopilot, deep learning and virtual reality, Nuvo-5095GC integrates all features required for a compact, reliable and powerful GPU computing platform.

Supporting 75W NVIDIA® GPU (e.g. GTX 1050 Ti), Nuvo-5095GC possesses 768 CUDA cores to deliver tremendous computing power for arithmetic/graphics operations. Neosys' patented Cassette technology and innovative thermal design help to effectively dissipate the heat generated by the GPU, thus making this compact system capable of operating reliably at 60°C with 100% GPU loading.

Nuvo-5095GC is based on Intel® Skylake platform that supports 35W/ 65W 6th-Gen Core™ processors and up to 32GB DDR4 memory. It offers rich I/O functions, such as GbE, USB 3.1 and COM ports to connect to external devices. All these extraordinary features are integrated into a very compact, 240 x 225 x 111 mm footprint. For fast-growing GPU-computing applications, Nuvo-5095GC presents the first industrial-grade, compact and rugged platform incorporating CPU and GPU to offer performance far beyond traditional industrial computers.

Specifications

System Core		Expansion Bus	
Processor	Supports Intel® 6th-Gen Core™ LGA1151 CPU - Intel® Core™ i7-6700 (8M Cache, 3.4/4.0 GHz, 65W TDP) - Intel® Core™ i5-6500 (6M Cache, 3.2/3.6 GHz, 65W TDP) - Intel® Core™ i7-6700TE (8M Cache, 2.4/3.4 GHz, 35W TDP) - Intel® Core™ i5-6500TE (6M Cache, 2.3/3.3 GHz, 35W TDP)	Mini PCI-E	1x internal mini PCI Express socket with front-accessible SIM socket 1x internal mini PCI Express socket with internal SIM socket (mux with mSATA)
Chipset	Intel® Q170 platform controller hub	Expandable I/O	1x MeziO® expansion port for Neosys' MeziO® modules
Graphics	Independent NVIDIA® GPU (75W TDP) or integrated Intel® HD 530/510 controller	Power Supply	
Memory	Up to 32 GB DDR4-2133 SDRAM (two SODIMM slots)	DC Input	1x 3-pin pluggable terminal block for 8 to 35V DC input
AMT	Supports AMT 11.0	Remote Ctrl. & Status Output	1x 10-pin (2x5) wafer connector for remote on/off control and status LED output
TPM	Supports TPM 2.0	Mechanical	
I/O Interface		Dimension	240 mm (W) x 225 mm (D) x 111 mm (H)
Ethernet	6x Gigabit Ethernet ports by Intel® 1x I219 and 5x I210	Weight	4.5 kg (incl. CPU, GPU, memory and HDD)
PoE+	Optional IEEE 802.3at PoE+ PSE for GbE Port 3 ~ Port 6, 80 W total power budget	Mounting	Wall-mount (standard) or DIN-rail mount (optional)
USB 3.1	4x USB 3.1 ports via native XHCI controller	Environmental	
USB 2.0	4x USB 2.0 ports	Operating Temperature	with i7-6700TE, i5-6500TE (35W TDP) -25°C ~ 60°C ** with i7-6700, i5-6500 (65W TDP) -25°C ~ 60°C **/** (configured as 35W CPU mode) -25°C ~ 50°C **/** (configured as 65W CPU mode)
Video Port (Integrated Graphics)	1x stacked VGA + DVI-D 2x DisplayPorts, supporting 4K2K resolution	Storage Temperature	-40°C ~ 85°C
Serial Port	2x software-programmable RS-232/422/485 port (COM1 & COM3) 1x RS-232 port (COM2)	Humidity	10%~90% , non-condensing
Audio	1x mic-in and 1x Speaker-out	Vibration	Operating, 5 Grms, 5-500 Hz, 3 Axes (w/ SSD, according to IEC60068-2-64)
Storage Interface		Shock	Operating, 50 Grms, Half-sine 11 ms Duration (w/ SSD, according to IEC60068-2-27)
SATA HDD	2x internal SATA port for 2.5" HDD/ SSD installation, supporting RAID 0/1	EMC	CE/ FCC Class A, according to EN 55022, EN 55024 & EN 55032
mSATA	1x full-size mSATA port (mux with mini-PCIe)	* For i7-6700 running at 65W mode, the highest operating temperature shall be limited to 50°C and thermal throttling may occur when sustained full-loading applied. Users can configure CPU power in BIOS to obtain higher operating temperature. ** For sub-zero operating temperature, a wide temperature HDD drive or Solid State Disk (SSD) is required.	
Expansion Bus			
PCI/PCI Express	1x PCIe x16 slot @ Gen3, 8-lanes PCIe signals in Cassette for installing 75W NVIDIA® GPU		

* For i7-6700 running at 65W mode, the highest operating temperature shall be limited to 50°C and thermal throttling may occur when sustained full-loading applied. Users can configure CPU power in BIOS to obtain higher operating temperature.
** For sub-zero operating temperature, a wide temperature HDD drive or Solid State Disk (SSD) is required.

Appearance

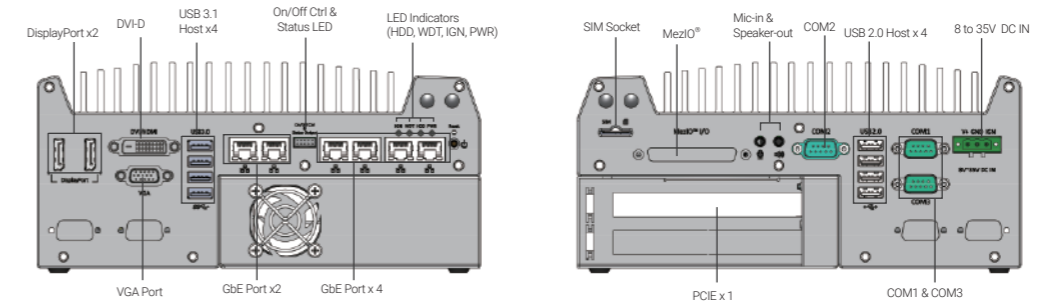

Dimensions

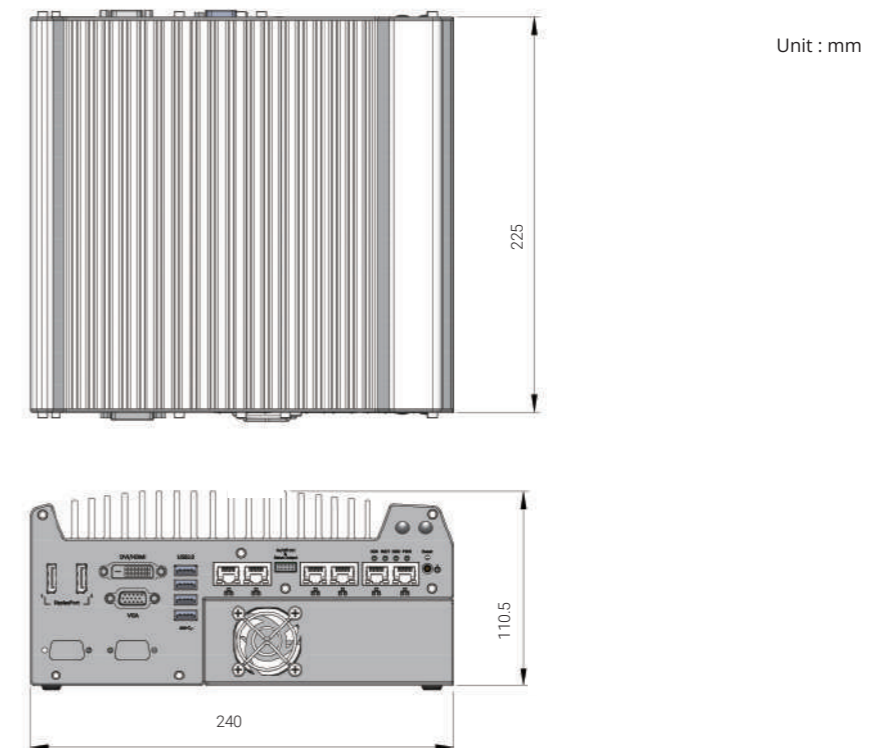

Ordering Information

Model No.	Product Description
Nuvo-5095GC	Intel® 6th-Gen Core™ GPU-computing platform with 6x GbE and MeziO™ interface, supporting selected 75W NVIDIA® GPU
Optional IEEE 802.3at PoE+ for GbE ports 3 ~ 6	

Optional Accessories

PA-160W-OW	160W AC/DC power adapter 20V/8A; 18AWGx4C/120cm, cord end terminals for terminal block, operating temperature : -30 to 70 °C.		
MeziO® Modules			
MeziO®-C180	MeziO® module with 4x RS-232/ 422/ 485 ports and 4x RS-232 ports	MeziO-V20-EP	MeziO® module with ignition power control function for in-vehicle application
MeziO®-C181	MeziO® module with 4x RS-232/ 422/ 485 ports and 4x RS-422/ 485 ports	MeziO-U4	MeziO® module with 4x USB 3.1 ports
MeziO®-D220	MeziO® module with 8-CH isolated digital input and 8-CH isolated digital output	MeziO-G4	MeziO® module with 4x GigE ports
MeziO®-D230	MeziO® module with 16-CH isolated digital input and 16-CH isolated digital output	MeziO-G4P	MeziO® module with 4x IEEE 802.3at PoE ports

Only Nuvo-5095GC-PoE supports MeziO-G4P



SEMI.™



SEMIL-1700GC Series

IP67 Waterproof GPU Computer supporting NVIDIA® RTX A2000/ Tesla T4/ Quadro P2200 and Intel® Xeon® E or 9th/ 8th-Gen Core™ CPU with All M12 Connectors



Key Features

- IP67 waterproof GPU computer with NVIDIA® RTX A2000/ Tesla T4/ Quadro P2200
- Intel® Xeon® E or 9th/ 8th-Gen Core™ i7/ i5/ i3 CPU
- Patented waterproof 2U 19" chassis for rack or wall-mount*
- Guaranteed non-throttling GPU performance up to 62°C ambient
- Up to eight 802.3at Gigabit PoE+ ports via M12 X-coded connectors
- VGA, USB 2.0 and COM ports via M12 A-coded connectors
- 8 to 48V wide-range DC input with built-in ignition power control
- MIL-STD-810G and EN 50155 certified



*R.O.C Patent No. 1697759
*CN Patent Pending

Introduction

SEMIL-1700GC series is one of the world's first IP67-rated, waterproof and dustproof inference server with pre-installed NVIDIA® RTX A2000, Tesla T4 or Quadro P2200 for the most demanding environments. It is a brand new page in Neousys' chapter of innovations as it represents a new level of robustness for rugged edge AI solutions. Coupled with Intel® Xeon® E or 9th/ 8th-Gen Core™ CPU, the system delivers excellent CPU and GPU performances for advanced edge AI applications in various environmental settings. SEMIL-1700GC series features Neousys' patented system architecture* to guarantee -40°C to 70°C fanless operation in a rack or wall-mountable 2U 19" enclosure.

SEMIL-1700GC series features a sophisticated thermal design to dissipate the heat generated by RTX A2000, Tesla T4 or Quadro P2200 GPU to ensure maximum GPU performance in high-temperature environments. It has a corrosion-proof, stainless steel/ aluminum chassis with molded o-rings plus patented fusion mechanism design to offer extraordinary durability and watertight construction. SEMIL-1700GC series offers a variety of I/O connectivities, including 802.3at Gigabit PoE+, VGA, USB, COM ports and optional 10G Ethernet, all using M12 connectors for water-proof and extreme-rugged connectivity in shock and vibration conditions. Additionally, it features M.2 for NVMe SSD, 2.5" SATA storage accommodation, 8 to 48V wide-range DC input with ignition power control and complies with MIL-STD-810G and EN 50155.

The inference acceleration of rugged GPU computers actualized real-time AI inference applications at the edge, where extremely rough conditions are expected. By combining powerful CPU/ GPU, robust IP67 protection, true fanless wide-temperature operation, rugged M12 connectors, and standard 2U 19" rack, SEMIL-1700GC series reveals unprecedented possibilities of deploying AI to places that have yet to be reached.

Specifications

	SEMIL-1744GC	SEMIL-1724GC	SEMIL-1748GC	SEMIL-1728GC
System Core	SEMIL-1744GC SEMIL-1724GC SEMIL-1748GC SEMIL-1728GC			
Processor	Supporting Intel® Xeon® E and 9th/ 8th-Gen CPU (LGA1151 socket) - Xeon E 2278GE (8C/16T) / 2278GEL (8C/16T) / 2176G (6C/12T) - i7-9700E, i7-9700TE, i7-8700, i7-8700T - i5-9500E, i5-9500TE, i5-8500, i5-8500T - i3-9100E, i3-9100TE, i3-8100, i3-8100T			
Chipset	Intel® C246 platform controller hub			
Graphics	Integrated Intel® UHD Graphics 630			
Acceleration GPU	NVIDIA® Tesla T4	NVIDIA® RTX A2000/ Quadro P2200	NVIDIA® Tesla T4	NVIDIA® RTX A2000/ Quadro P2200
Memory	Up to 64 GB ECC/ non-ECC DDR4-2666/ 2400 SDRAM (two SODIMM sockets)			
AMT	Supports AMT 12.0			
TPM	Supports TPM 2.0			
I/O Interface	SEMIL-1744GC SEMIL-1724GC SEMIL-1748GC SEMIL-1728GC			
PoE+	1x IEEE 802.3at (25.5W) Gigabit PoE+ ports by Intel® I219 (M12 X-coded)		7x IEEE 802.3at (25.5W) Gigabit PoE+ ports by Intel® I210 (M12 X-coded)	
10 GbE Port (Build Option)	Optional: 1x 10 GbE port by Intel® X550AT controller (M12 X-coded)**			
Native Video Port	1x VGA (M12 A-coded), supporting 1920 x 1200 resolution			
Series Port	2x 3-wires RS-232 ports COM1 & COM2 (M12 A-coded)			
USB	2x USB 2.0 (M12 A-coded) 1x USB 2.0 (internal)		4x USB 2.0 (M12 A-coded) 1x USB 2.0 (internal)	
Audio	1x mic-in and speaker-out (M12 A-coded)			
Storage Interface	SEMIL-1744GC SEMIL-1724GC SEMIL-1748GC SEMIL-1728GC			
SATA HDD	2x Internal SATA port for 2.5" HDD/ SSD installation, supporting RAID 0/ 1			
mSATA	2x full-size mSATA port (mux with mini-PCIe)			
M.2	1x M.2 2280 M key socket (PCIe Gen3 x4) for NVMe SSD or Intel® Optane™ memory installation			
Expansion Bus	SEMIL-1744GC SEMIL-1724GC SEMIL-1748GC SEMIL-1728GC			
Mini PCI-E	2x full-size mini PCI Express sockets (mux with mSATA)		2x full-size mini PCI Express socket (mux with mSATA) 2x full-size mini PCI Express socket	
Power Supply	SEMIL-1744GC SEMIL-1724GC SEMIL-1748GC SEMIL-1728GC			
DC Input	8 to 48V DC input (M12 S-coded)			
Ignition Control	Built-in ignition power control (IGN/ GND signal via M12 serial port connector)			
Mechanical	SEMIL-1744GC SEMIL-1724GC SEMIL-1748GC SEMIL-1728GC			
Dimension	440mm (W) x 310mm (D) x 90.5mm (H) (excl. rack-mount bracket)			
Weight	12 kg		12.2 kg	
Mounting	Rack-mounting and wall-mounting			
Environmental	SEMIL-1744GC SEMIL-1724GC SEMIL-1748GC SEMIL-1728GC			
Operating Temperature	with 35W CPU -40°C ~ 70°C **** with >= 65W CPU -40°C ~ 70°C ***/ ***** (configured as 35W TDP mode) -40°C ~ 50°C ***/ ***** (configured as 65W TDP mode)			
Storage Temperature	-40°C ~ 85°C			
Humidity	10%~90% , non-condensing			
Vibration	MIL-STD-810G, Method 514.7, Category 4			
Shock	MIL-STD-810G, Method 516.7, Procedure I			
EMC	EN-50155, CE/FCC Class A, according to EN 55032 & EN 55035			

** For optional 10GbE support, please contact Neousys Technology
*** For Xeon E 2176G/ 2278GE, i7-9700E, and i7-8700 running at 65W mode, the highest operating temperature shall be limited to 50°C and thermal throttling may occur when sustained full-loading applied. Users can configure CPU power in BIOS to obtain higher operating temperature.
**** For sub-zero operating temperature, a wide temperature HDD or Solid State Disk (SSD) is required

Appearance

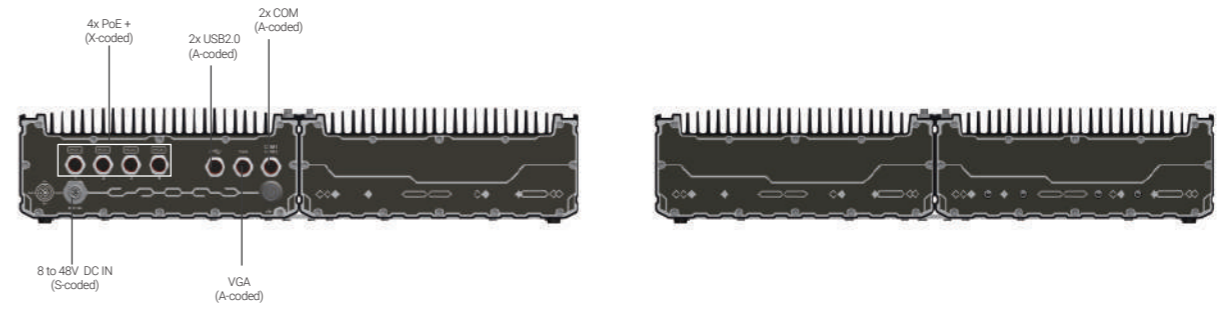

Dimensions

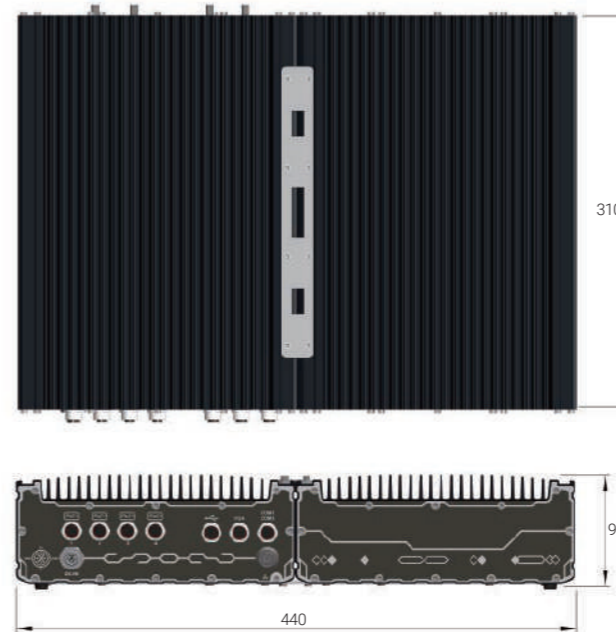

Unit : mm

Mounting Configuration



▲ SEMIL 19" rack-mounted

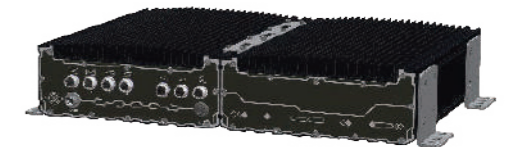

▲ SEMIL wall-mounted

Ordering Information

Model No.	Product Description
SEMIL-1744GC	IP67 Waterproof GPU Computer supporting NVIDIA® Tesla T4 and Intel® Xeon® E or 9th/ 8th-Gen Core™ CPU with 4x M12 PoE+ ports
SEMIL-1724GC	IP67 waterproof GPU computer supporting NVIDIA® Quadro P2200 and Intel® Xeon® E or 9th/ 8th-Gen Core™ CPU with 4x M12 PoE+ ports
SEMIL-1724GC-A2K	IP67 waterproof GPU computer supporting NVIDIA® RTX A2000 and Intel® Xeon® E or 9th/ 8th-Gen Core™ CPU with 4x M12 PoE+ ports
SEMIL-1748GC	IP67 waterproof GPU computer supporting NVIDIA® Tesla T4 and Intel® Xeon® E or 9th/ 8th-Gen Core™ CPU with 8x M12 PoE+ ports
SEMIL-1728GC	IP67 Waterproof GPU Computer supporting NVIDIA® Quadro P2200 and Intel® Xeon® E or 9th/ 8th-Gen Core™ CPU with 8x M12 PoE+ ports
SEMIL-1728GC-A2K	IP67 Waterproof GPU Computer supporting NVIDIA® RTX A2000 and Intel® Xeon® E or 9th/ 8th-Gen Core™ CPU with 8x M12 PoE+ ports

Optional Accessories

M12-Cable-Kit	4x PoE+, VGA, 2x USB2.0 (by Y-cable), 2x COM (by Y-cable) and DC power cables
PA-280W-ET2	280W AC/DC power adapter 24V/11.67A; 16AWG/100cm; cord end terminals for terminal block, operating temperature : -30°C to 60°C

SEMIL-1700 Series

Half-rack IP67 Waterproof Computer Supporting Intel® Xeon® E or 9th/ 8th-Gen Core™ Processor with All M12 Connectors



Key Features

- Intel® Xeon® E or 9th/ 8th-Gen Core™ i7/ i5/ i3 CPU
- Extremely rugged, IP67-rated waterproof and dustproof
- -40°C to 70°C wide-temperature fanless operation
- 2U 19" half-rack form-factor for rack or wall-mount
- Up to 8x 802.3at Gigabit PoE+ ports via M12 X-coded connectors
- VGA, USB 2.0 and COM ports via M12 A-coded connectors
- Patented SuperCAP-based uninterruptible power backup* (SEMIL-1710J)
- 8 to 48V wide-range DC input with built-in ignition power control
- MIL-STD-810G and EN 50155 certified



*R.O.C Patent No. 1598820

Introduction

SEMIL-1700 series is an extremely rugged 2U half-rack computer with an IP67-rated waterproof and dustproof design. Powered by Intel® Xeon® E or 9th/ 8th-Gen Core™ CPU and coupled with workstation-grade Intel® C246 chipset, it can support up to 64 GB ECC/ non-ECC DDR4 memory. The 2U half-rack form-factor SEMIL-1700 series incorporates Neosys' best-in-class thermal design and offers mounting flexibility where you can wall or rack-mount up to two SEMILs side by side.

SEMIL-1700 adopts a corrosion-proof chassis made of stainless steel and aluminum to counteract against moisture and salinity. Offering a variety of I/O connectivities that utilize M12 connectors to guarantee extremely rugged connections in shock and vibration environments, it has up to eight 802.3at PoE+ ports to supply 25W of power to connected devices. Internal expansion wise, it has an M.2 M-key socket to support NVMe SSD and mini-PCIe sockets for extending feature sets. Additionally, SEMIL-1700 features two 2.5" SATA HDD/ HDD accommodation, 8 to 48V wide-range DC input with ignition power control and complies with MIL-STD-810G and EN 50155.

To top it off, SEMIL-1710J is equipped with Neosys' innovative SuperCAP-based UPS* containing 2500 watt-second stored energy to sustain or safely shut down the system during unforeseen power outages. Protected against water, dust, high/ low temperature, shock/ vibration and power interruption, Neosys' SEMIL-1700 series is set to redefine edge application computing, where ruggedness matter.

Specifications

	SEMIL-1704	SEMIL-1714J	SEMIL-1708	SEMIL-1718J
System Core				
Processor	Supporting Intel® Xeon® E and 9th/ 8th-Gen CPU (LGA1151 socket) - Xeon E 2278GE (8C/16T) / 2278GEL (8C/16T) / 2176G (6C/12T) - i7-9700E, i7-9700TE, i7-8700, i7-8700T - i5-9500E, i5-9500TE, i5-8500, i5-8500T - i3-9100E, i3-9100TE, i3-8100, i3-8100T			
Chipset	Intel® C246 platform controller hub			
Graphics	Integrated Intel® UHD Graphics 630			
Memory	Up to 64 GB ECC/ non-ECC DDR4-2666/ 2400 SDRAM (two SODIMM sockets)			
AMT	Supports AMT 12.0			
TPM	Supports TPM 2.0			
I/O Interface				
PoE+	1x IEEE 802.3at (25.5W) Gigabit PoE+ ports by Intel® I219 (M12 X-coded)	3x IEEE 802.3at (25.5W) Gigabit PoE+ ports by Intel® I210 (M12 X-coded)	7x IEEE 802.3at (25.5W) Gigabit PoE+ ports by Intel® I210 (M12 X-coded)	
10 GbE Port (Build Option)	Optional: 1x 10 GbE port by Intel® X550AT controller (M12 X-coded)**			
Native Video Port	1x VGA (M12 A-coded), supporting 1920 x 1200 resolution			
Series Port	2x 3-wires RS-232 ports COM1 & COM2 (M12 A-coded)			
USB	2x USB 2.0 (M12 A-coded) 1x USB 2.0 (internal)	4x USB 2.0 (M12 A-coded) 1x USB 2.0 (internal)		
Audio	1x mic-in and speaker-out (M12 A-coded)			
Storage Interface				
SATA HDD	2x Internal SATA port for 2.5" HDD/ SSD installation, supporting RAID 0/ 1			
mSATA	2x full-size mSATA port (mux with mini-PCIe)			
M.2	1x M.2 2280 M key socket (PCIe Gen3 x4) for NVMe SSD or Intel® Optane™ memory installation			
Expansion Bus				
Mini PCI-E	2x full-size mini PCI Express socket (mux with mSATA)	2x full-size mini PCI Express socket (mux with mSATA)		2x full-size mini PCI Express socket
Power Supply				
DC Input	8 to 48V DC input (M12 S-coded)			
Ignition Control	Built-in ignition power control (IGN/ GND signal via M12 serial port connector)			
SuperCAP UPS				
Capacity	-	2500 watt-second	-	2500 watt-second
Mechanical				
Dimension	220mm (W) x 310mm (D) x 90.5mm (H)			
Weight	5.8 kg	6 kg	5.9 kg	6.2 kg
Mounting	Rack-mounting and wall-mounting			
Environmental				
Operating Temperature	with 35W CPU -40°C ~ 70°C **** with >= 65W CPU -40°C ~ 70°C ***/ **** (configured as 35W TDP mode) -40°C ~ 50°C ***/ **** (configured as 65W TDP mode)			
Storage Temperature	-40°C ~85°C			
Humidity	10%~90%, non-condensing			
Vibration	MIL-STD-810G, Method 514.7, Category 4			
Shock	MIL-STD-810G, Method 516.7, Procedure I			
EMC	EN-50155, CE/FCC Class A, according to EN 55032 & EN 55035			

** For optional 10GbE support, please contact Neosys Technology
*** For Xeon E 2176G/ 2278GE, i7-9700E, and i7-8700 running at 65W mode, the highest operating temperature shall be limited to 50°C and thermal throttling may occur when sustained full-loading applied. Users can configure CPU power in BIOS to obtain higher operating temperature.
**** For sub-zero operating temperature, a wide temperature HDD or Solid State Disk (SSD) is required

Appearance

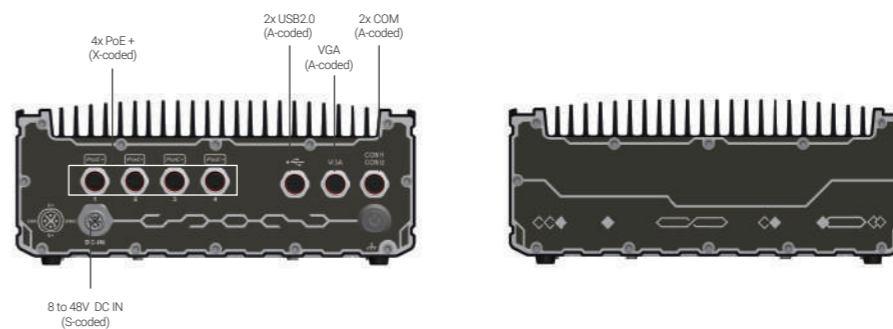

Dimensions

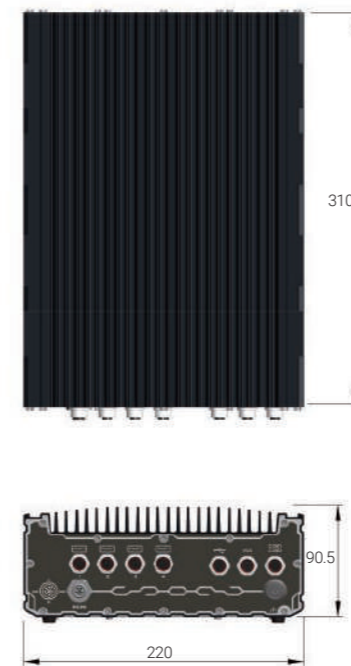

Unit : mm

Mounting Configuration



▲ Dual SEMIL 19" rack-mounted



▲ Dual SEMIL 19" wall-mounted



▲ SEMIL wall-mounted

Ordering Information

Model No.	Product Description
SEMIL-1704	Half-rack IP67 waterproof computer supporting Intel® Xeon® E or 9th / 8th-Gen Core™ processor with 4x M12 PoE+ ports
SEMIL-1714J	Half-rack IP67 waterproof computer supporting Intel® Xeon® E or 9th / 8th-Gen Core™ processor with 4x M12 PoE+ ports and SuperCAP UPS
SEMIL-1708	Half-rack IP67 waterproof computer supporting Intel® Xeon® E or 9th / 8th-Gen Core™ processor with 8x M12 PoE+ ports
SEMIL-1718J	Half-rack IP67 waterproof computer supporting Intel® Xeon® E or 9th / 8th-Gen Core™ processor with 8x M12 PoE+ ports and SuperCAP UPS

Optional Accessories

Joint-plate	Joint plate for dual SEMIL assembly
M12-Cable-Kit	4x PoE+, VGA, 2x USB2.0 (by Y-cable), 2x COM (by Y-cable) and DC power cables
PA-160W-OW	160W AC-DC power adapter, 20V/8A; 18AWG/120cm; cord end terminals for terminal block, operating temperature : -30 to 70°C.
PA-120W-OW	120W AC/DC power adapter, 20V/6A; 18AWG/120cm; cord end terminals for terminal block, operating temperature : -30 to 70°C.

SEMIL-1300GC Series

Wide-temperature Fanless GPU Computer supporting NVIDIA® RTX A2000/ Tesla T4 GPU/ Quadro P2200 and Intel® Xeon® E or 9th/ 8th-Gen Core™ CPU with M12 connectors



Key Features

- Fanless GPU computer with NVIDIA® RTX A2000/ Tesla T4/ Quadro P2200
- Guaranteed non-throttling GPU performance up to 62°C ambient
- Intel® Xeon® E or 9th/ 8th-Gen Core™ i7/ i5/ i3 CPU
- Patented 2U 19" chassis for rack or wall-mount*
- Four 802.3at Gigabit PoE+ ports via M12 X-coded connectors
- VGA, USB 2.0 and COM ports via M12 A-coded connectors
- 1x DisplayPort and 3x USB 3.1 Gen1 ports
- 8 to 48V wide-range DC input with built-in ignition power control
- CE, FCC and EN 50155 certified



*R.O.C Patent No. 1697759
*CN Patent Pending

Introduction

SEMIL-1300GC series is the world's first wide-temperature fanless edge AI computer supporting NVIDIA® RTX A2000, Tesla T4 or Quadro P2200 for demanding environments. Coupled with Intel® Xeon® E or 9th/ 8th-Gen Core™ CPU, the system delivers excellent CPU and GPU performances for modern edge AI applications. SEMIL-1300GC series features Neosys' patented thermal system architecture* to guarantee -40°C to 70°C fanless operation in a rack-mountable or wall-mountable 2U 19" enclosure.

SEMIL-1300GC series features an advanced passive cooling design to ensure the CPU/ GPU does not throttle when operating in high-temperature environments. Compatible with a RTX A2000, Tesla T4 or Quadro P2200 GPU, users can utilize the scalable GPU performance that offers up to 8.1 TFLOPS in FP32 or 130 TOPS in INT8. The system leverages M12 connectors for Gigabit PoE+, USB 2.0, VGA and COM ports to offer rugged cable connectivity. Other high-speed computer I/Os include DisplayPort, USB 3.1 Gen1, optional 10G Ethernet and storage interfaces such as an M.2 for NVMe SSD and SATA ports, making SEMIL-1300GC expandable and versatile.

The GPU-powered deep learning systems actualized real-time AI inference applications at the edge by thriving in rough conditions. Combining a RTX A2000, Tesla T4 or Quadro P2200, wide-temperature fanless design and rugged M12 connectors, the SEMIL-1300GC series reveals unprecedented possibilities of deploying AI to places that have yet to be reached.

Specifications

	SEMIL-1341GC	SEMIL-1321GC	SEMIL-1341GC	SEMIL-1321GC
System Core				
Processor	Supporting Intel® Xeon® E and 9th/ 8th-Gen CPU (LGA1151 socket) - Xeon E 2278GE (8C/16T) / 2278GEL (8C/16T) / 2176G (6C/12T) - i7-9700E, i7-9700TE, i7-8700, i7-8700T - i5-9500E, i5-9500TE, i5-8500, i5-8500T - i3-9100E, i3-9100TE, i3-8100, i3-8100T		Storage Interface	
Chipset	Intel® C246 platform controller hub		M.2 1x M.2 2280 M key socket (PCIe Gen3 x4) for NVMe SSD or Intel® Optane™ memory installation	
Graphics	Integrated Intel® UHD Graphics 630		Expansion Bus	
Acceleration GPU	NVIDIA® Tesla T4 for AI inference	NVIDIA® RTX A2000/ Quadro P2200 for AI inference	Mini PCI-E 2x full-size mini PCI Express sockets (mux with mSATA) 1x M.2 3042/ 3052 B key socket for selected M.2 4G/ 5G module 1x M.2 2242/ 2252 E key for selected WiFi module	
Memory	Up to 64 GB ECC/ non ECC DDR4-2666/ 2400 SDRAM (two SODIMM sockets)		Power Supply	
AMT	Supports AMT 12.0		DC Input 8 to 48V DC input	
TPM	Supports TPM 2.0		Ignition Control Built-in ignition power control	
I/O Interface				
PoE+	1x IEEE 802.3at (25.5W) Gigabit PoE+ ports by Intel® I219 (M12 X-coded) 3x IEEE 802.3at (25.5W) Gigabit PoE+ ports by Intel® I210 (M12 X-coded)		Mechanical	
10 GbE Port (Build Option)	Optional: 1x 10 GbE port by Intel® X550AT controller (M12 X-coded)**		Dimension 440mm (W) x 310mm (D) x 90.5mm (H) (excl. rack-mount bracket)	
Native Video Port	1x VGA (M12 A-coded), supporting 1920 x 1200 resolution 1x DisplayPort connector, supporting 4096 x 2304 resolution		Weight 12 kg	
Series Port	2x 3-wires RS-232 ports COM1 & COM2 (M12 A-coded) 1x software-programmable RS-232/ 422/ 485 port (COM3, DB9) 1x RS-232 port (COM4, DB9)		Mounting Rack-mounting and wall-mounting	
USB	3x USB 3.1 Gen1 2x USB 2.0 (M12 A-coded) 1x USB 2.0 (internal)		Environmental	
Audio	1x 3.5 mm jack for mic-in and speaker-out		Operating Temperature with 35W CPU -40°C ~ 70°C **** with >= 65W CPU -40°C ~ 70°C ***/ **** (configured as 35W TDP mode) -40°C ~ 50°C **/ ***** (configured as 65W TDP mode)	
Storage Interface				
SATA HDD	2x Internal SATA port for 2.5" HDD/ SSD installation, supporting RAID 0/ 1		Storage Temperature -40°C ~85°C	
mSATA	2x full-size mSATA port (mux with mini-PCIe)		Humidity 10%~90% , non-condensing	
<p>** For optional 10GbE support, please contact Neosys Technology *** For Xeon E 2176G/ 2278GE, i7-9700E, and i7-8700 running at 65W mode, the highest operating temperature shall be limited to 50°C and thermal throttling may occur when sustained full-loading applied. Users can configure CPU power in BIOS to obtain higher operating temperature. **** For sub-zero operating temperature, a wide temperature HDD or Solid State Disk (SSD) is required</p>				

Appearance



Dimensions

Unit : mm

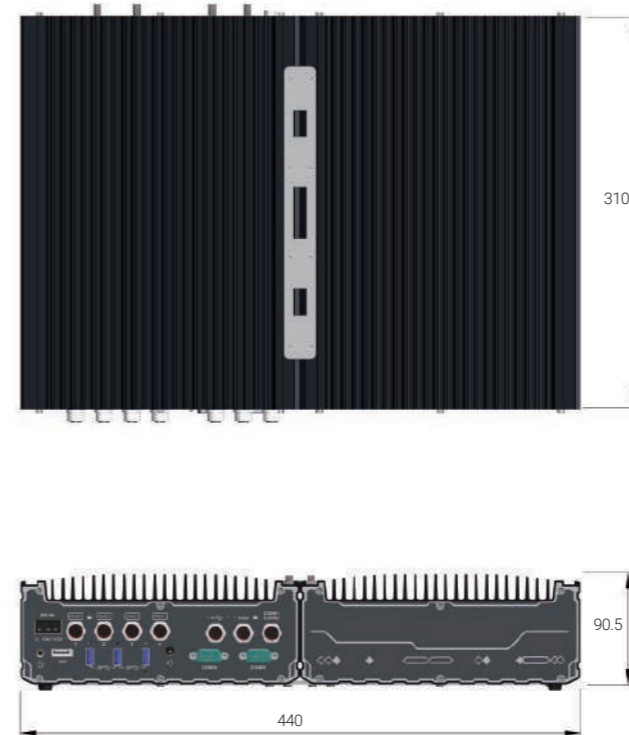

Mounting Configuration



▲ SEMIL 19" rack-mounted



▲ SEMIL wall-mounted

Ordering Information

Model No.	Product Description
SEMIL-1341GC	Wide-temperature fanless GPU computer with NVIDIA® Tesla T4 GPU and Intel® Xeon® E or 9th/ 8th-Gen Core™ CPU with M12 connectors
SEMIL-1321GC	Wide-temperature fanless GPU computer with NVIDIA® Quadro P2200 GPU and Intel® Xeon® E or 9th/ 8th-Gen Core™ CPU with M12 connectors
SEMIL-1321GC-A2K	Wide-temperature fanless GPU computer with NVIDIA® RTX A2000 GPU and Intel® Xeon® E or 9th/ 8th-Gen Core™ CPU with M12 connectors

Optional Accessories

M12-Cable-Kit	4x PoE+, VGA, 2x USB2.0 (by Y-cable), 2x COM (by Y-cable) and DC power cables
PA-280W-ET2	280W AC/ DC power adapter 24V/ 11.67A; 16AWG/ 100cm; cord end terminals for terminal block, operating temperature: -30°C to 60°C.

SEMIL-1300 Series

Half-Rack Rugged Fanless Computer Supporting Intel® Xeon® E or 9th/ 8th-Gen Core™ Processor with M12 connectors



Key Features

- Intel® Xeon® E or 9th/ 8th-Gen Core™ i7/ i5/ i3 CPU
- 2U half-rack fanless system, -40 °C to 70 °C operation
- 4x 802.3at Gigabit PoE+, VGA, 2x USB 2.0, 2x COM via M12 connectors
- M.2 B key for 4G/ 5G module, M.2 E key for WiFi module
- Patented supercapacitor-based uninterruptible power backup* (SEMIL-1311J)
- 8 to 48V wide-range DC input with built-in ignition power control
- CE, FCC and EN 50155 certified



*R.O.C Patent No. 1598820

Introduction

SEMIL-1300 series is a rugged fanless computer with robust M12 I/O connectors in a standard 2U 19" half-rack form factor enclosure. Powered by Intel® Xeon® E or 9th/ 8th-Gen Core™ CPU and coupled with workstation-grade Intel® C246 chipset, it supports up to 64 GB DDR4 ECC/non-ECC memory and offers flexible mounting options to wall or rack-mount up to two SEMILs side by side.

SEMIL-1300 series incorporates Neousys' best-in-class passive thermal design for proven -40 °C to 70 °C fanless operation. It offers a variety of I/O connectivities utilizing M12 connectors that are reliably robust, cost-effective and can be obtained off-the-shelf. There are also generic I/Os with screw-lock mechanisms to guarantee an extreme-rugged connection in shock and vibration environments. It has four 802.3at PoE+ ports, each supplying 25W of power to the connected device such as an IP or GigE camera. SEMIL-1300 is designed with 4G/5G and WiFi5/WiFi6 wireless connectivity in mind and it supports 8 to 48V wide-range DC input with ignition power control for in-vehicle use while complying with EN 50155.

In addition, SEMIL-1311J is equipped with Neousys' patented SuperCAP-based UPS containing 2500 watt-second stored energy to sustain and safely shut down the system during unforeseen power outages. It is the perfect solution for data protection and applications in unstable power environments. With a standard half-rack design, proven wide temperature operation capability, protected against shock/ vibration and power interruption, Neousys' SEMIL-1300 series is the ideal robust solution for extreme-rugged deployment.

Specifications

	SEMIL-1301	SEMIL-1311J		SEMIL-1301	SEMIL-1311J
System Core					
Processor	Supporting Intel® Xeon® E and 9th/ 8th-Gen CPU (LGA1151 socket) - Xeon E 2278GE (8C/16T) / 2278GEL (8C/16T) / 2176G (6C/12T) - i7-9700E, i7-9700TE, i7-8700, i7-8700T - i5-9500E, i5-9500TE, i5-8500, i5-8500T - i3-9100E, i3-9100TE, i3-8100, i3-8100T		Expansion Bus		
Chipset	Intel® C246 platform controller hub		2x full-size mini PCI Express sockets (mux with mSATA)		
Graphics	Integrated Intel® UHD Graphics 630		Mini PCI-E 1x M.2 3042/ 3052 B key socket for selected M.2 4G/ 5G module 1x M.2 2242/ 2252 E key for selected WiFi module		
Memory	Up to 64 GB ECC/ non-ECC DDR4-2666/ 2400 SDRAM (two SODIMM sockets)		Power Supply		
AMT	Supports AMT 12.0		DC Input 8 to 48V DC input		
TPM	Supports TPM 2.0		Ignition Control Built-in ignition power control		
I/O Interface					
PoE+	1x IEEE 802.3at (25.5W) Gigabit PoE+ ports by Intel® I219 (M12 X-coded) 3x IEEE 802.3at (25.5W) Gigabit PoE+ ports by Intel® I210 (M12 X-coded)		Power Backup		
10 GbE Port (Build Option)	Optional: 1x 10 GbE port by Intel® X550AT controller (M12 X-coded)**		Capacity - 2500 watt-second		
Native Video Port	1x VGA (M12 A-coded), supporting 1920 x 1200 resolution 1x DisplayPort connector, supporting 4096 x 2304 resolution		Mechanical		
Series Port	2x 3-wires RS-232 ports COM1 & COM2 (M12 A-coded) 1x software-programmable RS-232/ 422/ 485 port (COM3, DB9) 1x RS-232 port (COM4, DB9)		Dimension 220mm (W) x 310mm (D) x 90.5mm (H) (excl. rack-mount bracket)		
USB	3x USB 3.1 Gen1 2x USB 2.0 (M12 A-coded) 1x USB 2.0 (internal)		Weight 5.8 kg 6 kg		
Audio	1x 3.5 mm jack for mic-in and speaker-out		Mounting Rack-mounting and wall-mounting		
Storage Interface					
SATA HDD	2x Internal SATA port for 2.5" HDD/ SSD installation, supporting RAID 0/ 1		Environmental		
mSATA	2x full-size mSATA port (mux with mini-PCIe)		Operating Temperature with 35W CPU -40°C ~ 70°C **** with >= 65W CPU -40°C ~ 70°C ***/ **** (configured as 35W TDP mode) -40°C ~ 50°C ***/ **** (configured as 65W TDP mode)		
M.2	1x M.2 2280 M key socket (PCIe Gen3 x4) for NVMe SSD or Intel® Optane™ memory installation		Storage Temperature -40°C ~ 85°C		
			Humidity 10%~90% , non-condensing		
			Vibration MIL-STD-810G, Method 514.7, Category 4		
			Shock MIL-STD-810G, Method 516.7, Procedure I		
			EMC EN-50155, CE/FCC Class A, according to EN 55032 & EN 55035		

** For optional 10GbE support, please contact Neousys Technology
*** For Xeon E 2176G/ 2278GE, i7-9700E, and i7-8700 running at 65W mode, the highest operating temperature shall be limited to 50°C and thermal throttling may occur when sustained full-loading applied. Users can configure CPU power in BIOS to obtain higher operating temperature.
**** For sub-zero operating temperature, a wide temperature HDD or Solid State Disk (SSD) is required

Appearance

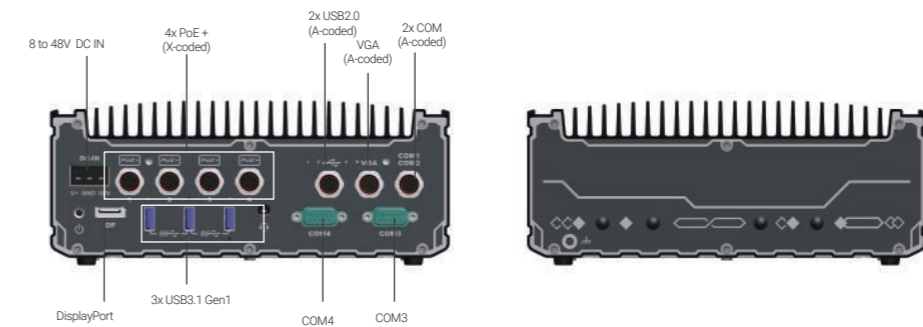

Dimensions

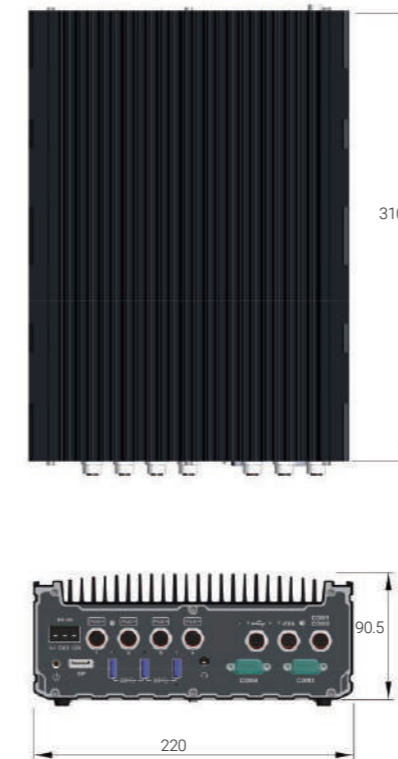

Mounting Configuration

Unit : mm



▲ SEMIL 19" rack-mounted



▲ SEMIL wall-mounted

Ordering Information

Model No.	Product Description
SEMIL-1301	Half-Rack Rugged Fanless Computer supporting Intel® Xeon® E or 9th/ 8th-Gen Core™ processor with M12 I/Os
SEMIL-1311J	Half-Rack Rugged Fanless Computer supporting Intel® Xeon® E or 9th/ 8th-Gen Core™ processor with M12 I/Os and SuperCAP UPS

Optional Accessories

Joint-plate	Joint plate for dual SEMIL assembly
M12-Cable-Kit	4x PoE+, VGA, 2x USB2.0 (by Y-cable), 2x COM (by Y-cable) and DC power cables
PA-160W-OW	160W AC-DC power adapter, 20V/8A; 18AWG/120cm; cord end terminals for terminal block, operating temperature : -30 to 70°C.
PA-120W-OW	120W AC/DC power adapter, 20V/6A; 18AWG/120cm; cord end terminals for terminal block, operating temperature : -30 to 70°C.



Neousys
Mez10™ Modules

MezIO®-C180/ MezIO®-C181 8-port RS-232/ 422/ 485 MezIO® Module

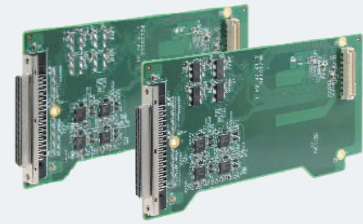

Key Features

- 4x RS-232/422/485 multi-mode ports
- 4x RS-232 ports (C180) or 4x RS-422/485 ports (C181)
- Up to 921.6 Kbps baud rate
- BIOS-configurable mode/termination settings
- Supports Windows 7/8/8.1/10
- SCSI-II 68-pin connector

Specifications

	MezIO®-C180	MezIO®-C181
# of Port	4x RS-232/ 422/ 485 4x RS-232	4x RS-232/ 422/ 485 4x RS-422/ 485
Baud Rate	50 bps to 921600 bps	
FIFO	256-byte TX and RX FIFOs	
ESD Protection	8 kV	
Interface Signals	RS-232: TxD, RxD, RTS, CTS, DTR, DSR, DCD, GND RS-422: TxD+, TxD-, RxD+, RxD-, GND RS-485: Data+, Data-, GND	
Connector	68-pin SCSI-II female connector	
OS Support	Windows 7/ 8/ 8.1/ 10 and Linux kernel 2.6.32 or later	

Ordering Information

Model No.	Product Description
MezIO®-C180-50	4x RS-232/ 422/ 485 and 4x RS-232 ports MezIO® module, for Nuvo-9000/ Nuvo-7000/ Nuvo-5000/ POC-500/ POC-400/ POC-300 Series
MezIO®-C181-50	4x RS-232/ 422/ 485 and 4x RS-422/ 485 ports MezIO® module, for Nuvo-9000/ Nuvo-7000/ Nuvo-5000/ POC-500/ POC-400/ POC-300 Series
Cbl-S68M-8DB9M-50CM	SCSI-68(M) to 8x DB-9(M) cable, 50 cm

MezIO®-V20 16-mode Ignition Power Control MezIO® Module

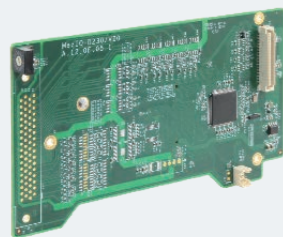

Key Features

- Ignition power control with 16 predefined on/ off delay modes
- Ultra-low 12 mA ignition-off standby power
- Advanced ignition control features
 - Low-battery protection
 - Guarded power-on/ power-off delay duration
 - System hard-off
 - BIOS POST check
- Supports 12V DC (small vehicle) and 24V DC (bus/ truck) vehicles

Ordering Information

Model No.	Product Description
MezIO®-V20-EP (Nuvo-9000E/P/DE/ Nuvo-7160GC/ Nuvo-7164GC/ Nuvo-7000E/P/DE/ Nuvo-5026E/ Nuvo-5000E/P Nuvo-5095GC)	16-mode ignition power control MezIO® module for in-vehicle usage
MezIO®-V20 (POC-500/ POC-400/ POC-300/ Nuvo-9000LP/ Nuvo-7000LP/ Nuvo-5000LP)	16-mode ignition power control and 1x mini-PCIe socket MezIO® module for in-vehicle usage

MezIO®-D230/ MezIO®-D220 32/ 16-CH Isolated Digital I/O MezIO® Module

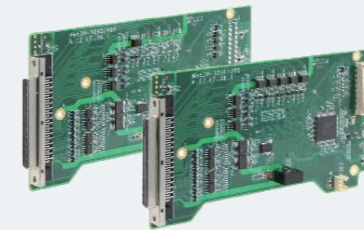

Key Features

- 16-CH isolated DI (D230) or 8-ch isolated DI (D220)
- 16-CH isolated DO (D230) or 8-ch isolated DO (D220)
- 2500 Vrms isolation voltage
- Up to 24V DC operation for DI and DO
- Up to 500 mA sink current on DO channel
- SCSI-II 68-pin connector

Specifications

	MezIO®-D230	MezIO®-D220
Isolated Digital Input		
# of Port	16	8
Logic Level	Logic high: 5 to 24 VDC ; Logic low: 0 to 1.5 VDC	
Isolation Voltage	2500 Vrms	
Operation Mode	Polling, COS	
Isolated Digital Output		
# of Channel	16	8
Operation Voltage	Up to 24 VDC	
Sink Current	500 mA for each channel (100% duty)	
Isolation Voltage	2500 Vrms	
Operation Mode	Polling, COS	

Ordering Information

Model No.	Product Description
MezIO®-D230-50	16-CH isolated DI and 16-CH isolated DO MezIO® module, for Nuvo-9000/ Nuvo-7000/ Nuvo-5000/ POC-500/ POC-300 Series
MezIO®-D220-50	8-CH isolated DI and 8-CH isolated DO MezIO® module, for Nuvo-9000/ Nuvo-7000/ Nuvo-5000/ POC-500/ POC-300 Series
Cbl-S68M-S68M-100CM	SCSI-68(M) to SCSI-68(M) cable, 100 cm
TB-10	Terminal board with 68-pin SCSI-II female connector and 68-pole terminal block

MezIO®-R10 2.5" SATA HDD/SSD and mini-PCIe Accommodation MezIO® Module

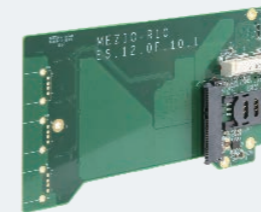

Key Features

- Accommodates one 2.5" SATA HDD/ SSD
- One full-size mini-PCIe port with SIM socket

Ordering Information

Model No.	Product Description
MezIO®-R11 (for POC-500/ POC-400/ POC-300 series only)	MezIO® module with 2.5" SATA HDD/ SSD
MezIO®-R12 (for POC-500/ POC-400/ POC-300 series only)	MezIO® module with SATA port for 2.5" HDD/ SSD, 4-CH isolated DI and 4-CH isolated DO

MezIO[®]-U4

4-Port USB 3.1 MezIO[®] Module



Key Features

- 4 x USB 3.1 ports by independent Renesas μ PD720202 Host Controllers
- Up to 5 Gbps each port (MezIO-U4-50)
- Support up to 900 mA per port

Specifications

	MezIO [®] -U4-30	MezIO [®] -U4-50
USB Ports	4x USB 3.1 ports, compatible with USB 2.0/1.1/1.0	
USB Controller	2 x Renesas μ PD720202 Host Controllers	4 x Renesas μ PD720202 Host Controllers
USB Connectors	4x USB 3.1 Type-A connectors	
USB Per-Port Current Limit	900mA	
Interface Signals	5 Gbps shared by two ports	5 Gbps for each port

Ordering Information

Model No.	Product Description
MezIO [®] -U4-30	4-port USB 3.1 MezIO [®] module for POC-400/ POC-300 series
MezIO [®] -U4-50	4-port USB 3.1 MezIO [®] module for POC-500 series, Nuvo-9000 Series, Nuvo-7000 series and Nuvo-5000 series



MezIO[®] - G4P/ MezIO[®] -G4

4-Port GbE with 802.3at PoE+ MezIO[®] Module

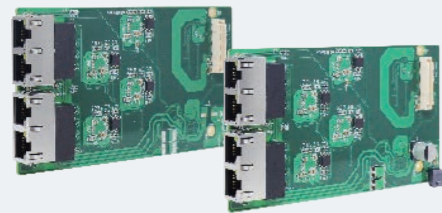

Key Features

- 4x gigabit Ethernet ports
- Compliant with 802.3at PoE+ (MezIO-G4P)
- Supporting 9.5 KB jumbo frame

Specifications

	MezIO [®] - G4P	MezIO [®] - G4
Gigabit Ethernet Port	4x GigE ports by 4x Intel [®] I210 controllers, supporting 9.5 kB jumbo frame	
PoE Capability	Compliant with IEEE 802.3at-2009 (PoE+), each port delivers up to 25.5 W of power	-
Cable Requirement	CAT-5e or CAT-6 cable, 100 meters maximum	

Ordering Information

Model No.	Product Description
MezIO [®] - G4P	4-Port GbE with 802.3at PoE+ MezIO [®] module for Nuvo-9000/ Nuvo-7000/ Nuvo-5000 series
MezIO [®] - G4	4-Port GbE MezIO [®] module for Nuvo-9000/ Nuvo-7000/ Nuvo-5000 series

Accessories

List of Optional Cable

Cable	Model Name	Description	Applicable Models
	Cbl-W210F-W210F-100CM	Remote control cable, 2x5 Pin female wafer to 2x5 Pin female wafer length: 100CM	<ul style="list-style-type: none"> Nuvo-5000 series Nuvo-5095GC series Nuvo-5100VTC series Nuvis-5306RT series Nuvo-5608VR
	Cbl-IDC220F-2U2TA-15CM	USB cable, 2x USB(female) to PIN header(20 pin, female), for internal USB port connectivity, length: 15CM	<ul style="list-style-type: none"> Nuvo-8000 series Nuvo-6000 series
	Cbl-U3TA-U3MB-Latch-300CM	USB3 Type-A to Micro-B cable with latched connectors, Length: 300CM	<ul style="list-style-type: none"> Nuvo-9000 series Nuvo-7000 series Nuvo-7100VTC series Nuvo-7200VTC series Nuvis-7306RT series Nuvis-534RT series POC-700 series POC-500 series POC-400 series POC-551VTC POC-451VTC RGS-8805GC Nuvo-10208GC Nuvo-8208GC Nuvo-8108GC/8108GC-XL Nuvo-8108GC-QD Nuvo-8240GC Nuvo-9160GC series Nuvo-7160GC series Nuvo-8034
	Cbl-U3TA-U3TA-Latch-300CM	USB cable, USB 3.0-A Male with latched to USB 3.0-A Male, Length: 300CM	<ul style="list-style-type: none"> Nuvo-9000 series Nuvo-7000 series Nuvo-7100VTC series Nuvo-7200VTC series Nuvis-7306RT series Nuvis-534RT series POC-700 series POC-500 series POC-400 series POC-551VTC POC-451VTC RGS-8805GC Nuvo-10208GC Nuvo-8208GC Nuvo-8108GC/8108GC-XL Nuvo-8108GC-QD Nuvo-8240GC Nuvo-9160GC series Nuvo-7160GC series Nuvo-8034
	Cblbr-IDC220F-2U2TA-26.5CM	USB cable, 2x1- Pin header to 2x USB 2.0 with bracket.	<ul style="list-style-type: none"> Nuvo-8000 series Nuvo-6000 series
	Cbl-Pwr4-W2.54F-20CM	Power cable, 4 PIN power connector to wafer 2.5 4P Female, provide 12V to add-on card, length: 20CM	<ul style="list-style-type: none"> Nuvo-9000E/DE/P series Nuvo-7000E/DE/P series Nuvo-5000E/P series
	Cbl-S68M-S68M-100CM	SCSI-68 (male) to SCSI-68M (male) cable, for MeziO DIO card and TB-10, length: 100CM	<ul style="list-style-type: none"> MeziO-D220 MeziO-D230 Nuvis-5306RT series Nuvis-534RT series
	Cbl-S68M-8DB9M-50CM	SCSI-68 (male) to 8x DB9 (male) Cable, for MeziOCOM port card, length: 50CM	<ul style="list-style-type: none"> MeziO-C180 MeziO-C181
	Cbl-DB9F-3DB9M-15CM	1x DB9 (female) to 3x DB9 (male), length: 15CM	<ul style="list-style-type: none"> Nuvo-8000 series Nuvo-6000 series POC-300 series POC-500 series
	Cbl-DVII-DVIL-VGA-Y-20CM	DVI-I to DVI-D/VGA splitter Y cable, length: 20CM	<ul style="list-style-type: none"> POC-300 series
	Cbl-DVID-VGA-15CM	DVI-D to VGA cable, for Nuvo-8000/ Nuvo-6000 series, length: 15CM	<ul style="list-style-type: none"> Nuvo-8000 series Nuvo-6000 series

Cable	Model Name	Description	Applicable Models
	Cbl-RJ45-RJ45-Latch-1000CM	LAN Cable, RJ45(Male) with latched connector to RJ45(Male), Cat6, Length: 1000CM	<ul style="list-style-type: none"> Nuvo-9000 series Nuvo-9501 series Nuvo-9531 series Nuvo-7000 series Nuvo-7100VTC series Nuvo-7200VTC series Nuvis-7306RT series Nuvis-534RT series Nuvo-9160GC series Nuvo-7160GC series Nuvo-7501/7505D Nuvo-7531 POC-700 series POC-500 series POC-551VTC POC-400 series RGS-8805GC NRU-220S NRU-120S/110V NRU-52S/51V
	Cbl-M12X8M-RJ45-CAT6A-500CM	M12(8-pole-X-coded) to RJ45, CAT6A, Length : 500CM	<ul style="list-style-type: none"> SEMIL-1700GC series SEMIL-1700 series SEMIL-1300GC series SEMIL-1300 series
	Cbl-M12X8M-RJ45-500CM	M12(8-pole-X-coded) to RJ45, CAT6, length : 500CM	<ul style="list-style-type: none"> Nuvo-7100VTC series Nuvo-7200VTC series Nuvo-7300VTC series Nuvo-5100VTC series Nuvo-2610VTC series Nuvo-2615RL series
	Cbl-M12X8M-RJ45F-100CM	M12(8-pole-X-coded) to RJ45 Female, CAT6A, Length : 100CM	<ul style="list-style-type: none"> POC-465AWP
	Cbl-M12A8M-2U2TA-180CM1	M12(8-pole-A-coded) to 2xUSB 2.0 type A (female), Length: 180CM	<ul style="list-style-type: none"> SEMIL-1700GC series SEMIL-1700 series SEMIL-1300GC series SEMIL-1300 series POC-465AWP
	Cbl-M12A17M-VGA-180CM2	M12(17-pole-A-coded) to VGA (Male), Length: 180CM	<ul style="list-style-type: none"> SEMIL-1700GC series SEMIL-1700 series SEMIL-1300GC series SEMIL-1300 series POC-465AWP
	Cbl-M12A17M-2DB9M_OW2-180CM1	M12(17-pole-A-coded) to 2xDB9 (Male) and 1xopen wire 2P, Length: 180CM	<ul style="list-style-type: none"> SEMIL-1700GC series SEMIL-1700 series SEMIL-1300GC series SEMIL-1300 series
	Cbl-M12A8M-2DB9M-180CM	M12(8-pole-A-coded male) to 2x DB9 male, Length: 180CM	<ul style="list-style-type: none"> POC-465AWP
	Cbl-M12A8M-ADJ-180CM	M12(8-pole-A-coded) to Audio Jack, Length : 180CM	<ul style="list-style-type: none"> SEMIL-1700GC series SEMIL-1700 series SEMIL-1300GC series SEMIL-1300 series
	Cbl-M12A5F-OW3-180CM	M12(5-pole-A-coded Female) to 3P cord end terminal, Length : 180CM	<ul style="list-style-type: none"> POC-465AWP
	Cbl-M12S4F-OW4-180CM1	M12(4-pole-S-coded) to open wire 4P, Length: 180CM	<ul style="list-style-type: none"> SEMIL-1700GC series SEMIL-1700 series

Index

A

Accessories 194

I

IGT-33V/ IGT-34C 92
IGT-30D/ IGT-31D 94
IGT-20/ IGT-21/ IGT-22 96

L

LTN-450 106

M

MezIO 190

N

NRU-110V 132
NRU-51V 134
NRU-120S 144
NRU-220S 142
NRU-52S 146
Nuvis-5306RT 102
Nuvis-534RT 104
Nuvis-7306RT 100
Nuvo-10208GC 154
Nuvo-2600 60
Nuvo-2610VTC 122
Nuvo-2615RL 124
Nuvo-2700DS 70
Nuvo-5000E/ P/ DE 52
Nuvo-5000LP 54
Nuvo-5026E 56
Nuvo-5095GC 176
Nuvo-5100VTC 120
Nuvo-5501 58
Nuvo-5608VR 148
Nuvo-6000 68
Nuvo-6108GC/ Nuvo-6108GC-IGN 166
Nuvo-7000E/P/DE 44
Nuvo-7000LP 46
Nuvo-7100VTC 118
Nuvo-7200VTC 114
Nuvo-7250VTC 116
Nuvo-7501 48
Nuvo-7531 50
Nuvo-7160GC 174
Nuvo-7164GC/ Nuvo-7166GC 172
Nuvo-7168GC 170
Nuvo-8000 64

Nuvo-8108GC 162
Nuvo-8108GC-XL 158
Nuvo-8108GC-QD 160
Nuvo-8111 66
Nuvo-8208GC 156
Nuvo-8240GC 164
Nuvo-8034 62
Nuvo-9000 36
Nuvo-9160GC 168
Nuvo-9531 40
Nuvo-9501 42

P

PB-2500J 90
PB-9250J/ PB-4600J 88
PB-9250J-110V 86
PCIe-GL26 136
PCIe-NX154PoE 138
PCIe-NX156U3 139
PCIe-PoE312M 140
PCIe-PoE334LP 110
PCIe-PoE354at/ 352at 111
PCIe-PoE425bt 150
PCIe-PoE454 108
PCIe-PoE550X 109
PCIe-USB381F 112
POC-300 80
POC-351VTC 130
POC-40 78
POC-400 76
POC-451VTC 128
POC-465AWP 82
POC-500 74
POC-551VTC 126
POC-700 72

R

RGS-8805GC 152

S

SEMIL-1300 186
SEMIL-1300GC 184
SEMIL-1700 182
SEMIL-1700GC 180

Worldwide Office

Neusys Technology Taipei Headquarter

15F, No.868-3, Zhongzheng Rd.,
Zhonghe Dist., New Taipei City, 23586, Taiwan
TEL: +886-2-22236182 FAX: +886-2-22236183
Email: sales@neusys-tech.com

Neusys Technology America, Inc.

3384 Commercial Avenue,
Northbrook, IL 60062, USA
TEL: +1-847-656-3298
Email: sales@neusys-tech.com

Neusys Technology China Co., Ltd.

Room 429, Building 33, No.680, Guiping Road,
Shanghai, 200233, China
TEL: +86-2161155366
Email: sales@neusys.cn

www.neusys-tech.com

